

Windows® Phone 8X by **HTC**

User guide

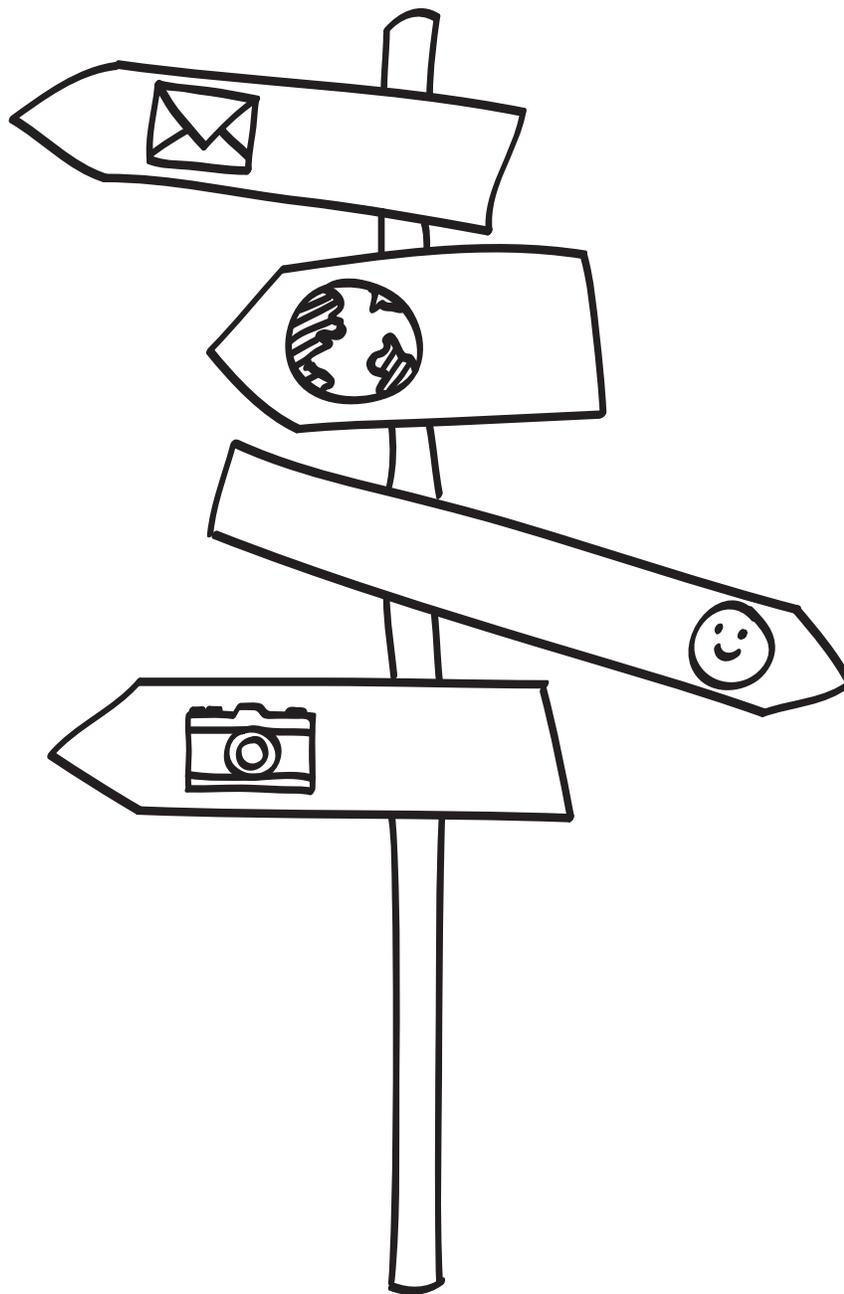

Contents

Unboxing

Your phone	8
SIM card	9
Battery	11
Switching the power on or off	12

Setting up your phone

Entering your PIN	13
Setting up your phone for the first time	13
Account setup	13
Getting contacts into your phone	14

Your first week with your new phone

Features you'll enjoy	15
Start screen	16
Touch gestures	17
Motion gestures	19
Adjusting the volume	20
Sleep mode	21
Lock screen	21
Changing the ringtone	22
Changing the theme	23
Taking a screenshot	23
Switching between apps	23
Windows Store	24
Using speech on your phone	24

Camera

Camera basics	26
Taking a photo	27
Recording video	28
After capturing	28

Phone calls

Making a call	29
Receiving calls	30
What can I do during a call?	30
Starting a conference call	31
Call history	32

Turning airplane mode on or off	33
---------------------------------	----

People

Keeping in touch	34
Importing contacts from your SIM card	34
Adding a new contact	34
Jumping to a section in the contacts list	35
Filtering your contacts list	35
Merging contact profiles	35
Searching, editing or deleting	36
Sharing with a group of contacts in real-time	37
Organizing your contacts into groups	38
What is the Me tile?	40
Posting to social networks	40
Filtering social updates	41

Keyboard

Using the onscreen keyboard	42
Entering words with predictive text	43
Changing the keyboard language	43

Messaging

Texting and chatting in one place	44
Sharing pictures, videos, and more in a message	45
Viewing and replying to a message	46
Managing conversations	47

Email

Adding your Microsoft account	48
Adding a POP3/IMAP email account	48
Adding a Microsoft Exchange ActiveSync account	49
Checking email	49
Sending email	50
Managing email messages	51
Changing email account settings	52

Photos, videos, and music

Photos	53
Music + Videos	55

Sync and Backup

Keeping things in sync	56
Backing up your files	56

Internet connections

Data connection	57
Wi-Fi	58
Using your phone as a mobile hotspot	60

Search and Web browser

Ways you can search the Web	61
Searching for information	61
Scanning codes, tags, and text	62
Opening and navigating web pages	64
Music search	65

Maps and location

Location services	66
Maps	66
Local Scout	69

Calendar

What you can do in Calendar	71
Creating a calendar appointment	71
Creating a new to-do task	72
Displaying and syncing calendars	73

More apps

What can I do in the HTC hub?	74
What's in the Office hub?	79
Xbox LIVE in the Games hub	80

Bluetooth and NFC

Connecting a Bluetooth accessory	81
Disconnecting a Bluetooth accessory	81
Unpairing	82
Sharing content with NFC	82
Turning NFC on and off	82
Using NFC	83

Settings

Attentive phone features	84
Turning Battery Saver on	84
Changing display settings	85
Changing sound settings	85
Managing apps and storage	86

Security

Protecting your SIM card with a PIN	87
Protecting your phone with a password	87
Making your phone safe for kids	88
Setting up Kid's Corner	88
Launching Kid's Corner	88
Closing and disabling Kid's Corner	89

Update and reset

How to get and install updates	90
Preparing for a software update	90
Installing an update	91
Factory reset	91

Trademarks and copyrights

Index

Conventions used in this guide

In this user guide, we use the following symbols to indicate useful and important information:



This is a note. A note often gives additional information, such as what happens when you choose to do or not to do a certain action. A note also provides information that may only be applicable to some situations.



This is a tip. A tip gives you an alternative way to do a particular step or procedure, or lets you know of an option that you may find helpful.



This indicates important information that you need in order to accomplish a certain task or to get a feature to work properly.



This provides safety precaution information, that is, information that you need to be careful about to prevent potential problems.

Other helpful resources

For health, safety, and regulatory information, please read the Safety and regulatory guide that's included in the box.

In addition to this user guide, you can find help information, FAQs, and more in www.htc.com/support.

To learn a lot more about using Windows® Phone, open **Help+Tips** on your phone. Or use your web browser and go to windowsphone.com.



Certain Windows Phone features or Microsoft® services may not be available in some countries or regions.

Unboxing

Your phone

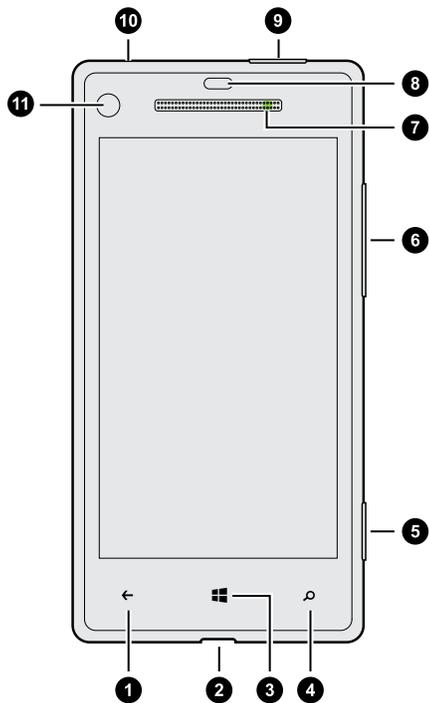

1. BACK
2. USB connector
3. START
4. SEARCH
5. Camera button
6. VOLUME
7. Notification LED
8. Proximity sensor
9. POWER
10. 3.5mm headset jack
11. Front camera



If you want to use a screen protector, please don't cover and block the proximity sensor. You can purchase the dedicated screen protector for your phone that already has a small opening for the sensor.

SIM card

The SIM card contains your phone number, service details, and memory for storing phonebook contacts and/or text messages.

Inserting the SIM card

1. Insert the SIM eject tool (or a small bent paperclip) into the small hole next to the SIM card tray.

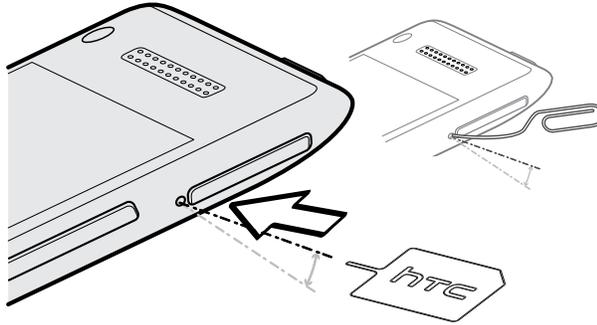

2. Pull the SIM card tray out, and place the SIM card (contacts facing down) into the tray.

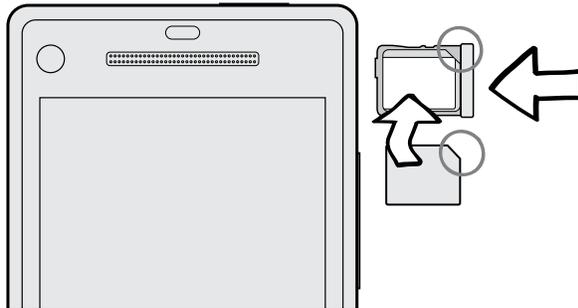

3. Insert the SIM card tray into its slot.

Removing the SIM card



Make sure to switch off your phone before removing your SIM card.

1. Insert the SIM eject tool (or a small bent paperclip) into the small hole next to the SIM card tray.
2. Pull the SIM card tray out and remove the SIM card.

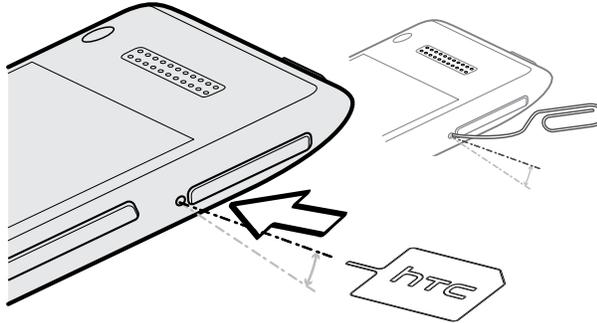

Battery

Your phone uses a rechargeable, non-removable battery. How long the battery can last before it needs recharging depends on how you use your phone. The features and accessories you use can affect battery life. For example, leaving your Bluetooth® connection always on uses more power. Long phone calls and frequent web browsing use up a lot of battery power. Also, consider your location: poor signal strength from your mobile network and extreme temperature make the battery work harder.

Charging the battery

Before you turn on and start using your phone, it is recommended that you charge the battery.



Only the power adapter and USB cable provided in the box must be used to charge the battery.

1. Insert the small end of the USB cable into the USB connector.

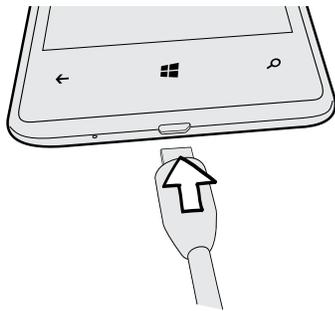

2. Insert the other end of the USB cable into the power adapter.
3. Plug in the power adapter to an electrical outlet to start charging the battery.

As the battery is being charged, the notification LED shows a solid red light. The light turns to solid green when the battery is fully charged.

When you charge the battery and the phone is on, the charging battery icon  is displayed in the status bar. After the battery has been fully charged, the charging battery icon turns to a full battery icon .



As a safety precaution, the battery stops charging when it overheats.

Switching the power on or off

Switching the power on

Press the POWER button. Easy.



When you turn on your phone for the first time, you'll need to set it up.

Switching the power off

1. If the display is off, press the POWER button to turn it back on, then unlock the screen.
2. Press and hold the POWER button until you see the message, `slide down to power off`.
3. Swipe your finger down the screen.

Phone not responding?

Restart your phone if it doesn't respond when you touch the screen or press the buttons.

Press and hold the POWER button for at least 12 seconds. Your phone turns off and then turns back on.

Setting up your phone

Entering your PIN

Some SIM cards come with a PIN (personal identification number) set by your mobile operator.

If you're asked for a PIN, enter it and then tap **enter**.



If you enter the wrong PIN three times, the SIM card is blocked. If this happens, you can unblock it with the PUK (PIN Unlocking Key) obtained from your mobile operator.

Setting up your phone for the first time

When you switch on your phone for the first time, you'll be asked to set it up. Just follow the onscreen instructions and you'll be up and running in no time.

Be sure to sign in with your Microsoft account so you can use services such as Windows Store, Xbox LIVE®, and more.

Account setup

Set up your online accounts so you can send and receive email, and more.

Depending on the type of email account that you set up, other items such as contacts, calendar, or other information can appear on your phone as well. And when you sign in to your social networking accounts, you'll also get your friends' status updates and see the pictures they've posted.

Setting up an account

1. On the Start screen, slide to the left.
2. Tap **Settings > email+accounts**.
3. Tap **add an account**, and then tap the type of account you want to set up.

Syncing an account

If you're not seeing your most recent email messages or status updates in an account, you can manually sync the account to download them.

1. On the Start screen, slide to the left.
2. Tap **Settings** > **email+accounts**.
3. Press and hold the account whose information you want to download, and then tap **sync**.

Deleting an account

1. On the Start screen, slide to the left.
2. Tap **Settings** > **email+accounts**.
3. Press and hold the account you want to delete, and then tap **delete**.



Your primary Microsoft account cannot be deleted. You'll need to do a factory reset to remove it.

Getting contacts into your phone

There are several ways you can add contacts to your phone.

Online accounts	Log in to your online accounts to import contact information.
Phone contacts	Create and store contacts directly in your phone.
SIM card	Copy your SIM contacts to your phone.
Outlook® (Exchange ActiveSync®)	Sync your work contacts with Outlook (Exchange ActiveSync).
Bluetooth	Receive contacts via Bluetooth from another phone.

Your first week with your new phone

Features you'll enjoy

Keep up to date with your family and friends, and share what's going on in your life. Hear what you've been missing in your music. And more.

Make your phone as unique as you are

Personalize your Start screen with what's important and unique to you. Create live tiles for your favorite people, music albums, apps, and more, and pin them all to your Start screen. To find out more, see [Start screen](#) on page 16.

Capture every moment

Here are some of the great camera features you can use:

- With the ultra-wide angle front camera, you can take a picture of yourself and more of the beautiful landscape behind you. Or take a close up shot with family or friends.
- Quickly launch your camera with the dedicated CAMERA button, even when your phone is in sleep mode.
- Use your camera in a wide variety of environments, even in low light conditions.

To find out how to do these and more, see [Camera](#) on page 26.

Beats By Dr. Dre Audio™

Beats Audio™ integration gives you a rich, authentic sound experience, whether you're listening to music, watching a video, or playing a game. To find out more, see [Making your music sound better](#) on page 55.

SkyDrive integration

Always have access to your photos, videos, and documents anywhere by storing them in SkyDrive®. See [Sharing](#) on page 54.

Start screen

Up front on the Start screen, you'll see live tiles that continuously update and show what's most personal to you. You'll see your photo album, how many new text and email messages you have, and more.

- Simply swipe your finger up or down to scroll through the tiles.
- Swipe your finger left to access apps and settings. Tap a letter tile to see all of the alphabet tiles.
- To return to the Start screen from any screen, press .

Rearranging and resizing tiles

1. Press and hold the tile you want to move until it floats.
2. Tap the arrow in the lower right corner to resize the tile.
3. Drag the tile where you want it to go.
4. When you're done moving tiles, press  or .

Pinning items to the Start screen

You can pin just about anything you want to the Start screen: apps, pictures, songs, favorite websites, documents, and even contacts.

For example, when you pin a contact to the Start screen, you'll get all of that person's updates — feeds, email, text messages, and call notifications — right from that tile.

1. To pin something, press and hold it until a menu appears.
2. Tap **pin to start**.

Unpinning a tile

1. Press and hold the tile you want to remove.
2. Tap .

Touch gestures

Use touch gestures to get around your phone.

Tap

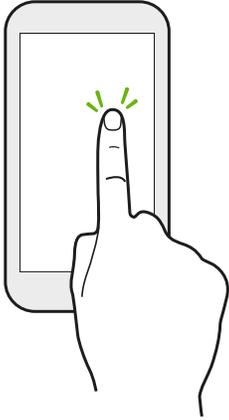

When you want to type on the keyboard, select onscreen items such as application and settings icons, or press onscreen buttons, just tap them with your finger.

Press and hold



Press and hold an item to view available options (for example, additional keys on the keyboard).

Swipe or slide

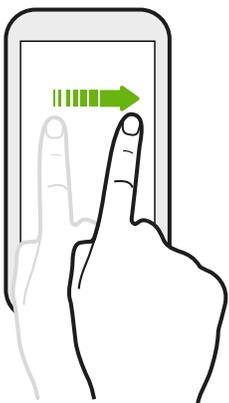

Swipe your finger vertically or horizontally across the screen when you need to scroll through a long list or see other screens in a hub.

Drag

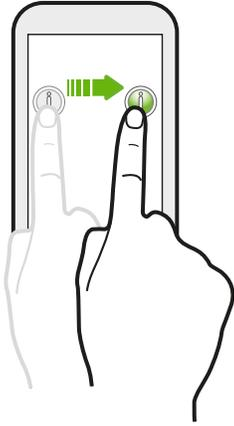

Press and hold your finger with some pressure before you start to drag. While dragging, don't release your finger until you have reached the target position.

Flick



Flicking the screen is similar to swiping, except that you need to swipe your finger in light, quicker strokes, such as when moving from the Start screen to the apps list.

Pinch and spread

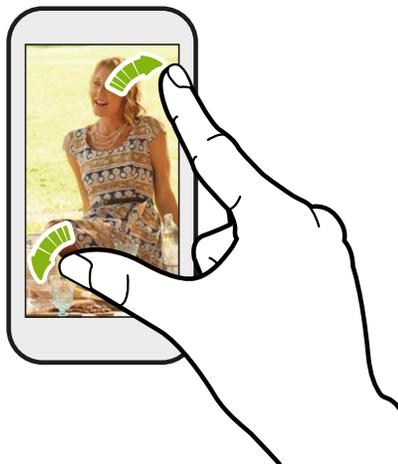

In some apps, such as Photos or Internet Explorer, spread your fingers on the screen to zoom in when viewing a picture or text.



Pinch the screen to zoom out of the picture or text.

Motion gestures

Use motion gestures to mute the ringer and more.

Flip to silence

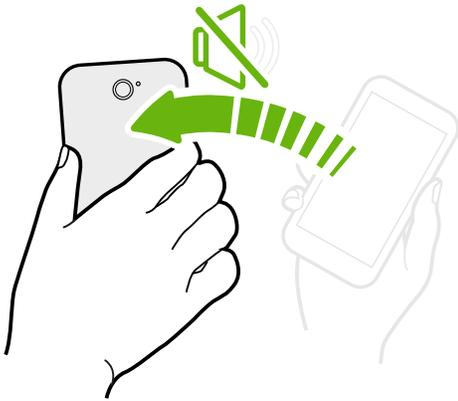

When a call comes in you can turn your phone over to mute it.

Pick up to lower volume



In a business meeting or restaurant, pick your phone up when a call comes in to lower the ringtone volume.

Set volume to automatically rise while in your pocket or bag



On a noisy street and can't hear your phone ringing in your bag?

You can set your phone to automatically detect when it's in your bag or pocket and raise the ringtone volume so that you can hear it in noisy environments.

Rotate your phone for a better view

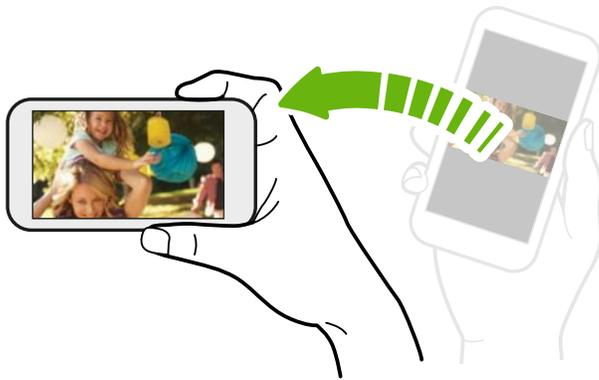

For many screens, you can automatically change the screen orientation from portrait to landscape by turning your phone sideways.

When entering text, you can turn your phone sideways to bring up a bigger keyboard.

Adjusting the volume

1. Press the VOLUME UP or VOLUME DOWN button to make the volume bar appear.
2. Keep pressing until you get the volume level that you want.

Silencing your ringer

1. Press the VOLUME UP or VOLUME DOWN button to make the volume bar appear.
2. Tap .

If the **Vibrate** option is on in the settings, your phone will change to vibrate mode. If it's not, your phone will change to silent mode.

Sleep mode

Sleep mode saves battery power by putting your phone into a low power state while the display is off. It also stops accidental button presses when your phone is in your bag or pocket. You'll still receive messages and calls though.

Switching to Sleep mode

Briefly press the POWER button to turn off the display and switch to Sleep mode. Your phone also automatically goes into Sleep mode when it's idle for a while.

Waking up from Sleep mode

To wake your phone up manually, press the POWER button. You'll need to unlock the screen.



Your phone automatically wakes up when you have an incoming call.

Lock screen

Unlocking the screen

Swipe your finger up to unlock the screen or answer an incoming call.



If you've set up a password in the settings, you'll need to enter it to unlock the screen.

Changing your lock screen wallpaper

Browse the collection of preset wallpapers or choose from photos that you've taken with the camera.

1. On the Start screen, slide to the left.
2. Tap **Settings** > **lock screen**.
3. Tap the **Background** box and then choose **photo**.
4. Tap **change photo** and select a photo from your albums or tap  to take a new photo.
5. If the photo you selected is bigger than the allowable wallpaper size, crop the photo.

To crop, drag the photo and position the part that you want to be your wallpaper inside the crop box, and then tap .

Customizing your lock screen notifications

Get a quick glance of important notifications right on your lock screen.

1. On the Start screen, slide to the left.
2. Tap **Settings** > **lock screen**.
3. Choose an app for detailed notifications.
4. Choose up to five apps for quick notifications.
5. When you're done, press  or .

Changing the ringtone

Choose from the preset ringtones.

1. On the Start screen, slide to the left.
2. Tap **Settings** > **ringtones+sounds**.
3. Tap the **Ringtone** box.
4. Listen to a ringtone by tapping the play icon beside its name.
5. Tap the ringtone you want to use.

Changing the theme

Feeling a little blue? You can change the screen's background and accent colors to match your mood. The accent color you choose will appear in various places, like the tiles on the Start screen, app icons, on web links, in messages, and more.

1. On the Start screen, slide to the left.
2. Tap **Settings > theme**.
3. Choose the background and accent colors that you like by tapping their respective boxes.

Taking a screenshot

Want to show off your high game score, write a blog post about your phone's features, or post a status update about a song you're playing? It's easy to take a picture of the screen.

Press and hold **POWER** and then quickly press . The screen is saved in the **screenshots** album in the Photos hub.

Switching between apps

Many apps can run at the same time, and there's an easy way to switch between them all.

1. Press and hold  to see what apps are currently running.
2. Slide left or right across the screen to see all of the open apps, and then tap the one you want to use.

Windows Store

In Windows Store, it's easy to download and purchase apps that fit your needs. A wide collection of free and paid apps is available, from everyday apps, powerful business apps, to fun games. You can also purchase songs.

From the Start screen, slide to the left and tap **Store** to start shopping.

Using speech on your phone

Make a call, send a text, or find a place by simply using your voice.



The speech feature may not be available in some countries or regions.

1. Press and hold .

If this is your first time using the speech feature, the screen will display some examples of things you can say. After reading the examples, tap **accept**.

2. Say an instruction, for example:
 - To call someone in your contact list, you can say `Call Jennifer Singer, mobile`.
 - To open an app such as Calendar, say `Open Calendar`.
 - To search for something on the Web such as pizza parlors, you can say `Find pizza parlors`.
 - If you need help, say `What can I say?` to view or listen to the various types of voice instructions you can use.

Turning on more speech commands

You can turn on additional speech commands in the settings, such as saving and dialing speed dial numbers. You can also set your phone to read aloud text messages and allow you to dictate your reply message without typing.

1. On the Start screen, slide to the left.
2. Tap **Settings** > **ease of access**.
3. Tap the **Speech for phone accessibility On/Off** switch to turn on additional speech commands for phone calls. You'll be able to use these commands:

Save speed dial	To assign a speed dial number
Call <i>number</i>	To call a speed dial number
Turn call forwarding on/off	To turn call forwarding on or off

4. Press  to return to the settings list.
5. Tap **speech**.

6. Make sure the **Play audio confirmations** switch is turned on. This makes your phone speak aloud to inform you of incoming phone calls.
7. To make your phone read text messages to you, tap the **Read aloud incoming text messages** box. Choose whether you want your phone to read text messages all the time, or only when you're using a Bluetooth or wired headset.

Camera

Camera basics

Whether traveling for business or fun, enjoy taking photos and videos with the camera.

- From the Start screen, slide left and then tap **Camera** to open the Camera app.
- Or press the CAMERA button.



Did you know you can open the Camera app even if the display is off or locked? Just press and hold the CAMERA button.

Viewfinder screen

You'll find the following onscreen controls on the Viewfinder screen:

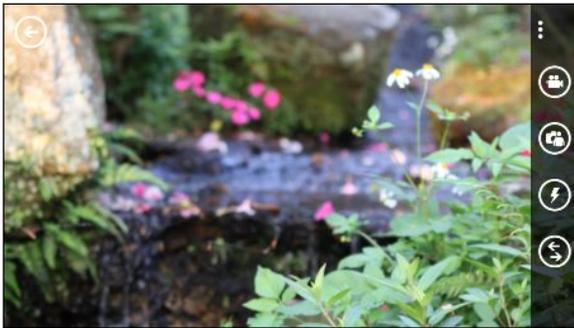

	Photo/Video mode
	Front/Main camera mode
	Flash mode
	Video light
	Camera lenses
	Go to the camera roll



Flash and video light are not available when:

- You're using the front camera.
- The battery power is too low.

Zooming

Before taking a photo or video, you can zoom in or out of your subject.

Simply spread or pinch on the screen to zoom in or out.

Changing settings

1. Tap **⋮** > **photo settings** or **video settings** to choose from various resolutions.
2. To save your settings, tap **save** after you make the change.



To find more camera settings slide left from the **Start** screen and then tap **Settings**. Then slide to the **applications** list and tap **photos+camera**.

Taking a photo

1. Open the Camera app.
2. Choose your camera settings:
 - Tap  to set the camera to auto flash, flash on, or flash off.
 - Tap  to switch to the ultra wide angle front camera for a group shot of you and your friends.
 - Tap  to select or download lenses.
 - Tap **⋮** > **photo settings** to choose the resolution you want to use.
3. Hold your phone steady, either vertically (portrait view) or horizontally (landscape view).
4. Before taking the photo, you can zoom in and out.
5. To take the photo, you can:
 - Press the CAMERA button halfway down to focus, and then press the button all the way down to take the photo. The camera will auto focus on what's in the center of the screen.
 - Or tap any point on the screen to focus there and take the photo.

The photo will be saved in the **Camera Roll** album of the Photos hub.

Recording video

You can record videos in either portrait or landscape orientation. For the best viewing experience of your videos, the most ideal way is to capture them in landscape.

1. Open the Camera app.
2. Tap  to switch to video mode. You'll see a video counter on the screen.
3. Choose your video recording settings:
 - Tap  to set the video light to be on or off during the recording.
 - Tap  to switch to the ultra wide angle front camera.
 - Tap **⋮** > **video settings** to choose the resolution you want to use.
4. Before recording, you can zoom in and out.
5. Press the CAMERA button to start recording.
6. To stop recording, press CAMERA again.

The video will be saved in the **Camera Roll** album of the Photos hub.

After capturing

After taking a photo or video, you can view it and others you've captured without leaving the Camera app. You can also choose what to do with a photo or video, such as upload it to SkyDrive or share it on a social network.

1. While on the Viewfinder screen, tap . Or slide your finger on the screen.
You'll see the photo or video you last captured.
2. If it's a photo, double-tap or pinch and stretch if you want to zoom in and out of a photo.
If it's a video, just tap the play icon to view the recording.
3. Tap **⋮** to see options of what you can do with your photo or video.
4. Pinch the screen to change to filmstrip view. You can then easily flick left or right onscreen to browse through your photos and videos.
5. To continue capturing, slide your finger left if you're holding the phone horizontally (or slide up if holding the phone vertically) until you're back on the Viewfinder screen.

Phone calls

Making a call

 Some SIM cards come with a PIN (personal identification number) set by your mobile operator. If you're asked for a PIN, enter it and then tap **OK**. If you enter the wrong PIN three times, your SIM card is blocked. Don't worry. Just contact your mobile operator and ask for the PUK (PIN Unblocking Key).

1. On the Start screen, tap .
2. Tap  to open the keypad.
3. Enter the number you want to call and then tap **call**.

To hang up, tap **end call**.

 If you're ready to hang up but the Phone dialer screen isn't displayed anymore, tap the notification at the top of the screen, and then tap **end call**.

Making an emergency call

In some regions, you can make emergency calls even if you don't have a SIM card installed or your SIM card has been blocked.

1. On the Start screen, tap .
2. Tap  to open the keypad.
3. Dial the emergency number for your locale and then tap **call**.

 If you enabled your password but forgot it, you can still make an emergency call without entering the password by tapping **emergency call** on the lock screen and then dialing the local emergency number.

Making an international call

1. On the Start screen, tap .
2. Tap  to open the keypad.
3. Press and hold the **0** key until the + sign appears.

The plus sign (+) shows that you're making an international call (instead of entering the international access number for the country you're in).

4. Enter the following on the keypad:
 - Country or region code
 - Area code (without the 0 at the beginning)
 - Phone number
5. Tap **call**.

Receiving calls

When you receive a phone call, the **Incoming call** screen appears.

Answering a call

- Tap **answer**.
- Or if the display is off and wakes up when you get a call, slide up from the bottom to unlock the screen first and then tap **answer**.

Rejecting a call

- Tap **ignore**.
- Or if the display is off and wakes up when you get a call, slide up from the bottom to unlock the screen first and then tap **ignore**.

Muting the ringing sound without rejecting the call

Do one of the following:

- Place your phone face down on a level surface.



If your phone is already facing down, it will still ring when there are subsequent incoming calls.

- Press the VOLUME UP or VOLUME DOWN button.
- Press the POWER button to silence the ringer and turn the display off.

What can I do during a call?

When a call is in progress, use the onscreen buttons to turn the speaker on, put the call on hold, and more.

Turning the speaker on during a call



To decrease potential damage to your hearing, do not hold your phone against your ear when the speaker is on.

On the call screen, tap **speaker**.

To turn the speaker off, just tap **speaker** again.

Putting a call on hold

On the call screen, tap **hold**.

To resume the call, tap **hold** again.

Switching between calls

If you're already in a call and accept another call, you can choose to switch between the two calls.

1. When you receive another call, tap **answer** to accept the second call and put the first call on hold.
2. To switch between the calls, tap the bar at the top of the screen.

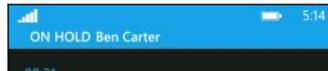

3. To end the current call and return to the other call, tap **end call**.

Muting the microphone during a call

On the call screen, tap **mute**.

To turn the microphone back on, tap **mute** again.

Starting a conference call

Conference calling with your friends, family, or co-workers is easy. Make the first call (or accept a call), and then simply dial each subsequent call to add it to the conference.



- Make sure your SIM card has conference calling service enabled. Contact your mobile operator for details.
- The maximum number of people you can have on a conference call varies by mobile operator.

1. Make a call to the first conference call participant.
2. When connected, tap **add call**, and then call the second participant.
The first participant is then put on hold.
3. When connected to the second participant, tap **merge calls**.
4. To add another participant, tap **add call**, and then call the person you want to invite.

5. When connected, tap **merge calls**.
6. To have a private conversation with someone in the call, tap **private**, and then tap the person's name or number.
 - Tap **merge calls** to merge the other people back and continue the conference call.
 - Or to end the private conversation, tap **end call**.

To end the conference call, tap **end call**.

Call history

Access the call history to check missed calls, your dialed numbers, and received calls.

Checking calls in the call history

1. On the Start screen, tap .
2. In the **history** list, you can:
 - Press and hold a number or contact name and delete it.
 - Tap a number or contact name to go to the **profile** list where you can choose to return the call, send a text message, save the number (if it's not yet stored in your contacts), and more.

Adding a new phone number from the call history to your contacts

1. On the Start screen, tap .
2. Tap the phone number that you want to save and then tap .
3. Tap  to create a new contact.
4. Edit the number if you need to, select the phone number type, and then tap .
5. Add the contact name and other information and then tap .



You can also save a phone number from the call history to an existing contact.

Clearing the call history

In the **history** list, you can:

Remove a number or name	Press and hold the number or name, and then tap delete item .
-------------------------	--

Clear the entire history	Tap ••• > delete all .
--------------------------	----------------------------------

Turning airplane mode on or off

In many countries, you are required by law to turn off wireless devices while on board an aircraft. A quick way to turn off wireless functions is to switch your phone to airplane mode.

When you enable airplane mode, all wireless radios are turned off, including the call function, data services, Bluetooth, and Wi-Fi®. When you disable airplane mode, the call function is turned back on and the previous states of Bluetooth and Wi-Fi are restored.

1. On the Start screen, slide to the left.
2. Tap **Settings > flight mode**.
3. Tap the **Status** switch to turn it on or off.

When airplane mode is on, you'll see the  icon in the status bar.

People

Keeping in touch

The People hub is more than just your address book. It's also where you can keep up with your social networks and stay in touch with the people you care about most.

1. On the Start screen, tap the **People** tile.
2. Slide left and right across the screen to access your contacts list and see what's happening with your contacts.

all	Your contacts list. Just tap a contact to call, text, chat, or view that person's updates and pictures. Tap a group to send a group message and see updates and pictures from the group members
what's new	Here's where you can check out your contacts' latest updates, all handily rolled together from your various social network accounts.
recent	Here you'll see and get quick access to the contacts you've viewed or communicated with most recently.
together	Here's where you can create private Rooms to chat and share photos, videos, calendars, and more. You can also create Groups to make it easier to follow your friends' status updates, send group text messages, and more.

Importing contacts from your SIM card

When you import contacts from your SIM card, they're automatically synced to your Microsoft account. They won't be deleted from the SIM card. If you haven't set up a Microsoft account, your contacts are saved to your phone.

1. On the Start screen, tap the **People** tile.
2. Tap **⋮** > **settings** > **import SIM contacts**.

Adding a new contact

1. On the Start screen, tap the **People** tile.
2. In the **all** contacts list, tap **+**.
3. If you have more than one account set up on your phone, tap the account you want to create the contact in.

4. Tap each item (such as **name**, **phone**, **email**) and then enter the information.
After entering information for each item, make sure to tap  to save it.
5. Tap **add photo** to assign a picture or use the camera to take a picture of your contact.
6. When you're done, tap  to save the new contact.

Jumping to a section in the contacts list

1. In the **all** contacts list, tap a letter tile to display all the alphabet tiles.
2. Tap a letter to quickly jump to the section that has contact names beginning with that letter.

Filtering your contacts list

You can filter the list to show contacts only from the accounts you choose.

1. In People, tap **•••** > **settings**.
2. Tap **filter my contact list**.
3. Select the accounts from which you want to show contacts, and then tap .

Merging contact profiles

In People, you might have two or more versions of the same contact. This is usually because you have the contact's profile on different social network or email accounts. In most cases, your phone will combine contact profiles automatically. For those that are not combined, you can link them manually.

1. Tap a contact that has one or more duplicate entries in the **all** contacts list.
2. Tap .
3. You can:
 - Under **suggested links** (if available), tap the one that you want to link to the contact.
 - Tap **choose a contact** and then tap one that's a duplicate entry.

Unlinking contact profiles

1. In the **all** contacts list, tap the contact that has linked profiles.
2. Tap the link icon that shows the number of links .
3. Under **linked profiles**, tap the one that you want to unlink.
4. Tap **unlink**.

Searching, editing or deleting

Searching for a contact

If your contacts list is especially long, search is probably the quickest way to find a contact.

1. In the **all** contacts list, tap .
2. In the search bar, enter the first few letters of the first or last name of the contact you're looking for.
Matching contacts are then displayed.
3. Tap the contact to view the person's contact information.

Editing a contact's information



Contacts from Facebook®, Twitter™, or LinkedIn® cannot be edited. But you can add information, and then save it to a different account (such as your Microsoft account).

1. In the **all** contacts list, tap the contact whose information you want to change.
2. Tap .
3. If this is a linked contact (someone with multiple accounts that show up as one entry in your contacts list), tap the account you want to edit (for example, tap **edit Microsoft account**).
4. Edit or add new information for the contact.
After entering new information for an item, remember to tap  to apply the changes.
5. When you're done, press  or .

Deleting a contact



While you can't delete a Facebook, Twitter, or LinkedIn contact on your phone, you can delete contacts from other services. When you do this, the contact will be deleted both from your phone and from the online service where it's stored.

1. In the **all** contacts list, tap the contact you want to delete.
2. Tap **⋮ > delete**.
3. If the contact is a linked contact (someone with multiple accounts), choose which account to remove the contact from.



You can also press and hold a contact and then tap **delete**.

Sharing with a group of contacts in real-time

Rooms are places where you can have a group chat and share photos, videos, calendars, and more.

Creating a new room



Only contacts with Windows Phone 8 can participate in a room. When you create a room, you are the owner of the room. All other room members are guests.

1. On the Start screen, tap the **People** tile.
2. On the **together** screen, tap > **Room**.
3. Enter a name for the room and tap .
4. Tap and then choose a contact to invite to the room.
Repeat this to invite more contacts to the room.



Invites to the room are sent by text message.

5. When you're done, tap .

Inviting contacts to a room

1. Tap the room you want to invite contacts to.



You can't invite people unless you are the owner of the room.

2. Tap > .
3. Tap the contact you want to invite.
4. To invite another contact, tap .
5. When you're done, tap .

The person you invited will receive a text message with a link to join your room.

Rearranging room tiles

Mix things up a bit. You can rearrange the room member tiles any way you like.

1. Tap the room you want to change.
2. Press and hold a contact until the tile floats.
3. Drag the tile to a new location.
4. When you're done, press .

Managing a room



You can only manage a room you created.

1. Tap the room you want to manage.
2. Tap **⋮**.
3. You can:
 - Change the name of the room.
 - Add or remove guests.
 - Delete the room.

Leaving a room

1. Tap the room you want to leave.



You can't leave a room if you are the owner.

2. Tap **⋮** > **leave room** > **leave**.

Organizing your contacts into groups

Groups help you to filter your social networks. Groups also make it easier to send out the same email and text message to more than one contact. When you create a group, it shows up on the **together** screen.

Tap a group and you'll see the group members and their social networking updates, along with options for group email, texting, and chat.

Creating a new group

1. On the Start screen, tap the **People** tile.
2. On the **together** screen, tap **⊕** > **Group**.
3. Enter a group name and tap **⊞**.
4. Tap **⊕** and then choose a contact to add to the group.

Repeat to add more contacts to the group.



Press and hold a group to pin it to the Start screen.

Adding contacts to a group

1. Tap the group you want to add contacts to.
2. Tap  > .
3. Tap the contact you want to add.

Removing a contact from a group

1. Tap the group you want to remove a contact from.
2. Tap  and select the contact you want to remove.
3. Tap **remove from group**.

Changing a member's contact preference

If a contact has more than one email address or phone number, you can select the email address or phone number to use when sending a group email or text message.

1. Tap the group with the member whose contact preference you want to change.
2. Tap  and then tap the contact.
3. Tap the **Phone number** box or **Email address** box to change the information.
4. When you're done, tap .
5. Tap  to return to the group screen.

Rearranging group tiles

Don't want to view group members in alphabetical order? You can arrange the group member tiles any way you like.

1. Tap the group you want to change.
2. Press and hold a contact until the tile floats.
3. Drag the tile to a new location.
4. When you're done, press .

Renaming a group

1. Tap the group you want to rename.
2. Tap  > **rename**.
3. Enter a new name for the group.
4. When you're done, tap .

Deleting a group

1. Tap the group you want to delete.
2. Tap  > **delete**.

What is the Me tile?

The Me tile is a shortcut to your profile. You can access your profile either from the **Start** screen or the People hub. It's your one-stop shop for social networking.

- On the Start screen, tap the **Me** tile.
- On the Start screen, tap the **People** tile. Tap your profile picture.

Here are some things you can do:

- Post a new message on your social networks.
- See and comment on social network posts.
- Like social network posts.
- Reply to or retweet updates on Twitter.
- Update your profile picture on Facebook.
- Update your profile picture on your Microsoft account.
- Set your chat status. Let other people see when you're available on instant messaging.

Posting to social networks

You can post messages to your social networks and comment or like other people's posts. You can also check in to share your location with friends.

Go to **Settings > email + accounts** to check what types of social network accounts can be set up on your phone.

Posting a message

1. On the Start screen, tap the **Me** tile.
2. Tap **post an update** and then type your message.
3. If you have more than one social network account, tap the **Post to** text box, choose which accounts to post to, and then tap .
4. Tap .

Commenting on a post

1. On the Start screen, tap the **People** tile.
2. Slide left or right to go to **what's new** so you can see recent posts from your contacts.

3. When you see a post you want to comment on or like, tap .
4. Tap the box that says add a comment, type your comment, and then tap .



To like a post, tap  (or tap  to unlike).

Checking in

When you check in to a place, you share your location with your contacts by posting it on one or more of your social networks. You can find nearby locations, or you can add one yourself.

1. On the Start screen, tap the **Me** tile.
2. Tap **check in**.
3. Do one of the following:
 - Tap a place in the list to check in from there.
 - If you don't see your location listed, tap  to make the app find your location. Type the name of the place where you're at, and then tap .
 - To search for a nearby place, tap , type the name of the place, and then tap .
4. Once you've found the place you want to check in from, tap the **Post to** box to choose the account you want to use to check in.
5. Tap the **Share on Facebook with** box to set your Facebook privacy level.
6. Tap  to check in.

Filtering social updates

Flooded with updates? Try viewing posts from one social network at a time. Or you can hide the updates from one or more of your social networks.

- In People, slide left or right to go to **what's new**. Tap **all accounts**, and then tap the account you want to view posts from.
- Or tap **...** > **settings**, and then select **Hide posts from the contacts I've filtered**.

Posts from the social networks you've filtered out of your contacts list will no longer be visible.



You can also create a group to only see updates from contacts in that group.

Keyboard

Using the onscreen keyboard

When you start an app or select a field that requires text or numbers, the onscreen keyboard becomes available.

Tap anywhere onscreen where you can type and the keyboard appears automatically.



After you've finished using the keyboard, press  to close it.

Turning caps lock on

Press and hold or double-tap the shift key . Tap it again to turn caps lock off.

Entering numbers and symbols

1. Tap  to switch to the numeric and symbol keyboard. You'll find numbers, common punctuation marks, and symbols on the keyboard.
2. To use more symbols, tap .
3. Some of the symbol keys can bring up even more symbols. Press and hold a symbol to see more.

For example:

- Press and hold a symbol key such as the left parenthesis key, and then tap the symbol that you want.



- Press and hold the period key to bring up some of the common punctuation options, and then tap the one that you want.
- Press and hold the \$ key to see more options for currency symbols, and then tap another currency symbol.

Moving the cursor

To place the cursor in the middle of the text you've already entered, press and hold near the text you want to change until a cursor appears, and then drag your finger to move the cursor exactly where you want it.

Entering words with predictive text

The onscreen keyboard has predictive text to help you type quickly and accurately. Predictive text input is enabled by default, and word suggestions are displayed as you type.

To enter a word in predictive mode:

- If you see the word you want highlighted in bold, just tap the space bar to insert the word into your text.
- If you see the word you want shown in the suggestions before you have finished typing the entire word, tap the word to insert it into your text.
- Slide across the suggestion bar to see more words.
- If you mistyped something or chose the wrong word, just tap that word to display the suggestion bar and choose the right word.

Changing the keyboard language

You can choose between a variety of languages, layouts, and regions for your keyboard. Your phone can provide word suggestions and spelling corrections based on the language you choose.

1. On the Start screen, slide to the left.
2. Tap **Settings** > **keyboard**.
3. Tap **add keyboards**.
4. Select the languages you'd like to be able to use from the onscreen keyboard. The next time you use the keyboard, you'll see the language key .



The language key will look different depending on the keyboard.

5. When you're done, tap .
6. While using the onscreen keyboard, tap the language key  to switch between the languages you've selected.



You can also press and hold the language key to see all of the available keyboard choices.

Messaging

Texting and chatting in one place

With the Messaging app, you can both text and chat in one place.



Whether your friends and family are on their mobile phone or at their computer, you can send them text messages or Microsoft Messenger instant messages.

You can also start a Facebook chat.



- To chat on Messenger, you need to set up your Microsoft account first.
- To chat over Facebook, you need to set up your Facebook account. Also, make sure to turn on Facebook chat in the Messaging app's settings.

1. On the Start screen, tap .
2. If you want to send an instant message over Microsoft Messenger, set your chat status first, if you haven't done so.
3. Tap .
4. Tap , choose a contact, and then tap the contact's phone number or Messenger ID to determine how you want to send the message.

You can also send a message to a Facebook contact.

Repeat to add more recipients, and their names will be added automatically in the **To** box.

5. Tap the box that says *type a message*, and then enter your text.
6. Tap  to send it.

When adding recipients, you can also:

- Tap , and then select a contact group. The **Group text** option in the app's settings is turned on by default and can help keep replies in one thread when you're texting with a group of people. When it's turned on, replies are sent as multimedia messages instead of text messages.
- Begin typing a person's name in the **To** box, and then tap a matching contact name.
- Enter a mobile phone number or email address in the **To** box. To enter additional recipients, tap Enter after each one.

Setting your chat status

1. On the Start screen, tap .
2. Tap , and then tap a status.

For example, tap **available** to sign in so that your family and friends will see you online in their Microsoft Messenger.



You can also set your chat status by tapping the Me tile on the Start screen.

After you set your chat status and sign in, you'll see who's online in the Messaging app. Tap a contact to send the person an instant message.

Sharing pictures, videos, and more in a message

You can send a multimedia message by attaching a picture, a video, and more to a text message. You can also add attachments to an instant message on Microsoft Messenger.

You can also send a picture to a Facebook contact.



Before sending multimedia messages, make sure that this service is included on your data plan.

1. On the Start screen, tap .
2. Tap  to create a new message.
3. In the **To** box, fill in the recipient's name, mobile phone number, or email address.

4. Tap  to do the following:

Attach a picture	Tap picture , and then choose an existing photo or tap  to take a photo and attach it. The picture is automatically resized when you attach it to a text message.
Attach a video	Tap video , and then choose an existing video.
Attach your location	Tap my location .
Attach a voice note	Tap voice note , and then start speaking. Tap done when you're finished recording.
Attach contact information	Tap contact , and tap a contact to share. Tap  to add the contact to your message.



To remove an attachment, press and hold the attachment and tap **remove**.

5. Enter your message using the onscreen keyboard or tap  to use voice recognition.
6. Tap  to send.

Viewing and replying to a message

When you receive a new message, you'll hear a notification sound (if set) and see the message briefly display at the top of the screen.



1. To open and read the message, you can:
- Tap the notification at the top of the screen.
 - Or open the Messaging app to access and read the message.
2. Enter your reply, and then tap .



If the contact has more than one phone number or email address, you can tap  to choose another one.

Why can't I reply to my friend using Facebook or Messenger on the same thread?

If you're friends with someone on Facebook or Messenger, you may have several different contact profiles for the same person. Their phone number, Facebook, and Messenger info may be stored as different contacts on your phone. In this case, you need to link these contacts manually.

Open the People app and link them.

Copying and pasting a message

You can copy a previous message and paste it into the new message you're composing.

1. In the **threads** list, tap a contact (or phone number) to display the exchange of messages with that contact.
2. Press and hold the message you want to copy, and then tap **copy**.
3. Tap the text box where you're composing your new message.
4. To paste the copied message, tap .

Managing conversations

Forwarding a message

1. In the **threads** list, tap a contact (or phone number) to display the exchange of messages with that contact.
2. Press and hold the message you want to forward, and then tap **forward**.
3. Fill in the recipient.
4. Tap  to send.

Deleting a message

1. In the **threads** list, tap a contact (or phone number) to display the exchange of messages with that contact.
2. Press and hold the message you want to delete, and then tap **delete**.

Deleting a whole conversation

In the **threads** list, press and hold a contact (or phone number) whose messages you want to delete, and then tap **delete**.

Email

Adding your Microsoft account

When you first set up your phone, you're asked to sign in with your Microsoft account. If you didn't sign in then or if you have more than one Microsoft account, go to the settings to set up your primary Microsoft account or additional accounts.

1. On the Start screen, slide to the left.
2. Tap **Settings** > **email+accounts**.
3. Tap **add an account** > **Microsoft account**.
4. Enter your Microsoft account and password, and then tap **sign in**.

Your Microsoft account email, contacts, calendar, photos, and feeds will be synced to your phone.



- The first Microsoft account that you set up can't be deleted from your phone.
- If you set up additional Microsoft accounts, photos from these accounts won't be synced to your phone.

Adding a POP3/IMAP email account

1. On the Start screen, slide to the left.
2. Tap **Settings** > **email+accounts**.
3. Tap **add an account**.
4. Choose the type of email account that you want.
If you don't see it in the account list, tap **other account**.
5. Enter your email address and password, and then tap **sign in**.

Your phone then looks for your account settings, completes the setup, and syncs information from your account.

If what you've set up is your Google® Account, your phone will sync and download your Gmail™ as well as your Google contacts and calendar from your account.

If you've set up other POP3 or IMAP accounts, your phone will sync email from those accounts.



If your phone can't find your account settings, go to the advanced setup to enter the incoming and outgoing server and other settings manually. You'll need to get these information from your email provider.

Adding a Microsoft Exchange ActiveSync account

1. On the Start screen, slide to the left.
2. Tap **Settings** > **email+accounts**.
3. Tap **add an account**.
4. Tap **Outlook**.
5. Enter your email address and password, and then tap **sign in**.

If your account settings are found, wait for your phone to finish syncing with your work email, contacts, and calendar.



If your account settings can't be found, follow the onscreen instructions to enter your Exchange ActiveSync account settings manually. Ask your Exchange Server administrator for these settings.

Checking email

After you've set up your email accounts, a new tile for each account will be added to the Start screen.

1. To open an email account, tap its tile on the Start screen.



If you don't see the tile, slide left from the Start screen, and then tap your email account in the apps list.

2. In the **all** email list, scroll up or down to skim through your email messages.

Email messages are neatly grouped into conversations. If there were back and forth replies to an email, tapping that email expands and shows its series of messages.

3. Tap an email message to open and read it.



If you have a long email list, you can also slide left or right to skim through unread, flagged, or urgent email only.

Replying or forwarding email

1. Open and read the email message.
2. Tap .
3. Choose whether to reply only to the sender, reply to all, or forward the email.

Linking inboxes as one

To check your email from all your accounts just in one place without having to switch to different accounts, you can link your inboxes as one.

1. Tap **•••** > **link inboxes**.
2. Under **other inboxes**, tap one or more email accounts that you want to combine to your unified inbox.

The default name for your unified inbox is **Linked inbox**.



Tap **rename linked inbox** if you want to change the name of your unified inbox.

3. Press **←** to return to your inbox. You'll now see just one inbox containing all your email from your different accounts.

Next time you want to check your email, tap  on the Start screen or in the apps list.

Unlinking an inbox

1. Tap **•••** > **linked inboxes**.
2. Under **this inbox**, tap the email account you want to remove from the unified inbox.
3. Tap **unlink**.

Sending email

1. Open the email account that you want to use for sending your email.
2. Tap .
3. Fill in one or more recipients. In the **To** field, you can:
 - Tap  to choose a contact. Tap it again to add more.
 - Start typing a person's name or email address. If there are matches found from your stored contacts as you type, they will be listed. Tap the one that you want.
4. Enter the subject and compose your message.

5. To attach a picture, tap .
6. When you're ready to send your email, tap .



- When entering several email addresses manually, separate them with a semicolon.
- To send a carbon copy (cc) or blind carbon copy (bcc), tap **⋮** > **show cc & bcc** and add other recipients.

Setting the priority for an email message

You can set the priority for an email message before sending it.

1. While composing the message, tap **⋮** > **priority**.
2. Select the priority for the message.

Saving or discarding the email

1. While composing your email, tap .
2. Choose whether to save your email as a draft or delete it.

Resuming an email draft

1. While in the email list, tap **⋮** > **folders** > **drafts**.
2. Tap the draft email to edit it.
3. Send the email.

Managing email messages

Deleting, moving, flagging, or marking several email messages

1. Tap .
2. To quickly select all email messages in a conversation, select the top one (the one that shows the subject and number of messages).
Or to select individual email messages, tap their respective check boxes.
3. Choose what you want to do with the selected messages.
 - Tap  to delete.
 - Tap  to move them to another mail folder.
 - Tap **⋮** and choose whether to flag or mark the messages as read or unread.



You can also just tap on the far left of an email to select the email first. Check boxes will then appear and you can select more email messages.

Deleting, moving, flagging, or marking one email

1. Press and hold a conversation or a single message.
2. On the options menu, choose what you want to do with the whole conversation or the single message.

Switching to another mail folder

1. Tap **⋮** > **folders**.
2. Tap **show all folders** to see all the available mail folders.
3. Tap the mail folder whose email messages you want to view.

Changing email account settings

1. On the Start screen, tap the email account that you want.
2. Tap **⋮** > **settings**.
3. Tap **sync settings** to choose how often to download items or change the items that you want to sync.
4. Choose if you want a signature to appear in your sent email.
5. Tap **✓**.

Photos, videos, and music

Photos

About the Photos hub

On the Photos hub, you can view the photos and videos you captured with the camera, flip through online albums, or catch up with your friends' latest snapshots.

1. On the Start screen, slide to the left.
2. Tap Photos.
3. Slide left or right across the screen and you'll see the following:

picture collection	You can view your pictures and videos by album or date, or see what's on the camera roll. You can also check out your friends' online albums or your own.
favorites	See up to 8 pictures you've tagged as favorites, or tap see all to view the rest. You can even pin your favorites to the Start screen for one-tap access.
what's new	Here you'll find the latest pictures your friends have uploaded on social networking sites. Tap one to post a comment or tag a friend.
apps	Here you'll find Photo Enhancer and other apps that you can use to edit your photos.

Adding a photo to your favorites

Some snapshots are so great you just can't get enough of them. To get to these photos quicker, add them to your favorites.

1. On the Photos hub, find a photo you like and tap to open it.
2. Press and hold the photo, and then tap **add to favorites**.



Before you can add a photo from an online album to your favorites, you first need to save it to your phone. Open the photo, and then tap **•••** > **save to phone**.

Changing the background on the Photos hub

You can pick out any photo to use as the background on your Photos Hub — even photos from online albums. Better yet, your Photos hub can also show a rotating selection of your favorite pictures.

1. On the Start screen, slide to the left.
2. Tap **Photos**.
3. Tap **⋮**.
4. You can:
 - Choose a photo to use as the background. Tap **choose background**, select a photo, and crop it.
 - Tap **shuffle background** to just shuffle photos that are tagged as favorites.



If you have the Photos tile on your Start screen, the background you choose will also show up in the tile.

Sharing

Share photos or videos with your friends and loved ones. You can send photos and videos in a multimedia message or email. You can also upload photos or videos to your online accounts.



Make sure you've signed in to your online accounts before uploading.

1. On the Photos hub, find and open the photo or video you want to share.
2. Do one of the following:

Share to a social network	<ol style="list-style-type: none"> 1. Tap ⋮ > share. 2. Choose how to send it or where you want to share it.
Share to SkyDrive	<ol style="list-style-type: none"> 1. Tap ⋮ > save to SkyDrive. 2. Tap  or  to save your picture or video to SkyDrive. You can then attach the picture or video to any email, multimedia message, or status update in the future.

Using Photo Enhancer

Photos need a bit of touch-up? Improve photos taken in poor lighting conditions with one tap. Or apply special effects to give your photos a unique touch.

1. On the Start screen, slide to the left.
2. Tap **Photo Enhancer**.
3. Tap **choose picture**.

4. Open the album where the photo you want to edit is located, and then tap the photo.
5. To see what's available, slide left or right across the thumbnails of the various effects.
6. Tap an effect to apply it to your photo.
7. Tap  to save.

The enhanced photo will be saved in another album called **Saved Pictures**.

Music + Videos

Playing music, videos, and podcasts

Listen to music, catch up on your favorite podcasts on your commute, or enjoy a movie on your next flight.

1. On the Start screen, slide to the left.
2. Tap **Music+Videos**.
3. Under **collection**, tap **music**, **videos**, or **podcasts**.
4. Slide left or right to different categories (such as artists or albums when browsing through music).
5. Tap the item that you want to play. The playback screen opens and starts to play the music, video, or podcast.
6. Use the onscreen controls to control the playback.

Making your music sound better

When you plug in your headset, Beats Audio is automatically enabled to give you an enhanced sound experience.

1. To turn Beats Audio on or off, slide left from the **Start** screen, and then tap **Settings > Beats Audio**.
2. Tap the on/off switch to turn Beats Audio on or off.

Sync and Backup

Keeping things in sync

It's easy to get your photos, videos, music, documents, and more from your computer to your phone (and vice versa).

If you have a...	Do this...
Windows 8 PC	Plug your phone into your computer with the cable, and the Windows Phone app will install automatically.
Windows 7 PC	Plug your phone into your computer with the cable. A link will appear to install the Windows Phone app.
Mac®	Get the Windows Phone app from the Mac App Store.

To learn more about finding the right app, go to WindowsPhone.com.

Backing up your files

When you sign in with your Microsoft account, you'll be able to save things to an online service such as SkyDrive.

When you set up backups on your phone, you can:

- Automatically upload your photos and videos to SkyDrive so you can see them from anywhere you can access the web.
- Sync your SMS and MMS messages to Hotmail® so you have a backup, just in case.
- Create backups of your phone's settings, including the list of apps you've installed, your theme color, Internet Explorer® favorites, accounts, and more.

You can fine-tune your backup options in **Settings > backup**. For example, you can automatically upload your photos and videos at a high resolution, or manually back up your settings anytime.

Internet connections

Data connection

When you turn on your phone for the first time, it will be automatically set up to use your mobile operator's data connection (if the SIM card is inserted).

Turning the data connection on or off

Turning your data connection off can help save battery life and save money on data charges. However, if you don't have data connection turned on and you're also not connected to a Wi-Fi network, you won't receive automatic updates to your email, social network accounts, and other synchronized information.

1. On the Start screen, slide to the left.
2. Tap **Settings** > **mobile networks**.
3. Tap the **Data connection On/Off** switch.

Using Connection Setup

The Connection Setup app makes it quick and easy to reconfigure your data connection settings.

When you change to another SIM card and restart your phone, Connection Setup opens and sets up your phone's data connection automatically based on your new SIM card.

If your mobile operator uses different profiles of connection settings for their data services (for example, different settings for Internet and WAP), you can also use this app to easily switch between their profiles.

Switching to another data connection

Manually choose a mobile operator in Connection Setup if the app did not auto-configure your phone's data connection, or if you need to switch to another mobile operator so you can use a certain data service.

1. On the Start screen, slide to the left.
2. Tap **Connection Setup**.
3. Tap **•••** > **manual select**.
4. Select the country, and then mobile operator to use.
5. Tap  to apply the changes.

Adding a new access point

An access point name (APN) is the address your phone uses to connect to the data network. By default, APNs are set automatically when your phone is first set up. If your cellular data connection isn't working or you can't send a multimedia message (MMS), try entering a new APN based on your location and mobile operator.



Before adding, have the access point name and settings (including username and password if required) from your mobile operator ready.

1. On the Start screen, slide to the left.
2. Tap **Settings** > **mobile networks**.
3. Tap **add internet apn** or **add mms apn**.
4. Enter the APN and other required settings.
5. Tap  to save.

Enabling data roaming

Connect to your mobile operator's partner networks and access data services even when you're out of your mobile operator's coverage area.



Using data services while roaming will be costly. Check with your mobile operator for data roaming rates before you enable data roaming.

1. On the Start screen, slide to the left.
2. Tap **Settings** > **mobile networks**.
3. Tap the **Data roaming options** box, and then tap **roam**.

Wi-Fi

To use Wi-Fi, you need access to a wireless access point or "hotspot". The availability and strength of the Wi-Fi signal will vary depending on objects, such as buildings or simply a wall between rooms, the Wi-Fi signal has to pass through.

Connecting to a Wi-Fi network

1. On the Start screen, slide to the left.
2. Tap **Settings** > **Wi-Fi**.

3. Tap the **Wi-Fi networking On/Off** switch to turn Wi-Fi on.
You'll then see a list of available wireless networks.
4. Tap the wireless network you want to connect to.
 - If you selected an open network, your phone will automatically connect to the network. (Some Wi-Fi networks, such as ones you might find in coffee shops, restaurants, hotels, or elsewhere, may require you to enter a password in your web browser before you can connect.)
 - If you selected a secured network, enter the required password and then tap **done**.

When you're connected to a wireless network, the Wi-Fi connected icon  appears in the status bar and shows you the signal strength (indicated by the number of bands that light up).

The next time you connect to the same secured wireless network, you won't be asked to enter the password or other security information again, unless you do a factory reset.

Connecting to a hidden Wi-Fi network

A Wi-Fi network might be hidden, which means the network name isn't broadcasted. In this case, it won't appear in the list of available networks on the **Wi-Fi Settings** screen and a notification won't appear when the network is in range. To connect to a hidden Wi-Fi network when it's in range, you'll need to enter the network name and password.



The network name and password are case sensitive.

1. On the Start screen, slide to the left.
2. Tap **Settings > Wi-Fi**.
3. Make sure that Wi-Fi is turned on.
4. Tap **advanced**.
5. Tap , enter the network name, and then tap **add**.
6. On the **Sign in** screen, enter the password, and then tap **done**.

Disconnecting from a Wi-Fi network

1. On the Start screen, slide to the left.
2. Tap **Settings > Wi-Fi**.
3. Tap the **Wi-Fi networking On/Off** switch to turn Wi-Fi off and disconnect from the wireless network.

You can also press and hold the network name and then tap **delete** to disconnect. But this removes the security settings if it's a secured network, and you'll need to enter them again next time you reconnect to this Wi-Fi network.

Using your phone as a mobile hotspot

Want to share your Internet connection with your laptop or another device? You can turn your phone into a mobile hotspot by sharing your cellular data connection over Wi-Fi. Other Wi-Fi enabled devices can then use your shared data connection to connect to the Internet.



- To share your cellular data connection, this feature must be enabled on your current phone plan. This is also known as tethering and often costs extra.
- When you and other people use the shared connection on another device, it uses data from your cellular data plan.

1. On the Start screen, slide to the left.
2. Tap **Settings > internet sharing**.
3. Tap the **Sharing On/Off** switch to turn Internet Sharing on.
4. Tap **setup**, and then change these settings:

Broadcast name	Enter a name for your mobile hotspot. This is the name that other people will see and use to connect to your shared connection over Wi-Fi.
Password	Enter a password to secure your mobile hotspot.

5. Tap  to save your settings.

When you tap the top of the screen to see the status bar, you'll see the Internet Sharing icon  while you're sharing your cellular data connection.

Search and Web browser

Ways you can search the Web

Just press  to search the Web using Bing®.

Besides typing what you want to search, you can do much more with Bing:

- Search the Web by voice. To find out more, see [Using speech on your phone](#) on page 24.
- Use Bing Vision to scan QR codes, text, and images such as book covers, and then find these on the Web. See [Scanning codes, tags, and text](#) on page 62.
- Use Bing Music to find details about the music you're listening to. To find out how, see [Music search](#) on page 65.
- Look for nearby restaurants, shops, and things to do. See [About Local Scout](#) on page 69.



Some web search features may not be available in certain countries.

Searching for information

1. Press . The Bing Search screen opens.
2. Tap the search box, enter what you want to search for, and then tap  on the keyboard.
3. Slide left or right across the screen to narrow or broaden the search results to **web**, **local**, **media**, or **shopping**.





Under the **web** results, you can scroll up or down to see different kinds of results, such as news, related searches, apps, products, flight status, and more. The types of results displayed will depend on what you've entered and searched for.

Scanning codes, tags, and text

Want to scan and search for something? Using Bing Vision, you can use the camera to scan lots of things you see, and then search for those things on the Web.

You can scan QR Codes and Microsoft Tags that you see in magazines, online, on signs, or anywhere else. You can also scan text to search, have it translated, and paste scanned text into a message.



The items you can scan and search for vary by country or region.

Scanning a QR Code

1. Press .
2. On the Bing Search screen, tap .
3. Point the camera at the QR Code you want to scan.
You'll then see the Results screen.
4. Tap the result to get info about the QR Code. The information that appears depends on the QR Code and can be a message, contact info, email address, website, or phone number.

Scanning a Microsoft Tag

1. Press .
2. On the Bing Search screen, tap .
3. Point the camera at the Microsoft Tag you want to scan.
You'll then see the Results screen.
4. Tap the result to get info about the Tag.

Searching by scanning a barcode, book, CD, or DVD cover

1. Press .
2. On the Bing Search screen, tap .
3. Point the camera at the barcode, book cover, CD cover, or DVD cover you want to scan.
You'll then see the Results screen.
4. Tap the result to get info from the Web about the item you've just scanned.

Searching by scanning text

You can scan text and then search the Web using the scanned words. Or you can have the text translated.

1. Press .
2. On the Bing Search screen, tap .
3. Point the camera at the text you want to scan, and then tap **scan text**.
4. You can:

Search the Web.	Tap each of the squares that contain the words you want to search for, and then tap search .
See a translation for text that's recognized.	Tap translate , and then choose a language.

Copying and pasting scanned text

1. Press .
2. On the Bing Search screen, tap .
3. Point the camera at the text to scan, and then tap **scan text**.
4. Tap **...** > **copy all**.
5. Open the file, app, or message where you want to paste the text.
6. Tap where you want to paste the text.
7. In the text suggestion bar above the keyboard, tap the paste icon .

Selecting from previous image search results

1. Press .
2. On the Bing Search screen, tap .
3. Tap **history**.
4. On the Vision history screen, tap a past result.

Opening and navigating web pages

Internet Explorer Mobile makes it quick and easy to surf the Web on the go. By using tabs, you can open multiple web pages and switch between them quite easily.

Opening a web page

1. On the Start screen, tap .
2. Tap the address bar, and then enter a web address. As you type, Internet Explorer will suggest possible matches.
3. If you see the site you're looking for, tap it. Or tap  on the onscreen keyboard.

Using tabs to open multiple web pages

You can open up to six separate browser windows (called "tabs" in Internet Explorer) simultaneously. Tabs make it easy to hop between sites.

1. In Internet Explorer, tap  > **tabs**.
2. Tap  to open a new tab. A blank browser screen then opens.
3. On the new browser screen, go to a website that you want.

Switching between tabs

1. In Internet Explorer, tap  > **tabs**.
2. Tap the thumbnail that shows the website you want to open.

If you no longer need to view a website, you can close the tab by tapping .

Sharing a link

When you see a website that you like, you can easily tell your friends about it by sharing its link. You can send the link in your text or email message. Or post it in your social networks.

1. While viewing the website in Internet Explorer, tap  > **share page**.
2. Choose how you want to share the link.

If you chose to share the link in your social networks, enter your message, select which networks to post on, and then tap .

Music search

Songs you hear on the radio, or when you're out and about, don't need to be a mystery anymore. You can search for music that's playing to find out more about it, such as the song title, artist, album, and ways to listen to or buy it.



- Bing Music can only recognize recorded music. Music from live performances or humming can't be recognized.
- Bing Music may not be available in some countries or regions.

Searching for recorded music that's playing

1. Press . The Bing Search screen opens.
2. With the music playing, hold your phone where you can clearly hear the music, and then tap .

After scanning, the song title, artist, album name, and album art will appear for songs that are recognized.

3. To find the song in Store, tap **Store**. You can then preview that song and other ones on the album, and also buy if you want to.

Selecting from previous music search results

You can go back and find music that you've searched for in the past.

1. Press .
2. On the Bing Search screen, tap **•••** > **music history**.
3. On the **Music history** screen, tap a song to find it on Store.

Maps and location

Location services

Turning on location services

You can choose to turn on location services to allow apps to use your location information and provide you with a richer experience. For example, your GPS location can be stored on the photos that you take with the Camera app. You can also use Maps to display your location.

1. On the Start screen, slide to the left.
2. Tap **Settings > location**.
3. Tap the Location services **On/Off** switch.

Apps for which you enable location services can now access your current location.

Maps

About Maps

Maps can show you where you are, find the address or place you're looking for, and give you directions to reach your destination. It can also show you nearby stores or restaurants you might be interested in and what other people are saying about them.



- You need to connect to the Internet to use Maps.
- Certain features of Maps may not be available in some countries or regions.

Moving around the map

1. Drag your finger in any direction to view other areas of the map.
2. To zoom in, spread your thumb and forefinger apart on the map. To zoom out, pinch your fingers together.
3. Double-tap the map to automatically center and zoom in on a spot. Double-tap again to get even closer.

Finding your location



Before you can find your location and see it on the map, you need to turn on location services in the settings first (if you declined when the Maps app asked to access and use your location).

1. On the Start screen, slide to the left.
2. Tap Maps. The app tries to find your location and displays it on the map.
3. If the displayed location on the map isn't quite accurate, tap  to find your location again.

Finding an address or place

1. On the Start screen, slide to the left.
2. Tap Maps.
3. Tap .
4. In the search box, enter any of the following:
 - An address
 - A zip or postal code
 - A city
 - A business name or type
 - An intersection
 - A point of interest
5. Tap  on the onscreen keyboard.
6. To get more info about the place, tap the pushpin  on the map.



You may see several pushpins on the map if there are several results found.

What are pushpins?

Pushpins are handy for remembering places you want to visit, getting directions, or sharing location info. They're automatically shown on the map when you search for places. You can also manually add a pushpin.

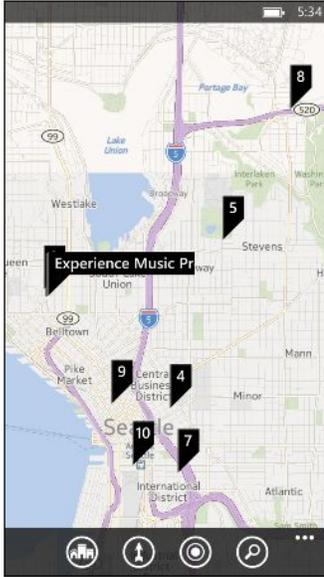

When you tap a pushpin **1** for a store, restaurant, or other point of interest, the **about** screen opens and displays additional info, such as the street address, directions, phone number, hours, web address, and customer reviews. You can choose what to do with the location info, such as pin to your Start screen, add to your favorites, or share it.

Adding a pushpin

While viewing your map, press and hold on the spot where you'd like to add a pushpin.

Viewing pushpins as a list

If several pushpins are shown on the map after you've done a search, you can display them as a list to see the search results in detail.

While viewing the map, tap **•••** > **search results**.

Sharing an address

Need to tell someone where to meet you? Send the address in a text or email message, so the person you're meeting with can see it on a map or get directions.

1. In Maps, search for the location you want to share.
2. Tap the pushpin of that location.
3. On the **about** screen, tap .
4. Choose how you want to share the address.

Getting directions

Get detailed directions to your destination. When viewing directions in Maps, you'll see the total distance and estimated travel time to help you plan ahead.



Certain features may not be available in some countries or regions.

1. While viewing a map, tap .
2. Use your current location as the starting point, or enter another location in the **Start** field. Enter your destination in the **End** field.
You can enter:
 - an address
 - a restaurant, store, or other business name
3. Tap on the onscreen keyboard. Maps then displays a split screen, showing a map with the planned route on top and the list of directions at the bottom. When you scroll through the list of directions, the map auto refreshes to show the direction.
4. Tap or to switch between driving or walking directions.
5. When you reach your destination, tap it to display the location information.



While viewing directions, press to view the map in full screen so you can see the route and pan on the map. To see the list of directions again, tap > **directions list**.

Local Scout

About Local Scout

New to the area or just looking for something new to do? Local Scout can help you find nearby restaurants, shops, and things to do. You can get relevant info about the different places to help you decide where to go.



Local Scout may not be available in some countries or regions.

Finding places near your location

1. On the Start screen, tap .
Maps then finds your location and displays nearby places you can go to on the Local Scout screen.
2. Slide left or right across the screen to view the various suggested places that are listed under these categories: **eat + drink**, **see + do**, **shop**, and **for you**.

3. Tap a place to get more info.
4. While viewing the list of places (such as restaurants under **eat + drink**), tap the map at the top of the screen to see where these places are on the map.

Finding places in another location

You can use Local Scout to find places in your destination so you can plan what to do after you arrive.

1. On the Start screen, slide to the left.
2. Tap **Maps**.
3. Tap .
4. In the search box, enter a city name.
5. Tap  on the onscreen keyboard.
6. Tap .

Changing how Local Scout searches

By default, Local Scout narrows the search by distance from your current location or a location that you specified. If you're looking for restaurants or stores, you can set Local Scout to search by ranking or category.

1. In Local Scout, tap the sorting option below the category title.
2. Tap the **Sort by** box, and then select how you want Local Scout to sort places that correspond your search. For example, you can tap **rating** to sort restaurants or stores based on other people's recommendations.
3. You can also select or clear other options on the **Set Filters** screen to expand, narrow, or filter the Local Scout search.
4. Press  to see the new search results.

Calendar

What you can do in Calendar

Never miss an important date again. You can sync your existing calendars from your email accounts to your phone and see them in the Calendar app. You can also add new appointments, create your to-do list, and respond to invitations that people send you.

- After you've set up your email accounts, the calendars associated with your accounts will be synced to your phone.

If you haven't set up your email accounts, see [Email](#) on page 48 to find out how to add them to your phone.

When you create new appointments on your phone, they will be synced to the calendars in your accounts.

- If you've set up a Facebook account, you'll see your Facebook events in the Calendar app. You can only view and not create or edit Facebook events on your phone.

Creating a calendar appointment

When creating a new appointment, you can choose which account's calendar to add it to.

1. On the Start screen, tap the **Calendar** tile.
2. In **day** or **agenda** view, tap .
3. If you have more than one calendar, tap the **Calendar** box, and then select an account in which to add the appointment.
4. Enter the appointment details.
5. At the bottom of the screen, tap **more details** to set a reminder, appointment's occurrence, and more.
6. Tap  to save.

Quickly creating an appointment on a time slot

If you don't need too much detail on your appointment, you can quickly create an appointment by just selecting a time slot and typing a subject right on the calendar.

1. In the Calendar app, go to **day** view.
2. Tap a time slot, enter a subject, and then tap .

Later, you can just edit the appointment if you need to add more details or move it to another account's calendar.

Sending an invitation

You can use Calendar to schedule a meeting or an appointment and invite people to attend it. An invitation email will be sent to them from the account that you choose.



You can only invite contacts that are stored or synced on your phone.

1. In Calendar, create a new appointment.
2. Tap the **Calendar** field, and then choose the account to use for sending the invitation.
3. Add details, such as date and time, location, and more.
4. Tap **more details**, scroll down the screen, and then tap **add someone**.
5. Invite required and optional attendees by tapping **add someone** below each field.
6. When you're done, tap .

Creating a new to-do task

To-dos show up on your calendar, and they appear alongside your appointments.



You can only create to-dos in your Microsoft and Outlook (Exchange ActiveSync) accounts.

1. In the Calendar app, swipe left or right to go to the **to-do** list.
2. Tap .
3. If you have more than one account, choose the account in which to add your to-do task.
4. Fill in the details for your task, such as subject, due date, and more.

5. To set a reminder, turn **Reminder** on, and then choose a date and time.
6. Tap  to save.

If you've set a due date, you'll see your to-do task in that date's **agenda** view. You'll also see your to-do task in the **day** view of your set reminder date and time.

Displaying and syncing calendars

You can choose which calendars to show or hide in the Calendar app, and which ones to keep synchronized.

Showing or hiding calendars

1. In **day** or **agenda** view, tap **⋮** > **settings**.
2. Tap the on/off switch for each calendar that you want to show or hide.



The calendars are kept synchronized on your phone, whether or not you hide them.

Choosing which calendars are synced on your phone

You can choose which calendars to keep synchronized on your phone.

1. On the Start screen, slide to the left.
2. Tap **Settings** > **email+accounts**.
3. Tap the account whose calendar sync setting you want to change.
4. Select or clear the **Calendar** check box, depending on whether you'd like to sync or stop syncing the account's calendar.
5. Tap  to apply the changes.

More apps

What can I do in the HTC hub?

In the HTC hub, you can check weather forecasts, stock updates, and the latest news.

Checking weather

Shirt or sweater? Check the local weather in the HTC hub before you head out.

1. On the Start screen, slide to the left.
2. Tap HTC.

You'll see the weather in your current location as well as the weather in other cities around the world.



3. Tap your current location to open the weather info screen and see more detailed weather forecasts for your location. Or tap another city to check its weather forecasts.
4. On the weather screen, tap the icons at the bottom to view in full screen or check hourly weather.
5. To check weather forecasts for upcoming days, tap **24h**, and then tap **4d**.



- To refresh the weather info onscreen, tap **•••** > **refresh**.
- Not seeing the weather in your current location? Return to the Start screen and go to **Settings** > **location** to check whether **Location services** is turned on.

Adding a city

1. On the HTC hub weather screen, scroll down the list to check what cities have already been added.
2. Tap .
3. Enter the name of a city or country.
As you type, matching locations are shown.
4. Tap the city that you want to add.

Changing the order of cities

1. On the HTC hub weather screen, tap  > **edit**.
2. Press and hold  at the end of the item you want to move.
3. When the selected city is highlighted, drag it to where you want it to appear in the list.
4. Tap **done**.

Deleting cities

1. On the HTC hub weather screen, tap  > **edit**.
2. Tap each city you want to delete.
3. Tap **done** to delete them.

Changing the temperature scale and other settings

1. On the HTC hub weather screen, tap your location to open the weather info screen.
2. Tap  > **settings**.
3. Under **Temperature scale**, select **Fahrenheit** or **Celsius**.
4. Turn on or off weather sound effects and other options.
5. Press  to apply the new settings.

Keeping track of your stocks

Get the latest updates for the stock quotes and market indices that you follow in HTC.

1. On the Start screen, slide to the left.
2. Tap **HTC**.

3. Flick left to go to the stocks list.



4. If there's a long list, swipe your finger up or down to browse through the stocks that you're following.
5. Tap an item to see a stock's trade information and price chart for the current day.
6. Tap another period if you want to check the stock's past trade information. For example, tap **5D** to check the trade information for the past 5 days.

Want instant updates to just one stock quote or index?

Easy. Just pin the stock quote or index to your Start screen.

1. On the Start screen, slide to the left.
2. Tap HTC.
3. Flick left to go to **stocks**.
4. Press and hold a stock quote or index that you want to place on your Start screen, and then tap **pin to start**.

A live tile for your chosen stock quote or index will be added to your Start screen.



Adding a stock quote or stock market index

1. While viewing stocks, tap .
2. Enter a stock quote or market index that you want, and then tap . Matched results will be listed.
3. Tap the stock quote or market index you want to add.

Changing the stock list order

1. While viewing stocks, tap  > **edit**.
2. Press and hold  at the end of the item you want to move.
3. When the selected item is highlighted, drag it to where you want it to appear in the list.
4. Tap **done**.

Deleting stock quotes or indices

1. While viewing stocks, tap  > **edit**.
2. Tap each stock quote or index you want to delete.
3. Tap **done** to delete them.

Changing the price rise color and other settings



Downloading stock information automatically may incur extra data fees.

1. While viewing a stock's trading chart and other details, tap  > **settings**.
2. Change the color for displaying stock price increases to either red or green, depending on what's being used in your country.
3. Choose other options such as the update schedule, and more.
4. Press  to apply the new settings.

Reading news feeds

Don't get left behind with yesterday's stories. In HTC, subscribe to news feeds that cover breaking news, sports, top blogs, and more.

Subscribing to news channels

1. On the Start screen, slide to the left.
2. Tap **HTC**.
3. Slide left or right until you see the list of subscribed **news** channels.

4. To subscribe and add a news channel, tap .
5. You can:
 - Tap a category, and then select one or more channels to subscribe to. After you've finished selecting, press  twice to return to the list of subscribed channels.
 - Or tap  to search for a specific keyword or a feed URL. Select one or more channels to subscribe to, and then tap .

Reading news

1. Tap a subscribed news channel to see stories from that channel, or tap **All items** to see the stories from all your subscribed channels.
2. Tap a story that you want to read.
3. While reading the news summary, you can:

Tap	To
	Go to the web page where the story is published and read the full article.
	Share the link to the story from available options.
 	Go to the previous or next story.

Want instant updates to a subscribed news channel?

Just pin your favorite news channel to the Start screen.

In the list of subscribed news channels, press and hold your favorite channel, and then tap **pin to start**.

A live tile for your favorite channel will be added to your Start screen, and it will show the headline of the latest story.

Unsubscribing news channels

- To unsubscribe a single news channel, press and hold that channel, and then tap **unsubscribe**.
- To unsubscribe several channels, tap **••• > unsubscribe**.

What's in the Office hub?

Microsoft Office Mobile includes mobile versions of Microsoft Office applications. You'll find them in the Office hub. You can also use the Office hub to access and edit documents that are stored online.

1. On the Start screen, slide to the left.
2. Tap Office.
3. Slide left or right across the screen to see your documents and other stuff.

recent Lists all documents you've recently opened or saved.

The **recent** screen also lets you find, open, or create Excel®, PowerPoint®, and Word documents.

places Access your Office documents that are stored on your phone or online, such as in SkyDrive, Microsoft SharePoint®, or Office 365.

What types of files can be opened in Office Mobile?

Office Mobile app	File formats
Word Mobile	.doc, .docx, .dot, .dotx, .dotm, .docm .txt, .rtf
Excel Mobile	.xls, .xlsx, .xlt, .xltx, .xlsm, .xltm
PowerPoint Mobile	.ppt, .pptx, .pps, .ppsx, .pptm, .ppsm

Xbox LIVE in the Games hub

Gaming on your phone is a truly social experience. With Xbox LIVE, Microsoft's gaming service, play games with your friends and use your avatar and gamer profile to keep track of game scores and achievements online through the Games hub.



Xbox LIVE or Store may not be available in some countries or regions.

1. On the Start screen, tap .
2. Slide left or right across the screen and check what games are available.

collection View all Xbox LIVE and other games that you have on your phone in one place. Just tap a game to start playing. You can also download more games from Store.

xbox Sign in to your Xbox LIVE account from here. You'll then be able to check or edit your profile, see your game achievements, and even personalize your avatar.

spotlight Read up on Xbox LIVE game news, tips, and trends from the Xbox LIVE team.



From the Games hub, you can also connect to and extend your gaming experience to your computer and your Xbox console.

Downloading and installing Xbox LIVE Extras

Customize your avatar on the go with Xbox LIVE Extras. You can download this app for free.

1. On the Games hub, slide left or right to go to **xbox**.
2. Tap your name. Your phone then searches Store for the Xbox LIVE Extras app.
3. Follow the onscreen instructions to download and install the app.

Tap **create avatar** (or **avatar**) and start customizing your avatar.

Bluetooth and NFC

Connecting a Bluetooth accessory

You can connect a variety of Bluetooth accessories such as headsets, car kits, or speakers to your phone.



- To listen to music, use an accessory such as a Bluetooth stereo headset that supports the A2DP profile.
- Before connecting, make sure to set the accessory to discoverable. To find out how, please refer to the accessory's manual.

1. On the Start screen, slide to the left.
2. Tap **Settings** > **Bluetooth**.
3. Tap the **On/Off** switch to turn Bluetooth on. Your phone becomes discoverable. It also automatically searches for Bluetooth devices within range.
4. Tap the name of the accessory that you want to pair with your phone.
5. If auto pairing fails, enter the pairing code supplied with the accessory.

When the accessory is connected to your phone, the Bluetooth icon appears on the status bar. You can also check the connection status shown below the accessory name on the **Bluetooth Settings** screen.



Turn Bluetooth off when not in use to save battery power, or in places where using a wireless device is prohibited, such as on board an aircraft and in hospitals.

Disconnecting a Bluetooth accessory

1. On the Start screen, slide to the left.
2. Tap **Settings** > **Bluetooth**.
3. Tap the accessory to disconnect it.

To reconnect, just tap the accessory again.

Unpairing

If you no longer want to use a connected accessory with your phone, you can unpair and remove it from your phone.

1. On the Start screen, slide to the left.
2. Tap **Settings** > **Bluetooth**.
3. Press and hold the name of the accessory, and then tap **delete**.

Sharing content with NFC

With built-in NFC (near field communication), you can share content with people easily just by placing your phone back to back with another phone that has Windows Phone 8 and NFC. Share a webpage you're viewing, contact information, and more.

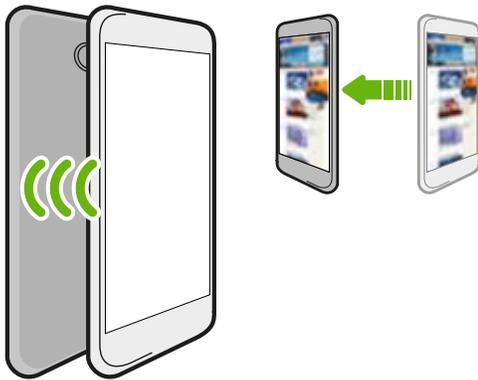

Turning NFC on and off

1. On the Start screen, slide to the left.
2. Tap **Settings** > **tap+send**.
3. Tap the **NFC sharing On/Off** switch.

Using NFC



Before using NFC, you must enable Bluetooth.

1. Follow the steps for the item you want to share:

Contact	<ol style="list-style-type: none">1. Select a contact to share.2. Tap ⋮ > share contact > .
Music	<ol style="list-style-type: none">1. In Music+Videos, slide to the songs list.2. Press and hold the name of the song, and then tap share.
Office document	<ol style="list-style-type: none">1. Find the document you want to share.2. Tap ⋮ > share.
Photo	<ol style="list-style-type: none">1. Find the photo you want to share.2. Tap ⋮ > share.
Web page	<ol style="list-style-type: none">1. View the web page you want to share.2. Tap ⋮ > share page.

2. Tap Tap+Send.
3. Briefly touch the other Windows Phone 8 phone back to back with your phone. The other phone will be asked to accept or ignore the transfer.

Settings

Attentive phone features

When your phone rings or during a call, it can sense and automatically respond to your actions or environment. You can go to the settings to find out what smart features your phone has in store for you.

1. On the Start screen, slide to the left.
2. Tap **Settings > attentive phone**.
3. You'll find these settings:

Quiet ring on pickup	Lowens the ring volume automatically when you hold and pick up your phone.
Pocket Mode	Makes your phone ring louder when it's in your pocket or bag so you won't miss calls. When your phone is not in your pocket or bag, it rings at the normal volume you've set.
Flip to mute ringer	Silences the ringer automatically when you flip your phone over.

If there's any setting you'd like to disable, just clear its check box.

Turning Battery Saver on

When you turn Battery Saver on, your phone automatically turns off some services and features that use battery in the background.

1. On the Start screen, slide to the left.
2. Tap **Settings > battery saver**.
3. Tap the **On/Off** switch to turn Battery Saver on.
4. Tap **advanced**, and then select any of these options:
 - **When battery is low.** Battery Saver automatically turns on whenever the battery gets to 20%.
 - **Now until next charge.** Battery Saver turns on instantly until the next time you recharge the battery.
 - **Always.** Battery Saver is always on.
5. Press **←** to save your settings.

Changing display settings

Adjusting the screen brightness manually

1. On the Start screen, slide to the left.
2. Tap **Settings** > **brightness**.
3. Tap the **Automatically adjust On/Off** switch to turn it off.
4. Select the **Level** of brightness to use.

Setting the time delay before the screen turns off

After a period of inactivity, the screen turns off automatically to save battery power. You can set the idle time before the screen turns off.

1. On the Start screen, slide to the left.
2. Tap **Settings** > **lock screen**.
3. Tap **Screen times out after**, and then select the time length that you want.

Changing sound settings

Setting your phone to silent mode

When you keep pressing the VOLUME DOWN button until the volume level reaches zero, this makes your phone vibrate only. To be able to switch your phone to silent mode using the VOLUME DOWN button, you need to turn vibrate off in the settings.

1. On the Start screen, slide to the left.
2. Tap **Settings** > **ringtones+sounds**.
3. Tap the **Vibrate On/Off** switch to turn vibrate off.

Choosing notification sounds

Choose different sounds for different types of notifications. You can use different sounds for incoming text or chat messages, voicemail, and email notifications.

1. On the Start screen, slide to the left.
2. Tap **Settings** > **ringtones+sounds**.
3. Tap the box for each notification type, and then choose a sound to assign to it. You can also turn on or off notification sounds for reminders and actions such as keypress, camera shutter, and more.

Managing apps and storage

Changing application settings

In most cases, you can change the settings for an app only when you're inside that app. For some apps, you can change their settings without having to open the apps.

1. On the Start screen, slide to the left.
2. Tap **Settings**.
3. Flick left to go to **applications**.
4. Tap an app or category to see what settings are available and choose the settings that you want.

Uninstalling an app

If you're running out of phone storage, free up some space by removing apps you no longer use.

Uninstalling an app also removes any information the app contained. Please remove apps with care.



Most preinstalled apps cannot be uninstalled.

1. On the Start screen, slide to the left.
2. Press and hold an app, and then tap **uninstall**.

Checking phone storage

You can easily check how much phone storage is left so you don't get short of space when saving important stuff.

1. On the Start screen, slide to the left.
2. Tap **Settings > phone storage**. The used and available phone storage is displayed.
3. To know what's using your phone storage, tap the phone storage bar.

Checking phone info

You can find out various information about your phone such as the Windows Phone software version, RAM size, screen resolution, and more.

1. On the Start screen, slide to the left.
2. Tap **Settings > about**.
3. Tap **more info** to see the Windows Phone update version and other details.

Security

Protecting your SIM card with a PIN

Add another layer of security by assigning a PIN (personal identification number) to your SIM card.



Make sure you have the default SIM PIN provided by your mobile operator before continuing.

1. On the Start screen, slide to the left.
2. Tap **Settings**.
3. Flick left to go to **applications**, and then tap **phone**.
4. Tap the **SIM security On/Off** switch to turn it on.
5. Enter the default SIM card PIN, and then tap **enter**.
6. To change the SIM card PIN, tap **Change SIM PIN**, and then enter a new PIN.

Restoring a SIM card that has been locked out

If you enter the wrong PIN more times than the maximum number of attempts allowed, your SIM card will become “PUK-locked.”



You need a PUK code to restore access to your SIM card. You can get this code from your mobile operator.

1. On the Phone dialer screen, enter the PUK code, and then tap **enter**.
2. Enter the new PIN, tap **enter**, and then reconfirm the new PIN.

Protecting your phone with a password

Protect your personal information and prevent others from using your phone without your permission by setting a password.

You'll be asked to enter the password every time you turn on your phone or when the phone resumes after it's left idle for a certain time.

1. On the Start screen, slide to the left.
2. Tap **Settings > lock screen**.
3. Tap the **Password On/Off** switch to turn it on.

4. Enter your password in both the **New password** and **Confirm password** boxes.
5. Tap **done**.

Making your phone safe for kids

Your phone is a great way to entertain your kids. Use Kid's Corner to prevent accidental calls while kids play with your phone. With Kid's Corner, you can also limit access to games, music, videos, and apps on your phone.

Setting up Kid's Corner

1. On the Start screen, slide to the left.
2. Tap **Settings > kid's corner**.
3. Tap **next**.
4. Choose which content kids can access when your phone is in Kid's Corner mode.
5. Tap **next** and then tap **set password** or **skip**.



Setting a password adds an extra layer of security when returning from Kid's Corner.

6. Tap **launch kid's corner**. The Kid's Corner lock screen appears.
7. Drag the lock screen up to show the Kid's Corner screen.
8. Tap **Customize** to give a name to your Kid's Corner screen, choose a Kid's Corner lock screen picture, and more.

Launching Kid's Corner



You'll receive calls and text messages even while your phone is in Kid's Corner mode.

1. If the phone is on, briefly press the **POWER** button to turn off the display and switch the phone to Sleep mode.
2. Briefly press the **POWER** button again to wake your phone up.

3. Slide to the left of the lock screen. The Kid's Corner lock screen displays.
4. Swipe your finger up the lock screen. You can now let your kids play with your phone.

Closing and disabling Kid's Corner

Close and disable Kid's Corner if you no longer need it.

1. From the Kid's Corner screen, briefly press the POWER button to turn off the display and switch the phone to Sleep mode.
2. Briefly press the POWER button again to wake your phone up.
3. Swipe your finger up the lock screen.
4. On the Start screen, slide to the left.
5. Tap **Settings > kid's corner**.
6. Tap the **On/Off** switch to disable Kid's Corner.

Update and reset

How to get and install updates

From time to time, software updates may be available. Your phone can check and notify you if there's a new update.

Setting update notification and downloading option

You can set your phone to notify you when new updates are available for your phone. You can also allow your phone to automatically download those updates.

1. On the Start screen, slide to the left.
2. Tap **Settings** > **phone update**.
3. Select the **Tell me when updates are available for my phone** check box.
4. Choose whether you want to allow automatic downloading of updates if your data settings allow it. If you disable this option, your phone will only download updates over Wi-Fi or when it's connected to your computer.

Preparing for a software update

To make sure a software update can be carried out smoothly and without interruptions, prepare your phone for the update. Here's what you need to check.

- If your battery level is low, give your phone a quick charge before starting the update.
- Check how much free space you have on your phone and make some room for the update. To find out how to check the available storage, see [Checking phone storage](#) on page 86.

If necessary, remove a few unwanted apps. Refer to [Uninstalling an app](#) on page 86 to see how it's done.

Or delete large files (such as photos, videos, or music) from your phone.

- Make sure your phone is set with the correct date and time. This determines which new updates you'll need. For details, see [Correcting the date and time](#) on page 91.

Installing an update

When you see the notification about an available software update, you can update your phone right away. Or you can dismiss the notification and update some other time. Your phone will remind you again in a few days.



Have you prepared your phone for the update? If you haven't, please see [Preparing for a software update](#) on page 90 on what you should check and prepare.

Correcting the date and time

If you're having trouble installing a software update, your phone may not have been set with the correct date and time. In most cases, the date and time is set automatically. But if it's not, you can set it manually.

1. Disconnect your phone from your computer.
2. On the Start screen, slide to the left.
3. Tap **Settings** > **date+time**.
4. Turn off **Set automatically**.
5. Set the correct time zone, date, and time.
6. Reconnect your phone to your computer, and then try installing the update again.

Factory reset

Do a factory reset to change your phone back to its original state before the first time you turned it on.

If you're passing your phone on to someone else or your phone has a persistent problem that cannot be solved, you can perform a factory reset (also called a hard reset). Factory reset is not a step to be taken lightly. It'll permanently delete all your data and customized settings, and will remove any apps you've downloaded and installed. Be sure to back up any data and files you want to keep before you do a factory reset.

Performing a factory reset via settings

The most convenient way to do a factory reset is via the settings.

1. On the Start screen, slide to the left.
2. Tap **Settings** > **about**.
3. Tap **reset your phone**, and then tap **yes**.

Performing a factory reset using phone buttons

If you can't turn your phone on or access settings, you can still perform a factory reset by using the phone's buttons.

1. Turn the power off.
2. Press and hold the VOLUME DOWN button, and then briefly press the POWER button. Release the VOLUME DOWN button when you see an icon on the screen.
3. Then press the following hardware buttons in sequence: VOLUME UP > VOLUME DOWN > POWER > VOLUME DOWN.

Trademarks and copyrights

©2012 HTC Corporation. All Rights Reserved.

HTC, the HTC logo, and the HTC quietly brilliant logo are trademarks of HTC Corporation.

Microsoft, Windows, Windows Phone, ActiveSync, Bing, Excel, Hotmail, Internet Explorer, OneNote, Outlook, PowerPoint, SharePoint, SkyDrive, Windows Live, Windows Media, Windows Vista, Xbox LIVE, and Zune are either registered trademarks or trademarks of Microsoft Corporation in the United States and/or other countries.

Google, the Google logo, and Gmail are trademarks of Google Inc.

The *Bluetooth*[®] word mark and logos are registered trademarks by Bluetooth SIG, Inc. and any use of such marks by HTC Corporation is under license.

Wi-Fi[®] is a registered trademark of the Wireless Fidelity Alliance, Inc.

All other company, product and service names mentioned herein are trademarks, registered trademarks or service marks of their respective owners.

Screen images contained herein are simulated. HTC shall not be liable for technical or editorial errors or omissions contained herein, nor for incidental or consequential damages resulting from furnishing this material. The information is provided “as is” without warranty of any kind and is subject to change without notice. HTC also reserves the right to revise the content of this document at any time without prior notice.

No part of this document may be reproduced or transmitted in any form or by any means, electronic or mechanical, including photocopying, recording or storing in a retrieval system, or translated into any language in any form without prior written permission of HTC.

Index

Symbols

3G

- access point 58
- roaming 58
- turning on or off 57

A

Access point 58

Airplane mode 33

Appointment

- creating 71

Apps

- managing 86
- settings 86
- switching between apps 23
- uninstalling 86

B

Battery 11

Battery Saver 84

Bing Search 61

Bluetooth 81

Browser 64

C

Calendar 71

Call history 32

Camera

- settings 27

Chat 44

Check in

- Facebook 41
- Microsoft Account 41

Conference call 31

Connection Setup 57

Contacts

- about 34
- adding 34
- adding a new number from call history 32
- deleting a contact 36

- deleting a contact group 39
- editing 36
- groups 38
- importing from SIM card 34
- merging 35
- searching 36

D

Data connection

- access point 58
- roaming 58
- turning on or off 57

Date and time

- setting manually 91

Delete

- account 14
- contact groups 39
- contacts 36
- Start screen tile 16

Display

- adjusting screen brightness 85
- setting delay before screen turns off 85

Download apps 24

E

Email

- deleting 51
- Exchange ActiveSync 49
- inboxes 50
- Microsoft Account 48
- moving 51
- POP3/IMAP 48
- sending 50
- settings 52

Emergency calls 29

Exchange ActiveSync email 49

F

Facebook

- chatting 44

- checking in 41
- profile 40
- setting up 13
- sharing photos and videos 54

Factory reset 91

Firmware updates 91

Flight mode 33

G

Games hub 80

Google Account 13

H

Hands free 81

Hard reset 91

Home screen 16

HTC hub 74

I

International calls 29

Internet connection

- data connection 57
- Wi-Fi 58

Internet Sharing 60

L

Local Scout 69

Location services 66

Lock screen 21

M

Maps

- finding an address or place 67
- getting directions 69
- sharing an address 68

Master reset 91

Messaging

- deleting or forwarding messages 47
- replying to a message 46
- sending a message 44
- sharing a photo 45

Microsoft Account

- chatting 44
- checking in 41
- profile 40
- setting up 13, 48

Microsoft Office 79

Microsoft Tag 62

MMS 45

Mobile hotspot 60

Music

- playing 55

Mute microphone in a call 31

N

News feeds 77

Notification sounds 85

O

Office hub 79

Online accounts 13

Outlook email 49

P

Pairing 81

Password lock 87

People 34

Phone

- answering or rejecting a call 30
- call history 32
- conference calling 31
- emergency calls 29
- international calls 29
- making a call 29
- mute 31
- speakerphone 30
- switching between call 31

Phone information 86

Phone updates 91

Photos

- sharing 45, 54
- viewing 53

Pictures 53

Podcasts

- playing 55

Power

- sleep mode 21

Profile

- Facebook 40
- Microsoft Account 40

Pushpins 68

Q

QR Code 62

R

- Reset *91*
- Ringer *20*
- Ringtone
 - changing *22*
 - volume *20, 85*
- Roaming *58*

S

- Screen
 - adjusting screen brightness *85*
 - setting delay before screen turns off *85*
 - unlocking *21*
 - wallpaper *22*
- Search
 - contacts *36*
 - scanned items *62*
 - Web search *61*
- Silent mode *20, 85*
- SIM card
 - assigning PIN *87*
 - contacts *34*
- SkyDrive
 - sharing photos and videos *54*
- Sleep mode *21*
- Software updates *91*
- Sounds
 - flip to mute ringer *84*
 - notifications *85*
 - pocket mode *84*
 - quiet ring on pickup *84*
 - ringtone *22*
 - silent *20, 85*
 - volume *20, 85*
- Speakerphone *30*
- Speech commands *24*
- Start screen
 - about *16*
 - adding items *16*
 - personalizing *23*
 - rearranging items *16*
 - removing items *16*
- Stocks *75*
- Storage space *86*
- Store *24*

- Sync
 - email sync settings *52*

T

- Text messages *44*
- Themes *23*
- To-do task
 - creating *72*
- Translation *62*

V

- Vibrate *20*
- Videos
 - sharing *54*
 - watching *53, 55*
- Voice commands *24*
- Volume *20, 85*

W

- Wallpaper *22*
- Weather *74*
- Web Browser *64*
- Wi-Fi
 - about *58*
 - connecting *58*
 - disconnecting *59*
 - hidden network *59*

X

- Xbox LIVE *80*