

# Quick Start Manual

## ST5500



For more information, refer to the User Manual included on the supplied **CD-ROM**.

This Quick Start Manual has been specially designed to guide you through the basic functions and features of your device. Please read the Quick Start Manual and User Manual carefully to ensure safe and correct use.

ENG / GER / FRE / SPA / ITA / DUT / POR

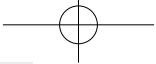

# Contents



Health and safety information	2	1
Camera layout .....	4	15
Setting up your camera .....	5	14
Unpacking .....	5	
Inserting the battery and memory card .....	6	
Charging the battery .....	6	
Turning on your camera.....	7	
Using the touch screen .....	7	
Capturing photos or videos	8	27
Playing files .....	9	66
Transferring files to a PC (Windows) .....	9	86
Using photo or video sharing websites.....	10	101
Specifications .....	11	126

# Health and safety information



## Warnings

### Do not use your camera near flammable or explosive gases and liquids

Do not use your camera near fuels, combustibles, or flammable chemicals. Do not store or carry flammable liquids, gases, or explosive materials in the same compartment as the camera or its accessories.

### Keep your camera away from small children and pets

Keep your camera and all accessories out of the reach of small children and animals. Small parts may cause choking or serious injury if swallowed. Moving parts and accessories may present physical dangers as well.

### Prevent damage to subjects' eyesight

Do not use the flash in close proximity (closer than 1m/ 3 ft) to people or animals. Using the flash too close to your subject's eyes can cause temporary or permanent damage.

### Handle and dispose of batteries and chargers with care

- Use only Samsung-approved batteries and chargers. Incompatible batteries and chargers can cause serious injuries or damage to your camera.
- Never place batteries or cameras on or in heating devices, such as microwave ovens, stoves, or radiators. Batteries may explode when overheated.



### Handle and store your camera carefully and sensibly

- Do not allow your camera to get wet—liquids can cause serious damage. Do not handle your camera with wet hands. Water damage to your camera can void your manufacturer's warranty.
- Avoid using or storing your camera in dusty, dirty, humid, or poorly-ventilated areas to prevent damage to moving parts and internal components.
- Exercise caution when connecting cables or adapters and installing batteries and memory cards. Forcing the connectors, improperly connecting cables, or improperly installing batteries and memory cards can damage ports, connectors, and accessories.

- Do not insert foreign objects into any of your camera's compartments, slots, or access points. This type of damage may not be covered by your warranty.

### Protect batteries, chargers, and memory cards from damage

- Avoid exposing batteries or memory cards to very cold or very hot temperatures (below 0° C/32° F or above 40° C/104° F). Extreme temperatures can reduce the charging capacity of your batteries and can cause memory cards to malfunction.
- Do not allow liquids, dirt, or foreign substances to come in contact with memory cards or the memory card slot. Doing so may cause memory cards or the camera to malfunction.
- Do not use memory cards that have been formatted by other cameras or by a computer. Reformat the memory card with your camera.

### Follow all safety warnings and regulations

Comply with any regulations that restrict the use of a camera in a certain area.

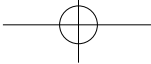

## Camera layout

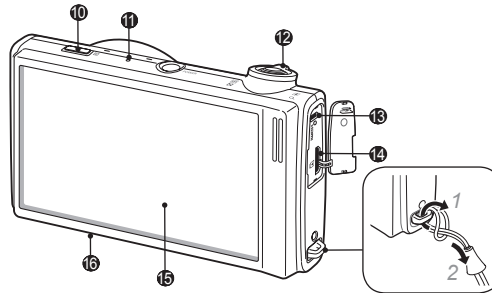
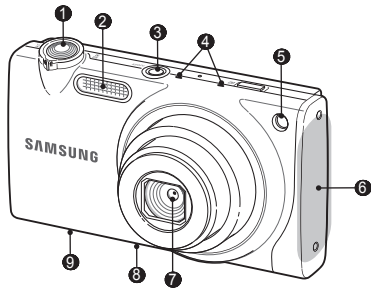

- ❶ Shutter button
- ❷ Flash
- ❸ POWER button
- ❹ Microphone
- ❺ AF-assist light/timer lamp
- ❻ Internal antenna
- ❼ Lens
- ❽ Speaker
- ❾ Battery chamber cover

- ❿ Playback button
- ⓫ Status lamp
- ⓬ Zoom button
- ⓭ HDMI port (Accepts HDMI cable)
- ⓮ USB and A/V port (Accepts USB cable or A/V cable)
- ⓯ Touch screen
- ⓰ Tripod mount



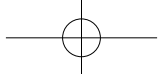

# Setting up your camera

## Unpacking

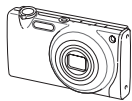

Camera



AC adapter/  
USB cable



Rechargeable battery



Strap



Quick Start Manual

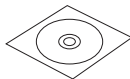

User Manual CD-ROM

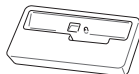

Cradle

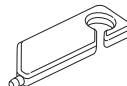

Touch pen

## Optional accessories



Camera case



Memory card  
(microSD™)

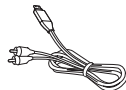

A/V cable



Battery charger

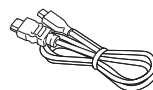

HDMI cable

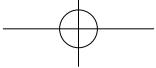

## Setting up your camera

### Inserting the battery and memory card

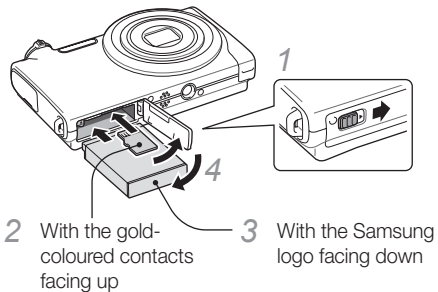

#### ▼ Removing the battery

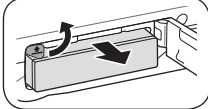

#### ▼ Removing the memory card

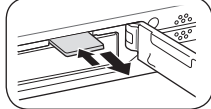

Push gently until the card disengages from the camera and then pull it out of the slot.

6

### Charging the battery

Before using the camera for the first time, you must charge the battery.

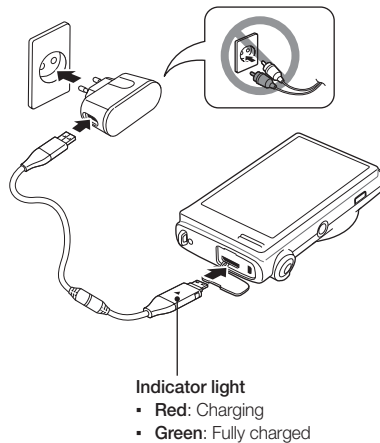

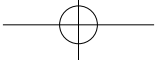

## Turning on your camera

- 1 Press **[POWER]** to turn your camera on or off.
  - The initial setup screen appears when you turn on your camera for the first time.

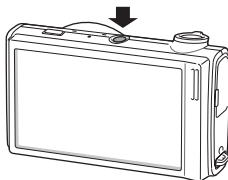

- 2 Select a language, set the date and time, select a time zone, and calibrate the screen.

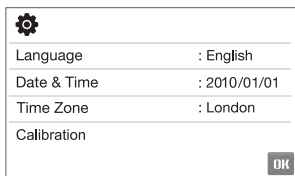

## Using the touch screen

Use the supplied touch pen to touch or drag on the screen.



Do not use other sharp objects, such as pens or pencils, to touch the screen. Doing so may damage the screen.

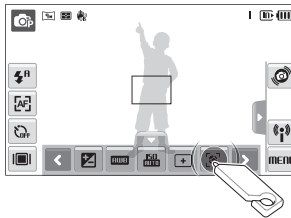

**Touching**  
Touch an icon to open a menu or set an option.

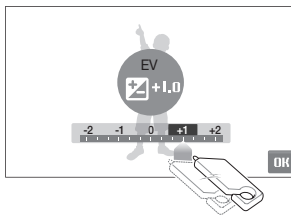

**Dragging**  
Drag left or right to scroll horizontally.

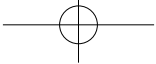

## Capturing photos or videos

### Taking a photo

- 1 Make sure that the camera is in the mode (Auto mode).
- 2 Align your subject in the frame.
- 3 Press **[Shutter]** halfway down to focus automatically.
  - A green frame means the subject in focus.

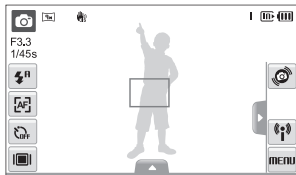

- 4 Press **[Shutter]** all the way down to take the photo.

### Recording a video

- 1 Select → .
- 2 Align your subject in the frame.
- 3 Press **[Shutter]**.
  - To pause, select .
  - To resume, select .
- 4 Press **[Shutter]** again to stop recording.

#### Note

#### Number of photos by resolution (for 1 GB microSD™)

	Resolution	Super fine	Fine	Normal
	4320 X 3240	122	240	353
	4000 X 3000	142	278	409
	3984 X 2656	160	312	454
	3840 X 2160	206	401	588
	3264 X 2448	211	409	594
	2560 X 1920	335	637	908
	2048 X 1536	510	936	1,314
	1920 X 1080	762	1,373	1,931
	1024 X 768	1,626	2,575	3,090

These figures are measured under Samsung's standard conditions and may vary depending on shooting conditions and camera settings.

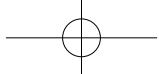

## Playing files

### Viewing photos

- 1 Press **[Playback]**.
- 2 Draw a horizontal bar left or right, or select **◀** or **▶** to scroll through photos.
  - You can also view files by tilting your camera.

### Viewing videos

- 1 Press **[Playback]** and select **▶**.
- 2 Use the following icons to control playback.

	Scan backward
	Pause or resume playback
	Stop playback
	Scan forward
	Adjust volume or mute sound

## Transferring files to a PC (Windows)

- 1 Connect the camera to your computer with the USB cable.

### Note

Make sure that the **PC Software** option is set to **On** in the settings menu.

- 2 Turn on the camera.
  - The computer recognizes the camera automatically.
  - For Windows Vista, select **Run iStudio.exe** from the AutoPlay window.
- 3 Select a folder on your computer to save new files.
  - If your camera has no new files, the window to save new files will not appear.
- 4 Select **Yes**.
  - New files will be transferred to your computer. You can now use the Intelli-studio program.

### Note

#### About Intelli-studio

Intelli-studio is a built-in program that allows you to play back and edit files. You can also upload files to websites, such as Flickr or YouTube.

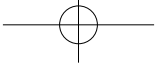

## Using photo or video sharing websites

### Accessing a website

- 1 In Shooting or Playback mode, select → .
  - The camera will search for and display available AP devices.
- 2 Select an AP device.
  - The camera will connect to the WLAN.
  - If the selected AP device requires a password, enter a password.
  - If the camera fails to connect to the WLAN automatically, connect to it manually. For more information about connecting to the WLAN, contact your network administrator or network service provider.
- 3 Select a website.
- 4 Enter your login ID and password, and select **Login**.

### Uploading photos or videos

- 1 Select .
- 2 Select or to scroll through files.
- 3 Drag photos or videos to the selection area or select photos or videos, and select **OK**.

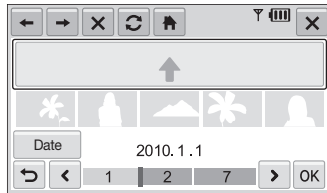

- Select **Date** to categorize the files.
- 4 Enter a title and select an album, and then select .

#### Note

- The speed of your internet connection may affect how quickly photos upload or web pages open.
- You may not be able to send an email due network connection or email account settings.

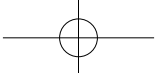

## Specifications

Image sensor	<ul style="list-style-type: none"><li>Type: 1/2.3" (Approx. 7.76 mm) CCD</li><li>Effective pixels: approx. 14.2 mega-pixels</li><li>Total pixels: approx. 14.5 mega-pixels</li></ul>
Lens	<ul style="list-style-type: none"><li>Focal length: Schneider-KREUZNACH lens f = 5.6 - 39.2 mm (35 mm film equivalent: 31 - 217 mm)</li><li>F-stop range: F3.3 (W) - F5.5 (T)</li></ul>
Display	3.7" (9.4 cm) Wide Full Touch Screen Panel
Focusing	TTL auto focus (Multi AF, Center AF, Face Recognition AF, Face Detection AF, Smart Touch AF, One Touch Shooting)
Shutter speed	<ul style="list-style-type: none"><li>Auto: 1/8 - 1/2,000 sec.</li><li>Program: 1 - 1/2,000 sec.</li><li>Night: 8 - 1/2,000 sec.</li><li>Fireworks: 2 sec.</li></ul>
Storage	<ul style="list-style-type: none"><li>Internal memory: approx. 13 MB</li><li>External memory (Optional): microSD™ card (up to 4 GB guaranteed)</li></ul> Internal memory capacity may not match these specifications.
DC power input connector	20 pin, 4.4 V
Rechargeable battery	Lithium-ion battery (SLB-11A, 1130 mAh)
Dimensions (W x H x D)	103.8 x 58.3 x 19.6 mm
Weight	161.1 g (without battery and memory card)
Operating temperature	0 - 40° C
Operating humidity	5 - 85%

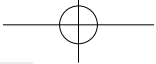

## Inhalt

Hinweise zu Sicherheit und Gesundheit .....	2	1
Aufbau der Kamera .....	4	15
Inbetriebnahme der Kamera .....	5	14
Auspacken .....	5	
Akku und Speicherkarte einsetzen .....	6	
Akku aufladen .....	6	
Kamera einschalten .....	7	
Touchscreen verwenden .....	7	
Fotos und Videos aufnehmen .....	8	27
Dateien wiedergeben .....	9	66
Dateien auf einen PC (Windows) übertragen .....	9	86
Foto- oder Videosharing-Webseiten nutzen .....	10	101
Technische Daten .....	11	126



DE-2

## Hinweise zu Sicherheit und Gesundheit

### **Warnungen**

#### **Verwenden Sie die Kamera nicht in der Nähe von leicht entzündlichen oder explosionsgefährdeten Gasen oder Flüssigkeiten**

Verwenden Sie die Kamera nicht in der Nähe Kraftstoffen, brennbaren Materialien oder entzündlichen Chemikalien. Lagern und transportieren Sie entzündliche Flüssigkeiten, Gase oder explosive Materialien nicht am selben Platz, an dem sich die Kamera oder ihr Zubehör befindet.

#### **Halten Sie Kleinkinder und Haustiere von Ihrer Kamera fern**

Achten Sie darauf, dass die Kamera und sämtliches Zubehör nicht in die Reichweite kleiner Kinder oder Haustiere gelangen. Kleine Teile können zum Erstickern oder schweren Verletzungen beim Verschlucken führen. Auch bewegliche Teile und Zubehörteile können Gefahren darstellen.

#### **Verhindern Sie Augenschäden bei aufgenommenen Lebewesen**

Verwenden Sie den Blitz nicht zu nahe (nicht näher als 1 m) an den Augen von Menschen und Tieren. Wenn der Blitz zu nahe bei den Augen eingesetzt wird, kann dies zu vorübergehenden oder dauerhaften Sehschäden führen.



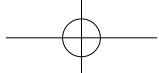

### Behandeln und entsorgen Sie Akkus und Ladegeräte mit Sorgfalt

- Verwenden Sie nur von Samsung zugelassene Akkus und Ladegeräte. Inkompatible Akkus und Ladegeräte können schwere Verletzungen bzw. Schäden an der Kamera verursachen.
- Legen Sie weder Akkus noch die Kamera auf oder in Heizgeräte wie Mikrowellen, Öfen oder Heizkörper. Die Akkus können dadurch überhitzen und explodieren!



### Achtung

### Behandeln und lagern Sie die Kamera sorgfältig und vernünftig

- Lassen Sie Ihre Kamera nicht nass werden – Flüssigkeiten können schwere Schäden hervorrufen. Fassen Sie die Kamera nicht mit nassen Händen an. Wasser beschädigt die Kamera und kann zum Erlöschen der Herstellergarantie führen.
- Bewahren Sie die Kamera nicht in staubigen, schmutzigen, feuchten oder schlecht belüfteten Bereichen auf, damit die beweglichen Teile und inneren Komponenten keinen Schaden nehmen.
- Wenden Sie Sorgfalt an, wenn Sie Kabel oder Adapter anschließen oder Akkus oder Speicherkarten einsetzen.

Gewaltsames Einstecken von Steckern, falsche Verbindungskabel oder unsachgemäß eingesetzte Akkus und Speicherkarten können Anschlüsse, Steckverbinder und Zubehörteile beschädigen.

- Stecken Sie keine Fremdkörper in die Fächer, Steckplätze oder Zugangspunkte der Kamera. Schäden dieser Art werden unter Umständen nicht von der Garantie abgedeckt.

### Schützen Sie Akkus, Ladegeräte und Speicherkarten vor Beschädigung

- Setzen Sie Akkus und Speicherkarten keinen sehr niedrigen oder sehr hohen Temperaturen aus (unter 0° C/32° F oder über 40° C/104° F). Extreme Temperaturen können die Ladekapazität von Akkus reduzieren und Fehlfunktionen von Speicherkarten verursachen.
- Flüssigkeiten, Schmutz oder Fremdkörper dürfen nicht mit Speicherkarten oder dem Speicherkartenslot in Kontakt kommen. Ansonsten kann es passieren, dass Ihre Speicherkarten oder Ihre Kamera nicht mehr richtig funktionieren.
- Verwenden Sie keine Speicherkarten, die bereits von anderen Kameras oder auf einem Computer formatiert worden sind. Formatieren Sie die Speicherkarte auf Ihrer Kamera neu.

### Befolgen Sie alle Sicherheitshinweise und Vorschriften

Beachten Sie Vorschriften, die die Verwendung einer Kamera in einem bestimmten Bereich verbieten.

DE-3

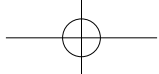

## Aufbau der Kamera

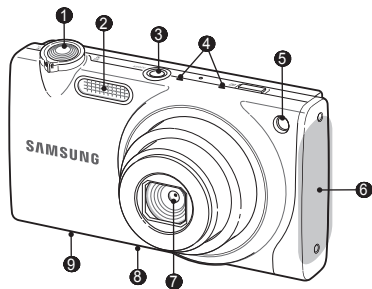

- ① Auslösertaste
- ② Blitzlicht
- ③ Ein/Aus-Taste
- ④ Mikrophon
- ⑤ AF-Lämpchen/Timer-Lämpchen
- ⑥ Interne Antenne
- ⑦ Objektiv
- ⑧ Lautsprecher
- ⑨ Akkufachabdeckung

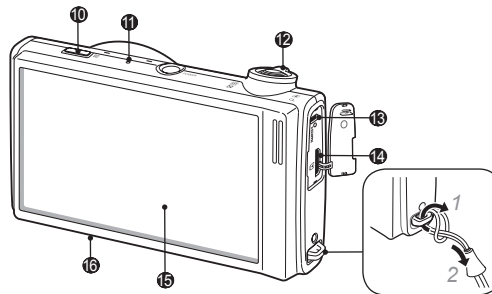

- ⑩ Wiedergabe-Taste
- ⑪ Statuslämpchen
- ⑫ Zoom-Taste
- ⑬ HDMI-Anschluss (Zum Anschließen eines HDMI-Kabels)
- ⑭ USB- und A/V-Anschluss (Zum Anschließen eines USB- oder A/V-Kabels)
- ⑮ Touchscreen
- ⑯ Stativgewinde

DE-4

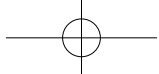

# Inbetriebnahme der Kamera

## Auspacken



Kamera



Netzadapter/  
USB-Kabel



Akku



Trageriemen



Kurzanleitung

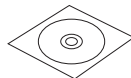

Bedienungsanleitung  
(CD-ROM)

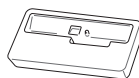

Ladestation

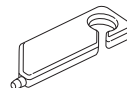

Bedienstift

Deutsch

## Optionales Zubehör



Kameratasche



Speicherkarte  
(microSD™)

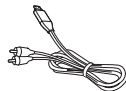

A/V-Kabel

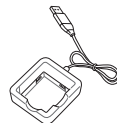

Akkuladegerät

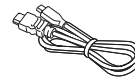

HDMI-Kabel

DE-5

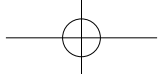

## Inbetriebnahme der Kamera

### Akku und Speicherkarte einsetzen

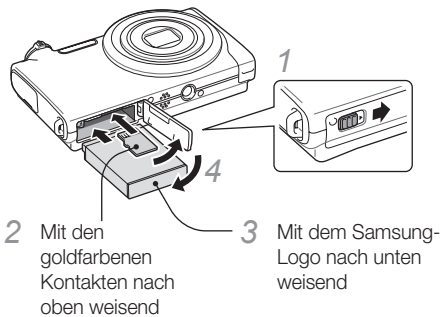

#### ▼ Akku entnehmen

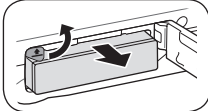

#### ▼ Speicherkarte entnehmen

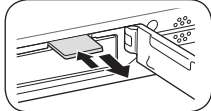

Drücken Sie vorsichtig gegen die Speicherkarte, so dass sie ausrastet, und ziehen Sie sie dann aus dem Speicherkarteneinschub.

DE-6

### Akku aufladen

Bitte laden Sie den Akku unbedingt auf, bevor Sie die Kamera verwenden.

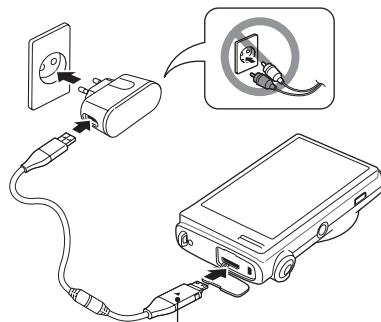

#### Anzeigelämpchen

- Rot: Laden
- Grün: Voll aufgeladen

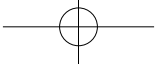

## Kamera einschalten

- Drücken Sie **[POWER]**, um die Kamera ein- oder auszuschalten.
  - Das Display für die anfängliche Einrichtung wird beim ersten Einschalten der Kamera angezeigt.

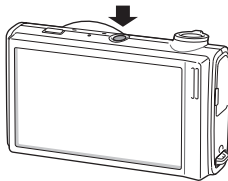

- Wählen Sie eine Sprache, stellen Sie das Datum und die Uhrzeit ein, wählen Sie eine Zeitzone, und kalibrieren Sie den Touchscreen.

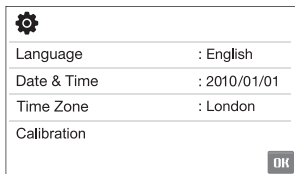

## Touchscreen verwenden

Mit dem mitgelieferten Bedienstift können Sie den Touchscreen berühren oder Bewegungen darauf ausführen.



### Vorsicht

Verwenden Sie keine spitzen Gegenstände wie Kugelschreiber oder Bleistifte, um den Touchscreen zu berühren. Dadurch kann der Touchscreen beschädigt werden.

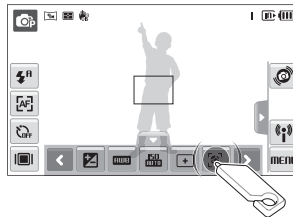

### Berühren

Berühren Sie ein Symbol, um ein Menü zu öffnen oder eine Option einzustellen.

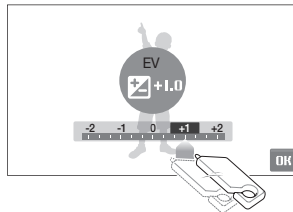

### Ziehen

Um waagrecht zu blättern, ziehen Sie den Bedienstift auf dem Touchscreen nach links oder rechts.

DE-7

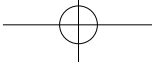

# Fotos und Videos aufnehmen

## Fotografieren

- 1 Vergewissern Sie sich, dass die Kamera sich im Modus (Automatikmodus) befindet.
- 2 Richten Sie Ihr Motiv im Rahmen aus.
- 3 Drücken Sie den **[Auslöser]** zur Hälfte, um automatisch zu fokussieren.
  - Ein grüner Rahmen bedeutet, dass das Motiv scharfgestellt ist.

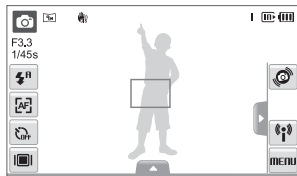

- 4 Drücken Sie den **[Auslöser]** ganz, um das Foto zu erstellen.

## Video aufzeichnen

- 1 Wählen Sie → .
- 2 Richten Sie Ihr Motiv im Rahmen aus.
- 3 Drücken Sie den **[Auslöser]**.
  - Zum Pausieren wählen Sie **II**.
  - Zum Fortsetzen der Aufnahme wählen Sie **●**.
- 4 Drücken Sie den **[Auslöser]** erneut, um die Aufnahme zu beenden.

### Hinweis

#### Anzahl Fotos nach Auflösung (für 1 GB microSD™)

	Auflösung	Superfein	Fein	Normal
<b>P</b>	4320 X 3240	122	240	353
<b>E</b>	4000 X 3000	142	278	409
<b>16</b>	3984 X 2656	160	312	454
<b>7</b>	3840 X 2160	206	401	588
<b>B</b>	3264 X 2448	211	409	594
<b>S</b>	2560 X 1920	335	637	908
<b>3</b>	2048 X 1536	510	936	1.314
<b>2</b>	1920 X 1080	762	1.373	1.931
<b>L</b>	1024 X 768	1.626	2.575	3.090

Diese Zahlen wurden unter den Standardbedingungen von Samsung gemessen und können sich je nach Aufnahmebedingungen und Kameraeinstellungen unterscheiden.

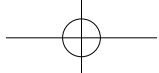

## Dateien wiedergeben

### Fotos anzeigen

- 1 Drücken Sie [**Wiedergabe**].
- 2 Zeichnen Sie einen horizontalen Strich nach links oder rechts oder wählen Sie ◀ oder ▶, um durch die Fotos zu blättern.
  - Die Kamera erkennt Ihr Gesicht automatisch.

### Videos anzeigen

- 1 Drücken Sie [**Wiedergabe**] und wählen Sie ▶.
- 2 Sie können die Wiedergabe mit folgenden Symbolen steuern.

◀◀	Rückwärtssuche
▶	Wiedergabe unterbrechen oder fortsetzen
■	Wiedergabe beenden
▶▶	Vorwärtssuche
🔊	Lautstärke anpassen oder Ton stumm schalten

## Dateien auf einen PC (Windows) übertragen

- 1 Schließen Sie die Kamera mit dem USB-Kabel an einen Computer an.

### • Hinweis

Vergewissern Sie sich, dass die Option **PC-Software** auf **Ein** im Einstellungsmenü eingestellt ist.

- 2 Schalten Sie die Kamera ein.
  - Die Kamera aktiviert automatisch den Auslöser, wenn sie ein lächelndes Gesicht erkennt.
  - Wählen Sie **Run iStudio.exe** für Windows Vista im Fenster AutoPlay.
- 3 Wählen Sie am Computer einen Ordner zum Speichern der neuen Dateien.
  - Falls auf Ihrer Kamera keine neuen Dateien vorhanden sind, wird das Popup-Fenster zum Speichern neuer Dateien nicht angezeigt.
- 4 Wählen Sie **Ja**.
  - Neue Dateien werden auf Ihren Computer übertragen. Jetzt können Sie das Programm Intelli-studio verwenden.

### • Hinweis

#### Info zu Intelli-studio

Intelli-studio ist ein integriertes Programm zum Wiedergeben und Bearbeiten von Dateien. Sie können außerdem Dateien zu Websites wie Flickr oder YouTube hochladen.

DE-9

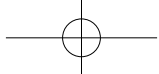

## Foto- oder Videosharing-Webseiten nutzen

### Webseite aufrufen

- 1 Wählen Sie im Aufnahme- oder Wiedergabemodus (📷) → 🌐.
  - Die Kamera sucht nach verfügbaren Zugangspunkt-Vorrichtungen und zeigt diese an.
- 2 Wählen Sie eine Zugangspunkt-Vorrichtung.
  - Die Kamera stellt die Verbindung zum WLAN her.
  - Wenn die ausgewählte Zugangspunkt-Vorrichtung ein Passwort erfordert, geben Sie das Passwort ein.
  - Falls die Kamera keine WLAN-Verbindung herstellt, stellen Sie die Verbindung manuell her. Wenden Sie sich für weitere Informationen zur Herstellung der WLAN-Verbindung an Ihren Netzadministrator oder Netzbetreiber.
- 3 Wählen Sie eine Webseite
- 4 Geben Sie Ihre Anmeldekennung und Ihr Passwort ein und wählen Sie **Login**.

### Fotos oder Videos hochladen

- 1 Wählen Sie 📁.
- 2 Wählen Sie ⬅ oder ➡, um durch Dateien zu blättern.
- 3 Ziehen Sie Fotos oder Videos in den Auswahlbereich oder wählen Sie Fotos oder Videos aus und wählen Sie **OK**.

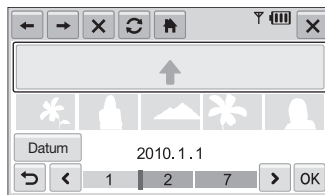

- Wählen Sie **Datum**, um die Dateien zu ordnen.
- 4 Geben Sie einen Titel ein und wählen Sie ein Album aus und wählen Sie dann 📁.
- Hinweis**
- Es hängt vor allem von der Geschwindigkeit Ihrer Internetverbindung ab, wie schnell Sie Fotos hochladen oder Webseiten öffnen können.
  - Unter Umständen kann eine E-Mail aufgrund der Netzverbindung oder aufgrund von Einstellungen des E-Mail-Kontos nicht übertragen werden.

DE-10



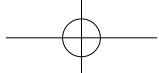

## Technische Daten

Bildsensor	<ul style="list-style-type: none"><li>• Typ: 1/2,3" (ca. 7,76 mm) CCD</li><li>• Effektive Pixel: ca. 14,2 Megapixel</li><li>• Gesamtpixel: ca. 14,5 Megapixel</li></ul>
Objektiv	<ul style="list-style-type: none"><li>• Brennweite: Schneider-KREUZNACH-Objektiv f = 5,6 - 39,2 mm (35-mm-Film-Äquivalent: 31 - 217 mm)</li><li>• Blendenwertbereich: F3,3 (W) - F5,5 (T)</li></ul>
Display	9,4 cm (3,7") Breitbild-Display, komplett als Touchscreen ausgelegt
Scharfeinstellung	TTL-Autofokus (Multi AF, Mitten AF, Gesichtserkennungs-AF, Gesichtserkennungs-AF, Smart Touch AF, One-Touch-Aufnahme)
Verschlusszeit	<ul style="list-style-type: none"><li>• Automatik: 1/8 - 1/2.000 s</li><li>• Programm: 1 - 1/2.000 s</li><li>• Nacht: 8 - 1/2.000 s</li><li>• Feuerwerk: 2 s</li></ul>
Speicher	<ul style="list-style-type: none"><li>• Interner Speicher: Ca. 13 MB</li><li>• Externer Speicher (optional): microSD™-Karte (bis zu 4 GB garantiert)</li></ul> Die interne Speicherkapazität kann von diesen Angaben abweichen.
Gleichstrom-eingangsanschluss	20-polig (4,4 V)
Akku	Lithium-Ionen-Akku (SLB-11A, 1.130 mAh)
Abmessungen (B x H x T)	103,8 x 58,3 x 19,6 mm
Gewicht	161,1 g (ohne Akku und Speicherkarte)
Betriebstemperatur	0 - 40 °C
Luftfeuchtigkeit während des Betriebs	5 - 85%

DE-11

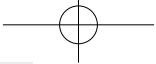

## Table des matieres



Informations relatives à la santé et à la sécurité .....	2	1
Présentation de l'appareil photo .....	4	15
Assemblage de votre appareil photo .....	5	14
Contenu du coffret .....	5	
Insertion de la batterie et de la carte mémoire .....	6	
Chargement de la batterie.....	6	
Mise en route de l'appareil photo .....	7	
Écran tactile .....	7	
Prise de vues photo ou vidéo .....	8	27
Lecture de fichiers .....	9	66
Transfert de fichiers vers un PC (Windows) .....	9	86
Utilisation des sites Web de partage de photos ou de vidéos.....	10	101
Caractéristiques .....	11	126

FR-2

## Informations relatives à la santé et à la sécurité



### Avertissements

#### N'utilisez pas l'appareil photo à proximité de gaz et de liquides inflammables ou explosifs

N'utilisez pas l'appareil à proximité de combustibles ou de produits chimiques inflammables. Ne transportez et ne stockez jamais de liquides inflammables, de gaz ou de matériaux explosifs dans le même emplacement que l'appareil ou ses accessoires.

#### Ne laissez pas l'appareil photo à la portée d'enfants en bas âge et d'animaux domestiques

Tenez l'appareil, ses pièces et ses accessoires, hors de portée des enfants en bas âge et des animaux. L'ingestion de petites pièces peut provoquer un étouffement ou des blessures graves. Les parties détachables et les accessoires représentent également un danger.

#### Évitez d'endommager la vue des sujets photographiés

N'utilisez pas le flash trop près (moins d'un mètre) des personnes et des animaux. L'utilisation du flash trop près des yeux du sujet peut provoquer des lésions temporaires ou permanentes.

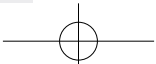
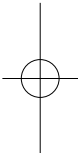

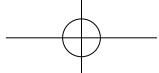

### Utilisez les batteries et les chargeurs avec précaution et respectez les consignes de recyclage

- Utilisez uniquement des batteries et des chargeurs Samsung. L'utilisation de batteries et de chargeurs incompatibles peut provoquer des blessures graves ou endommager votre appareil.
- Ne posez jamais les batteries ou l'appareil à l'intérieur ou au-dessus d'un dispositif chauffant, tel qu'un four à micro-ondes, une cuisinière ou un radiateur. En cas de surchauffe, les batteries risquent d'exploser.



#### Attention

### Manipulez et stockez votre appareil avec soins

- Évitez tout contact avec des liquides qui risqueraient d'endommager sérieusement votre appareil photo. N'utilisez pas l'appareil avec les mains mouillées. L'eau peut endommager votre appareil photo et entraîner l'annulation de la garantie du fabricant.
- Évitez d'utiliser et de stocker votre appareil dans un endroit poussiéreux, sale, humide ou mal ventilé afin de ne pas endommager ses composants internes.
- Lors du branchement des cordons et du chargeur et de l'insertion des batteries et des cartes mémoire, agissez prudemment. Enfoncer les cordons avec force ou sans précaution et insérer les batteries et les cartes mémoire de manière incorrecte peut endommager les prises et les accessoires.

- N'introduisez pas de corps étrangers dans les compartiments, les logements ou les ouvertures de l'appareil photo. Les dysfonctionnements qui s'en suivraient ne seront pas couverts par votre garantie.

### Protégez les batteries, les chargeurs et les cartes mémoire

- Évitez d'exposer les batteries et les cartes mémoire à des températures extrêmes (inférieures à 0 °C / 32 °F ou supérieures à 40 °C / 104 °F). Les températures extrêmes peuvent réduire les capacités de chargement des batteries et provoquer des dysfonctionnements des cartes mémoire.
- Évitez que les cartes mémoire ou l'emplacement pour carte mémoire n'entrent en contact avec des liquides, des poussières ou tout corps étranger. Cela risquerait d'endommager l'appareil photo ou les cartes mémoire.
- N'utilisez pas de carte mémoire qui a été formatée sur un autre appareil photo ou sur un ordinateur. Reformatez la carte mémoire sur votre appareil photo.

### Observez toutes les mises en garde et les consignes de sécurité

Respectez la réglementation interdisant l'utilisation des appareils photo dans certaines zones spécifiques.

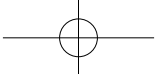

## Présentation de l'appareil photo

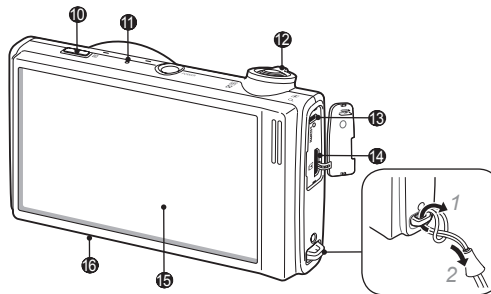
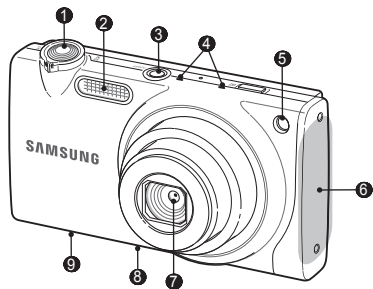

- |   |   |
|---|---|
| ❶ | Déclencheur                             |
| ❷ | Flash                                   |
| ❸ | Interrupteur Marche/Arrêt               |
| ❹ | Microphone                              |
| ❺ | Capteur Autofocus/Voyant du retardateur |
| ❻ | Antenne interne                         |
| ❼ | Objectif                                |
| ❽ | Haut-parleur                            |
| ❾ | Trappe batterie                         |

- |   |   |
|---|---|
| ❿ | Touche Lecture  |
| ⓫ | Voyant Indicateur   |
| ⓬ | Touche zoom   |
| ⓭ | Port HDMI (Compatible avec les câbles HDMI)   |
| ⓮ | Port USB et port Audio/Vidéo (Compatible avec un câble USB ou un câble Audio/Vidéo) |
| ⓯ | Écran tactile   |
| ⓰ | Fixation du pied  |

FR-4

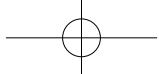

# Assemblage de votre appareil photo

## Contenu du coffret



Appareil photo



Adaptateur secteur/  
câble USB



Batterie rechargeable



Dragonne



Manuel de démarrage  
rapide

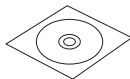

Mode d'emploi  
(CD-ROM)

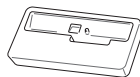

Station d'accueil

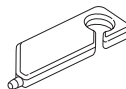

Styllet

## Accessoires en option



Étui de l'appareil  
photo



Carte mémoire  
(microSD™)

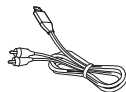

Câble Audio/  
Vidéo

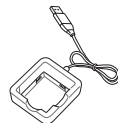

Chargeur de batterie

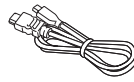

Câble HDMI

Français

FR-5

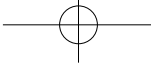

## Assemblage de votre appareil photo

### Insertion de la batterie et de la carte mémoire

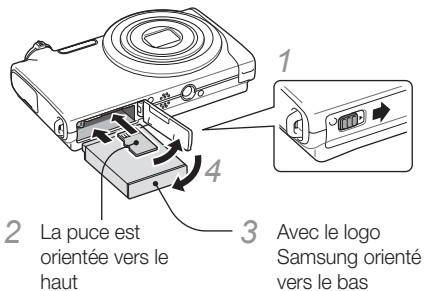

#### ▼ Retrait de la batterie

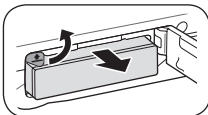

#### ▼ Retrait de la carte mémoire

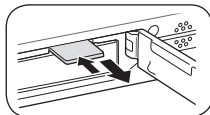

Poussez doucement jusqu'à faire sortir la carte de son logement, puis retirez-la entièrement.

FR-6



### Chargement de la batterie

Assurez-vous de charger la batterie avant d'utiliser l'appareil photo.

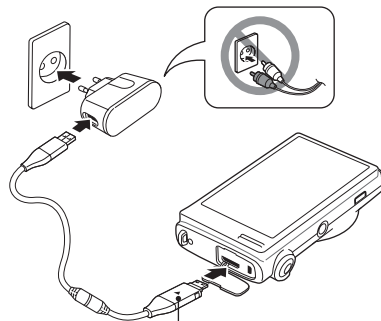

#### Voyant lumineux

- Rouge : Chargement
- Vert : Chargement terminé

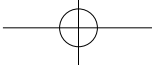

## Mise en route de l'appareil photo

- Appuyez sur l'interrupteur marche/arrêt pour allumer ou éteindre l'appareil photo.
  - L'écran de configuration initiale s'affiche lorsque vous allumez votre appareil photo pour la première fois.

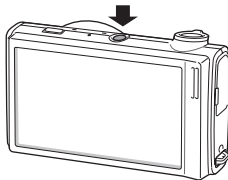

- Sélectionnez une langue, réglez la date et l'heure, choisissez un fuseau horaire et calibrez l'écran.

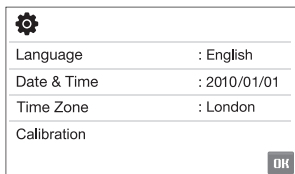

## Écran tactile

Utilisez le stylet fourni pour toucher l'écran ou faire défiler les options.



### Attention

N'utilisez pas d'objets pointus tels que des crayons ou des stylos pour toucher l'écran. Vous risqueriez d'endommager l'écran.

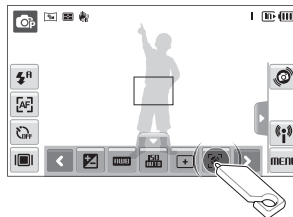

### Appuyer

Appuyez sur une icône pour ouvrir un menu ou régler une option.

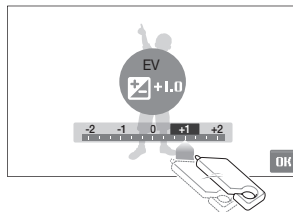

### Faire glisser

Faites glisser vers la gauche ou vers la droite pour un défilement horizontal.

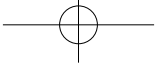

## Prise de vues photo ou vidéo

### Prendre une photo

- 1 L'appareil photo doit être en mode (Auto).
- 2 Cadrez le sujet à photographier.
- 3 Appuyez à mi-chemin sur le déclencheur pour une mise au point automatique.
  - Un cadre vert signifie que le sujet est mis au point.

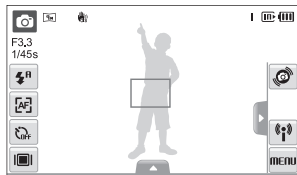

- 4 Appuyez à fond sur le déclencheur pour prendre la photo.

### Filmer une séquence vidéo

- 1 Sélectionnez → .
- 2 Cadrez le sujet à photographier.
- 3 Appuyez sur le déclencheur.
  - Pour interrompre l'enregistrement, sélectionnez .
  - Pour reprendre l'enregistrement, sélectionnez .
- 4 Appuyez à nouveau sur le déclencheur pour arrêter l'enregistrement.

### Remarque

#### Nombre de photos en fonction de la résolution

(pour une carte microSD™ de 1 Go)

	Résolution	Maximale	Élevée	Normale
<b>Hi</b>	4320 X 3240	122	240	353
<b>FH</b>	4000 X 3000	142	278	409
<b>1080</b>	3984 X 2656	160	312	454
<b>720</b>	3840 X 2160	206	401	588
<b>BH</b>	3264 X 2448	211	409	594
<b>5M</b>	2560 X 1920	335	637	908
<b>3M</b>	2048 X 1536	510	936	1 314
<b>2M</b>	1920 X 1080	762	1 373	1 931
<b>L</b>	1024 X 768	1 626	2 575	3 090

Ces chiffres proviennent des mesures effectuées par Samsung dans des conditions normales. Ils peuvent varier en fonction des paramètres et des conditions de prise de vue.

FR-8



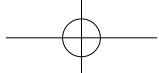

## Lecture de fichiers

### Visionner des photos

- 1 Appuyez sur [**Lecture**].
- 2 Dessinez un trait vers la gauche ou la droite, ou sélectionnez ◀ ou ▶ pour faire défiler les photos.
  - Vous pouvez également afficher des fichiers en faisant pivoter l'appareil photo.

### Afficher des vidéos

- 1 Appuyez sur [**Lecture**] et sélectionnez ▶.
- 2 Utilisez les icônes suivantes pour contrôler la lecture.

	Retour arrière
	Mettre en pause ou reprendre après une pause
	Arrêter la lecture
	Avance rapide
	Régler le volume ou désactiver le son

## Transfert de fichiers vers un PC (Windows)

- 1 Branchez l'appareil photo à l'ordinateur à l'aide du câble USB.

### Remarque

Vérifiez que l'option **Logiciel PC** est réglée sur **Marche** dans le menu des paramètres.

- 2 Allumez l'appareil photo.
  - L'ordinateur reconnaît l'appareil photo automatiquement.
  - Pour Windows Vista, sélectionnez **Run iStudio.exe** dans la fenêtre AutoPlay.
- 3 Sélectionnez un dossier sur votre ordinateur dans lequel vous allez enregistrer les nouveaux fichiers.
  - Si votre appareil photo est vide, la fenêtre de sauvegarde n'apparaîtra pas.
- 4 Sélectionnez **Oui**.
  - Les nouveaux fichiers seront transférés sur votre ordinateur. Vous pouvez à présent utiliser le programme Intelli-studio.

### Remarque

#### À propos d'Intelli-studio

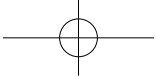

Intelli-studio est un programme intégré qui vous permet de lire et de modifier des fichiers. Ce logiciel vous permet également de télécharger des fichiers vers des sites Web tels que Flickr ou YouTube.

FR-9



## Utilisation des sites Web de partage de photos ou de vidéos

### Accéder à un site Web

- 1 En mode Prise de vue ou Lecture, sélectionnez  → .
  - L'appareil photo recherche et affiche les points d'accès wifi disponibles.
- 2 Sélectionnez un point d'accès wifi disponible.
  - L'appareil photo se connecte au réseau WLAN.
  - Si le point d'accès sélectionné requiert un mot de passe, saisissez-le.
  - Si l'appareil photo n'arrive pas à se connecter automatiquement au réseau WLAN, connectez-le manuellement. Pour plus d'informations sur la connexion au réseau WLAN, contactez votre administrateur réseau ou votre fournisseur d'accès Internet.
- 3 Sélectionnez un site Web.
- 4 Saisissez votre ID de connexion et votre mot de passe, puis sélectionnez **Identifiant**.

### Charger des photos ou des vidéos

- 1 Sélectionnez .
- 2 Sélectionnez  ou  pour faire défiler les fichiers.
- 3 Faites glisser les photos ou les vidéos dans la zone de sélection ou sélectionnez des photos ou des vidéos, et sélectionnez **OK**.

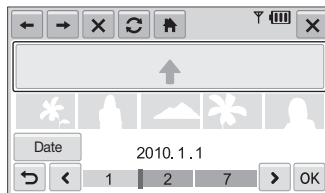

- Sélectionnez **Date** pour classer les fichiers par catégories.
- 4 Saisissez un titre et choisissez un album, puis sélectionnez .

### Remarque

- La vitesse de votre connexion Internet peut avoir une incidence sur le temps de chargement des photos ou d'ouverture des pages Web.
- L'envoi peut échouer en raison de la connexion réseau ou de paramètres du compte courriel.

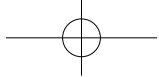

## Caractéristiques

Capteur d'images	<ul style="list-style-type: none"><li>Type : CCD 1/2.3" (environ 7,76 mm)</li><li>Pixels effectifs : environ 14,2 mégapixels</li><li>Nombre total de pixels : environ 14,5 mégapixels</li></ul>
Objectif	<ul style="list-style-type: none"><li>Distance focale : Objectif Schneider-KREUZNACH f = 5,6 - 39,2 mm (équivalent à un film 35 mm : 31 - 217 mm)</li><li>Plage d'ouverture de l'objectif : F3,3 (W) - F5,5 (T)</li></ul>
Écran	3,7" (9,4 cm) grand format avec écran tactile complet
Mise au point	Mise au point auto TTL (Mise au point multiple, Mise au point au centre, MAP Reconnaissance des visages, MAP détect. visage, Mise au point tactile intelligente, Prise de vue 1 touche)
Vitesse d'obturation	<ul style="list-style-type: none"><li>Automatique : 1/8 - 1/2 000 s.</li><li>Programme : 1 - 1/2 000 s.</li><li>Nuit : 8 - 1/2 000 s.</li><li>Feux d'artifice : 2 s.</li></ul>
Stockage	<ul style="list-style-type: none"><li>Mémoire interne : environ 13 Mo</li><li>Mémoire externe (en option) : Carte microSD™ (jusqu'à 4 Go garantis)</li></ul> La capacité de la mémoire interne peut varier par rapport à ces caractéristiques.
Connecteur d'alimentation CC	20 broches, 4,4 V
Batterie rechargeable	Batterie lithium-ion SLB-11A (1 130 mAh)
Dimensions (l x h x p)	103,8 x 58,3 x 19,6 mm
Poids	161,1 g (sans la batterie ni la carte mémoire)
Température de fonctionnement	0 - 40°C
Humidité	5 - 85%

FR-11

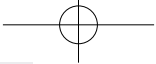

## Contenido

Información sobre salud y seguridad .....	2	1
Diseño de la cámara .....	4	15
Configuración de la cámara .....	5	14
Desembalaje .....	5	
Insertar la batería y la tarjeta de memoria .....	6	
Cargar la batería.....	6	
Encender la cámara .....	7	
Usar la pantalla táctil .....	7	
Captura de fotografías o vídeos.....	8	27
Reproducción de archivos ...	9	66
Transferencia de archivos a un ordenador (para Windows) ...	9	86
Uso de sitios web para compartir fotos o vídeos .....	10	101
Especificaciones .....	11	126



## Información sobre salud y seguridad



### Advertencias

#### No utilice la cámara cerca de líquidos y gases explosivos o inflamables

No utilice la cámara cerca de carburantes, combustibles o sustancias químicas inflamables. No almacene ni transporte líquidos inflamables, gases o materiales explosivos en el mismo compartimento en el que están la cámara o los accesorios.

#### Mantenga la cámara alejada del alcance de los niños y las mascotas

Mantenga la cámara y todos los accesorios fuera del alcance de los niños y los animales. Es posible que se traguen las piezas más pequeñas y, como consecuencia, se asfixien o sufran graves lesiones. Los accesorios y las piezas móviles también pueden causar daños físicos.

#### Evite dañar la vista del sujeto

No utilice el flash si está a una proximidad inferior a 1m de las personas o los animales. Si utiliza el flash cuando está demasiado cerca de los ojos del sujeto, puede producirle daños temporales o permanentes.

ES-2

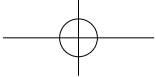

### Utilice y deseche las baterías y los cargadores con cuidado

- Utilice únicamente baterías y cargadores aprobados por Samsung. Las baterías y los cargadores incompatibles pueden producirle graves lesiones o causar daños a la cámara.
- Nunca coloque las baterías o las cámaras dentro de dispositivos conductores de calor, como hornos de microondas, estufas o radiadores, ni sobre ellos. Las baterías pueden explotar si se recalientan.



### Precauciones

### Utilice y guarde la cámara con cuidado y de manera prudente

- No permita que la cámara se moje, ya que los líquidos pueden causarle graves daños. No manipule la cámara si tiene las manos mojadas. Si se producen daños en la cámara a causa del agua, se puede anular la garantía del fabricante.
- No utilice ni guarde la cámara en áreas en las que haya polvo, suciedad, humedad o poca ventilación, a fin de evitar daños en las partes móviles o en los componentes internos.

- Tenga cuidado al conectar los cables y los adaptadores y al instalar las baterías y las tarjetas de memoria. Si ejerce demasiada fuerza sobre los conectores, conecta de manera inapropiada los cables o instala de manera inadecuada las baterías y las tarjetas de memoria, puede dañar los puertos, los conectores y los accesorios.
- No inserte objetos extraños en ningún compartimento, ranura o punto de acceso de la cámara. Es posible que la garantía no cubra este tipo de daños.

### Proteja las baterías, los cargadores y las tarjetas de memoria contra daños

- No exponga las baterías o las tarjetas de memoria a temperaturas demasiado bajas o demasiado altas (inferiores a 0 °C/32 °F o superiores a 40 °C/104 °F). Las temperaturas extremas pueden reducir la capacidad de carga de las baterías y generar un funcionamiento defectuoso de las tarjetas de memoria.
- No permita que líquidos, suciedad o sustancias extrañas entren en contacto con las tarjetas de memoria o la ranura de la tarjeta de memoria. Esto podría afectar el funcionamiento de las tarjetas de memoria o la cámara.
- No utilice tarjetas de memoria formateadas en otras cámaras u otros ordenadores. Vuelva a formatear la tarjeta de memoria con la cámara.

### Obedezca todas las normas y advertencias de seguridad

Cumpla con las normas que limitan el uso de la cámara en ciertas áreas.

ES-3

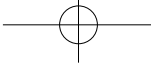

## Diseño de la cámara

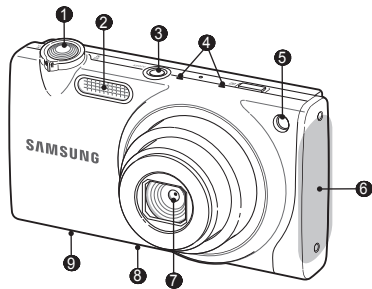

- |   |                                     |
|---|-------------------------------------|
| 1 | Botón del obturador                 |
| 2 | Flash                               |
| 3 | Botón de encendido y apagado        |
| 4 | Micrófono                           |
| 5 | Luz AF auxiliar/luz de temporizador |
| 6 | Antena interna                      |
| 7 | Lente                               |
| 8 | Altavoz                             |
| 9 | Cubierta de la cámara de la batería |

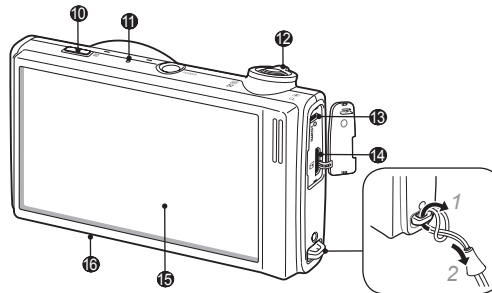

- |    |   |
|----|---|
| 10 | Botón de playback                               |
| 11 | Luz indicadora de estado                        |
| 12 | Botón de zoom                                   |
| 13 | Puerto HDMI (Admite cable HDMI)                 |
| 14 | Puerto USB y A/V (Admite cable USB y cable A/V) |
| 15 | Pantalla táctil                                 |
| 16 | Orificio para el montaje del trípode            |

ES-4



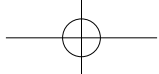

# Configuración de la cámara

## Desembalaje

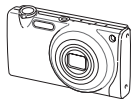

Cámara



Fuente de alimentación/  
Cable USB



Batería recargable



Correa



Manual de inicio rápido

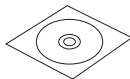

CD-ROM del Manual  
del usuario

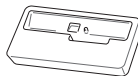

Soporte

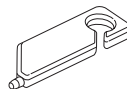

Puntero

## Accesorios opcionales



Estuche para la  
cámara



Tarjeta de memoria  
(microSD™)

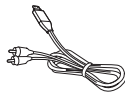

Cable A/V



Cargador de la  
batería

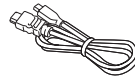

Cable HDMI

Español

ES-5

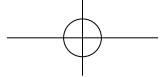

## Configuración de la cámara

### Insertar la batería y la tarjeta de memoria

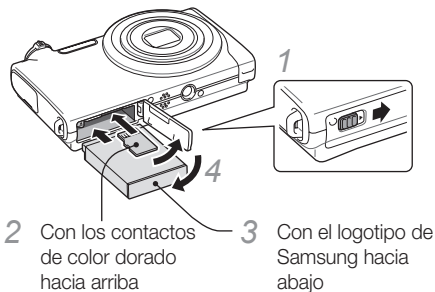

#### ▼ Quitar la batería

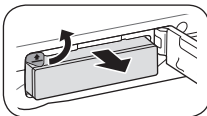

#### ▼ Quitar la tarjeta de memoria

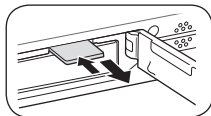

Ejercer una leve presión hasta que la tarjeta se desprenda de la cámara y, luego, retírela de la ranura.

ES-6

### Cargar la batería

Cargue la batería antes de utilizar la cámara.

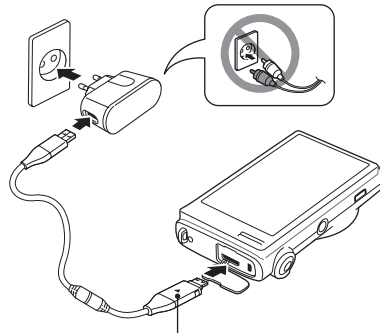

#### Luz indicadora

- Rojo: cargándose
- Verde: completamente cargada

Utilice sólo fuente de alimentación con las siguientes características eléctricas y que estén debidamente certificados de acuerdo a la legislación vigente. El uso de otras fuentes de alimentación podría dañar el dispositivo y anular la garantía además de provocar riesgos al usuario.

- Características de entrada: CA 100-240V, 50/60HZ, 0.2A, CLASE II
- Características de salida: CC 4.4V, 0.4 A



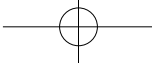

## Encender la cámara

- 1 Pulse **[POWER]** para encender o apagar la cámara.
  - Cuando encienda la cámara por primera vez, aparecerá la pantalla de configuración inicial.

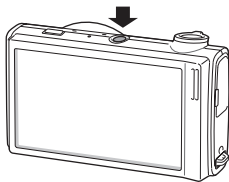

- 2 Seleccione el idioma, establezca la fecha y la hora, seleccione un huso horario y calibre la pantalla.

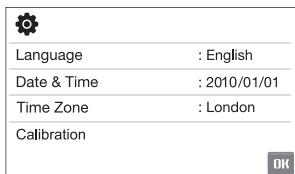

## Usar la pantalla táctil

Utilice el puntero proporcionado para tocar la pantalla o arrastrar algún elemento sobre ella.



### Precaución

No utilice objetos puntiagudos como lápices o portaminas para tocar la pantalla. Esto podría dañarla.

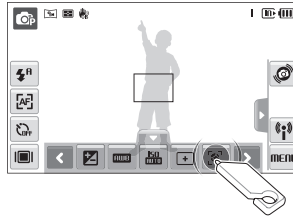

### Tocar

Toque un icono para abrir un menú o para ajustar una opción.

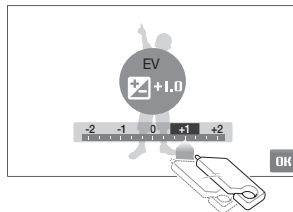

### Arrastrar

Arrastre el dedo hacia la izquierda o hacia la derecha para desplazarse de forma horizontal.

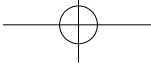

# Captura de fotografías o vídeos

## Tomar una fotografía

- 1 Asegúrese de que la cámara esté en (modo Auto).
- 2 Alinee el sujeto en el marco.
- 3 Pulse **[Obturador]** hasta la mitad para utilizar el enfoque automático.
  - Si aparece un cuadro verde, significa que el sujeto está enfocado.

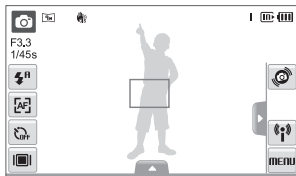

- 4 Pulse **[Obturador]** completamente para tomar la fotografía.

## Grabar un vídeo

- 1 Seleccione → .
- 2 Alinee el sujeto en el marco.
- 3 Pulse **[Obturador]**.
  - Para pausar, seleccione **[II]**.
  - Para reanudar, seleccione **[●]**.
- 4 Pulse **[Obturador]** nuevamente para detener la grabación.

### + Nota

#### Cantidad de fotografías por resolución (para microSD™ de 1 GB)

Resolución	Superfina	Fina	Normal
<b>Hi</b> 4320 X 3240	122	240	353
<b>Hi</b> 4000 X 3000	142	278	409
<b>1080</b> 3984 X 2856	160	312	454
<b>720</b> 3840 X 2160	206	401	588
<b>6M</b> 3264 X 2448	211	409	594
<b>5M</b> 2560 X 1920	335	637	908
<b>3M</b> 2048 X 1536	510	936	1314
<b>2M</b> 1920 X 1080	762	1373	1931
<b>1M</b> 1024 X 768	1626	2575	3090

Estas son medidas tomadas en condiciones estándar, establecidas por Samsung, y pueden variar según las condiciones de disparo y la configuración de la cámara.

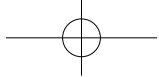

## Reproducción de archivos

### Ver fotografías

- 1 Pulse **[Playback]**.
- 2 Dibuje una barra horizontal hacia la izquierda o la derecha, o seleccione **◀** o **▶** para desplazarse por las fotografías.
  - También puede inclinar la cámara a fin de ver los archivos.

### Ver vídeos

- 1 Pulse **[Playback]** y seleccione **▶**.
- 2 Use los siguientes iconos para controlar la reproducción.

	Permite retroceder.
	Permite pausar o reanudar la reproducción.
	Permite detener la reproducción.
	Permite avanzar.
	Permite ajustar el volumen o silenciar los sonidos.

## Transferencia de archivos a un ordenador (para Windows)

- 1 Conecte la cámara a su ordenador con el cable USB.

### Nota

Asegúrese de que la opción **Software del PC** esté configurada en **Encendido** en el menú de ajustes.

- 2 Encienda la cámara.
  - El ordenador reconoce la cámara automáticamente.
  - En Windows Vista, seleccione **Run iStudio.exe** en la ventana Reproducción automática
- 3 Seleccione una carpeta en el ordenador para guardar los archivos nuevos.
  - Si su cámara no tiene archivos nuevos, no aparecerá la ventana emergente para guardar nuevos archivos.
- 4 Seleccione **Sí**.
  - Los archivos nuevos se transferirán al ordenador. Ahora puede utilizar el programa Intelli-studio.

### Nota

#### Sobre Intelli-studio

Intelli-studio es un programa incorporado que le permite reproducir y editar archivos. Además, puede cargar archivos en sitios web, como Flickr o YouTube.

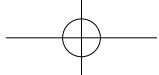

## Uso de sitios web para compartir fotos o vídeos

### Acceso a un sitio web

- 1 En el modo de disparo o de reproducción, seleccione → .
  - La cámara busca y muestra los dispositivos AP disponibles.
- 2 Seleccione un dispositivo AP.
  - La cámara se conecta a la WLAN.
  - Si el dispositivo AP seleccionado requiere una contraseña, introduzca una.
  - Si la cámara no puede conectarse a la WLAN automáticamente, conéctela manualmente. Para obtener más información sobre cómo realizar la conexión a la WLAN, póngase en contacto con el administrador de la red o con el proveedor de servicios de red.
- 3 Seleccione un sitio web.
- 4 Introduzca su ID de registro y contraseña, y seleccione **Login**.

### Uploading photos or videos

- 1 Seleccione .
- 2 Seleccione o para desplazarse por los archivos.
- 3 Arrastre fotos o vídeos al área de selección o seleccione fotografías o vídeos y, a continuación, seleccione **OK**.

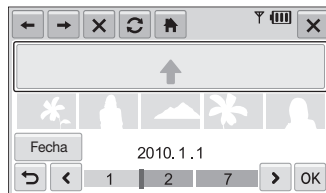

- Seleccione **Fecha** para clasificar los archivos.
- 4 Introduzca un título y seleccione un álbum. Luego, seleccione .

### Nota

- La velocidad de la conexión a Internet podría afectar la velocidad en que se carguen las fotografías o se abran las páginas web.
- Es posible que no pueda enviar un correo electrónico debido a la conexión de red o a la configuración de la cuenta de correo electrónico.

ES-10

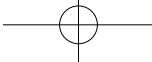

## Especificaciones

Sensor de imagen	<ul style="list-style-type: none"><li>• Tipo: 1/2,3" (aprox. 7,76 mm) CCD</li><li>• Píxeles reales: aprox. 14,2 megapíxeles</li><li>• Píxeles totales: aprox. 14,5 megapíxeles</li></ul>
Lente	<ul style="list-style-type: none"><li>• Distancia focal: lente Schneider-KREUZNACH f = de 5,6 a 39,2 mm (equivalente en película de 35 mm: de 31 a 217 mm)</li><li>• Rango de apertura del objetivo: F3,3 (W) y F5,5 (T)</li></ul>
Pantalla	Panel completo de pantalla táctil ancha de 9,4 cm (3,7")
Enfoque	Enfoque automático TTL (Multi af, Af central, AF de reconocimiento de rostros, AF de detección de rostros, AF táctil inteligente, Disparo con un toque)
Velocidad del obturador	<ul style="list-style-type: none"><li>• Auto: de 1/8 a 1/2000 s</li><li>• Programa: de 1 a 1/2000 s</li><li>• Nocturno: de 8 a 1/2000 s</li><li>• Fuegos Artificiales: 2 s</li></ul>
Almacenamiento	<ul style="list-style-type: none"><li>• Memoria interna: aprox. 13 MB</li><li>• Memoria externa (opcional): Tarjeta microSD™ (hasta 4 GB garantizados)</li></ul> <p>Es posible que la capacidad de la memoria interna no coincida con estas especificaciones.</p>
Conector de entrada de CC	20 pines, 4,4 V
Batería recargable	Batería de litio (SLB-11A, 1130 mAh)
Dimensiones (alto x ancho x profundidad)	103,8 x 58,3 x 19,6 mm
Peso	161,1 g (sin la batería ni la tarjeta de memoria)
Temperatura de funcionamiento	De 0 °C a 40 °C
Humedad de funcionamiento	De 5 a 85%

Español

ES-11

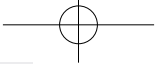

## Contenuto

Informazioni sulla salute e la sicurezza .....	2	1
Layout fotocamera .....	4	15
Preparazione della fotocamera .....	5	14
Apertura dell'imballaggio .....	5	
Inserimento della batteria e della scheda di memoria .....	6	
Come caricare la batteria .....	6	
Come accendere la fotocamera	7	
Utilizzo dello schermo tattile .....	7	
Cattura di foto o video .....	8	27
Riproduzione di file .....	9	66
Trasferimento di file ad un PC (Windows) .....	9	86
Utilizzo di siti Web per la condivisione di foto o video	10	101
Specifiche .....	11	126



## Informazioni sulla salute e la sicurezza



### Avvertimenti

#### Non utilizzate la fotocamera in prossimità di gas e liquidi infiammabili o esplosivi

Non utilizzare la fotocamera vicino a carburanti, combustibili o altre sostanze chimiche infiammabili. Non conservare o non trasportare liquidi infiammabili, gas o esplosivi nello stesso scomparto in cui si trova la fotocamera o i relativi accessori.

#### Tenete la fotocamera lontano da bambini e piccoli animali

Tenete la fotocamera e tutti gli accessori fuori dalla portata di bambini piccoli e animali. Se ingoiate, le parti piccole possono provocare soffocamento o gravi lesioni. Anche le parti e accessori mobili possono rappresentare un pericolo fisico.

#### Come prevenire lesioni alla vista del soggetto

Non usare il flash molto vicino (più vicino di 1 m) a persone o animali. L'uso del flash vicino agli occhi del soggetto può provocare danni temporanei o permanenti.

IT-2

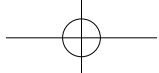

### Maneggiate e smaltite con cura le batterie e i caricabatterie

- Utilizzare solo batterie e caricabatterie approvati da Samsung. Batterie e caricabatterie incompatibili possono provocare ferite o danni seri alla fotocamera.
- Non posizionate mai batterie o fotocamere sopra o all'interno di dispositivi di riscaldamento come microonde, forni o radiatori. Le batterie surriscaldate rischiano di esplodere.



#### Attenzione

### Maneggiare e smaltire la fotocamera con attenzione e delicatezza

- Evitare che sulla fotocamera vengano versati liquidi poiché ciò può provocare danni seri. Non maneggiare la fotocamera con le mani bagnate. Eventuali danni provocati dall'acqua alla fotocamera possono invalidare la garanzia del produttore.
- Evitare di utilizzare o di conservare la fotocamera in aree polverose, sporche, umide o poco ventilate per evitare danni alle parti mobili e ai componenti interni.
- Far attenzione quando si collegano i cavi o adattatori e quando si installano le batterie e schede di memoria.

Forzando i connettori, collegando i cavi in modo incorretto o installando le batterie e le schede di memoria non secondo la norma, si rischia di causare danni alle porte, ai connettori e agli accessori.

- Non inserite oggetti estranei negli scomparti, slot o punti di accesso della fotocamera. Questo tipo di danno non è coperto dalla garanzia.

### Proteggere le batterie, i caricabatteria e le schede di memoria da eventuali danni

- Non esporre le batterie o schede di memoria a temperature estremamente fredde o calde (al di sotto di 0° C/32° F o al di sopra di 40° C/104° F). Le temperature estreme possono ridurre la capacità di carica delle batterie e causare malfunzionamento delle schede di memoria.
- Evitate che liquidi, sporco o sostanze estranee entrino in contatto con le schede di memoria o le fessure per schede di memoria. In caso contrario si rischia di danneggiare le schede di memoria o la fotocamera.
- Non utilizzate schede di memoria formattate da altre fotocamere o computer. Riformattate la scheda di memoria con la fotocamera.

### Rispettate le seguenti avvertenze e normative di sicurezza

Attenetevi alle normative relative all'uso di una fotocamera in un'area particolare.

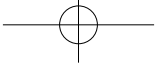

## Layout fotocamera

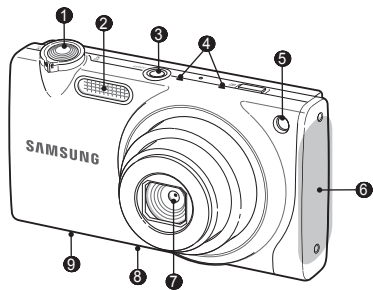

- 1 Tasto [Otturatore] o meglio definito tasto di scatto
- 2 Flash
- 3 Tasto di accensione
- 4 Microfono
- 5 Luce AF/spia timer
- 6 Antenna interna
- 7 Obiettivo
- 8 Altoparlante
- 9 Coperchio della batteria

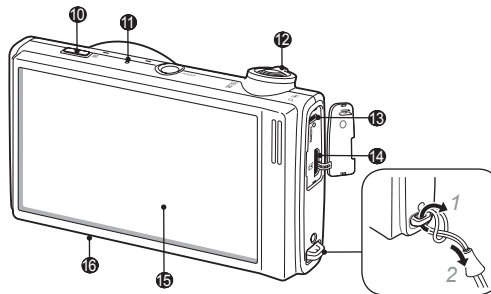

- 10 Tasto riproduzione
- 11 Spia di stato
- 12 Tasto zoom
- 13 Porta HDMI (Accetta il cavo HDMI)
- 14 Porta USB e AV (Accetta il cavo USB o il cavo AV)
- 15 Schermo tattile
- 16 Attacco del cavalletto

IT-4



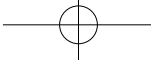

# Preparazione della fotocamera

## Apertura dell'imballaggio



Fotocamera



Adattatore AC/  
cavo USB



Batteria ricaricabile



Cinturino



Guida rapida

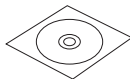

Manuale dell'utente  
CD-ROM

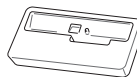

Supporto

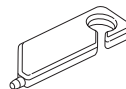

Penna tattile

### Accessori opzionali



Custodia  
fotocamera



Scheda di memoria  
(microSD™)

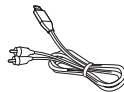

Cavo A/V

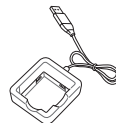

Caricatore della  
batteria

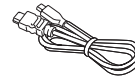

Cavo HDMI



Italiano

IT-5

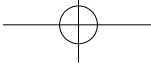

## Preparazione della fotocamera

### Inserimento della batteria e della scheda di memoria

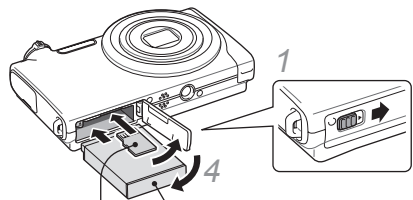

2 Con i contatti dorati rivolti verso l'alto

3 Con il logo Samsung rivolto verso il basso

▼ Come rimuovere la batteria

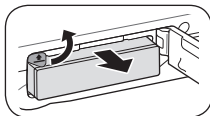

▼ Come rimuovere la scheda di memoria

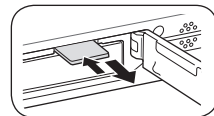

Spingete la scheda con delicatezza in modo da liberarla dalla fotocamera, quindi estraetela dallo slot.

IT-6

### Come caricare la batteria

Assicurarsi di aver ricaricato la batteria prima di utilizzare la fotocamera.

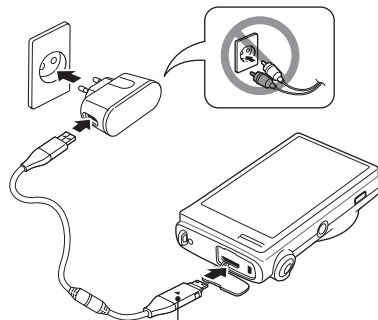

Spia indicatrice

- Rosso: Carica
- Verde: Carica completa

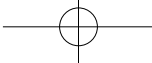

## Come accendere la fotocamera

- 1 Premete **[POWER]** per accendere o spegnere la fotocamera.
  - Compare la schermata iniziale di installazione all'accensione della fotocamera per la prima volta.

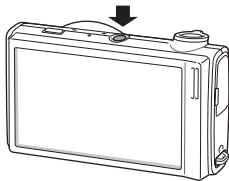

- 2 Seleziona una lingua, definisce la data e l'ora, imposta il fuso orario e calibra lo schermo.

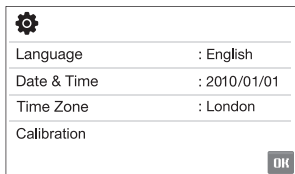

## Utilizzo dello schermo tattile

Utilizzate la penna touch fornita per toccare o spostarsi sullo schermo.



### Attenzione

Non utilizzate altri oggetti appuntiti, come penne o matite, per toccare lo schermo. In caso contrario si rischia di danneggiare lo schermo.

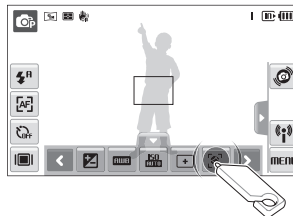

### Toccando

Tocate un'icona per aprire un menu o per impostare un'opzione.

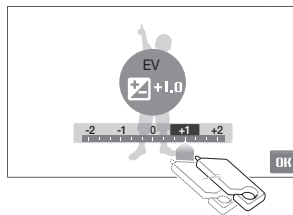

### Trascinando

Trascinate a sinistra o a destra per scorrere in orizzontale.

Italiano

IT-7

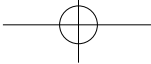

## Cattura di foto o video

### Scattare una foto

- 1 Assicuratevi che la fotocamera sia in modalità (modalità automatica).
- 2 Allineate il soggetto al riquadro.
- 3 Premete parzialmente **[Otturatore]** per eseguire la messa a fuoco automatica.
  - Un riquadro verde indica che il soggetto è messo a fuoco.

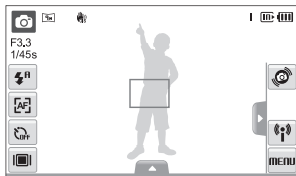

- 4 Premete completamente **[Otturatore]** per scattare una foto.

### Registrazione di un video

- 1 Selezionate → .
- 2 Allineate il soggetto al riquadro.
- 3 Premete **[Otturatore]**.
  - Per effettuare una pausa, selezionate **II**.
  - Per riprendere, selezionate **●**.
- 4 Premete **[Otturatore]** per arrestare la registrazione.

### \* Nota

Numero di foto per risoluzione (per micro SD™ da 1 GB)

	Risoluzione	S. fine	Fine	Normale
<b>Hi</b>	4320 X 3240	122	240	353
<b>2H</b>	4000 X 3000	142	278	409
<b>10h</b>	3984 X 2656	160	312	454
<b>7h</b>	3840 X 2160	206	401	588
<b>8M</b>	3264 X 2448	211	409	594
<b>5M</b>	2560 X 1920	335	637	908
<b>3M</b>	2048 X 1536	510	936	1314
<b>2M</b>	1920 X 1080	762	1373	1931
<b>1M</b>	1024 X 768	1626	2575	3090

Questi valori sono misurati in condizioni standard Samsung e possono variare in base alle condizioni di scatto e alle impostazioni della fotocamera.

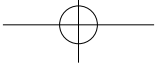

## Riproduzione di file

### Visualizzazione delle fotografie

- 1 Premete [**Riproduzione**].
- 2 Disegnate una barra orizzontale verso sinistra o destra o selezionate ◀ o ▶ per scorrere le fotografie.
  - Potete anche visualizzare i file inclinando la fotocamera.

### Visualizzazione dei video

- 1 Premete [**Riproduzione**] e selezionate ▶.
- 2 Per il controllo della riproduzione, utilizzate le icone seguenti.

◀◀	Cerca indietro
⏸	Mette in pausa o riprende la riproduzione
■	Interrompe la riproduzione
▶▶	Cerca avanti
🔊	Regola il volume o disattiva il suono

## Trasferimento di file ad un PC (Windows)

- 1 Collegate la fotocamera al computer con il cavo USB.

### Nota

Accertatevi che l'opzione **Software PC** sia impostata su **Si** nel menu impostazioni.

- 2 Accendete la fotocamera.
  - Il computer riconosce automaticamente la fotocamera.
  - Per Windows Vista, selezionate **Run iStudio.exe** dalla finestra AutoPlay.
- 3 Selezionate una cartella sul computer in cui salvare i nuovi file.
  - Se la fotocamera non presenta file, non comparirà la finestra a comparsa per il salvataggio di nuovi file.
- 4 Selezionate **Si**.
  - Saranno trasferiti nuovi file sul computer. Ora potete utilizzare il programma Intelli-studio.

### Nota

#### Informazioni su Intelli-studio

Intelli-studio è un programma integrato che consente di riprodurre e modificare file. Potete anche caricare file su siti Web, come Flickr o YouTube.



Italiano

IT-9

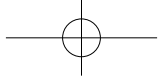

## Utilizzo di siti Web per la condivisione di foto o video

### Accesso ad un sito Web

- 1 Nella modalità di scatto o riproduzione, premete → .
  - La fotocamera effettuerà la ricerca e visualizzerà i dispositivi AP.
- 2 Selezionate un dispositivo AP.
  - La fotocamera si conatterà alla WLAN.
  - Se il dispositivo AP selezionato necessita di una password, inserite una password.
  - Se la fotocamera non riesce a connettersi automaticamente alla WLAN, connettersi manualmente. Per ulteriori informazioni sulla connessione alla WLAN, contattate l'amministratore di rete o il fornitore di servizi di rete.
- 3 Selezionate un sito Web.
- 4 Selezionate un sito Web **Login**.

### Caricare foto o video

- 1 Selezionate .
- 2 Selezionate o per scorrere tra i file.
- 3 Trascinate foto o video all'area di selezione e selezionate foto o video, quindi selezionate **OK**.

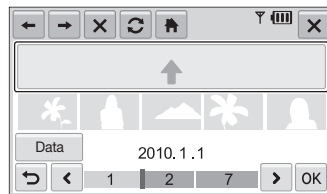

- Selezionate **Data** per classificare i file.
- 4 Inserite un titolo e selezionate un album, quindi selezionate .

### Nota

- La velocità della connessione Internet potrebbe influenzare il caricamento delle foto o l'apertura di pagine Web.
- Non potete inviare una e-mail a causa delle impostazioni della connessione di rete o dell'account dell'e-mail.

IT-10

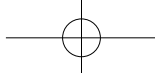

## Specifiche

Sensore immagini	<ul style="list-style-type: none"><li>• Tipo: 1/2,3" (ca. 7,76 mm) CCD</li><li>• Pixel effettivi: ca. 14,2 mega pixel,</li><li>• Pixel totali: ca. 14,5 mega pixel,</li></ul>
Obiettivo	<ul style="list-style-type: none"><li>• Lunghezza focale: Obiettivo Schneider - KREUZNACH f = 5,6 - 39,2 mm (equivalente per pellicola nel formato da 35 mm: 31 - 217 mm)</li><li>• Intervallo apertura diaframma: F3,3 (W) - F5,5 (T)</li></ul>
Display	3,7" (9,4 cm) largo con un pannello a schermo tattile intero
Messa a fuoco	AF TTL (Af multiplo, Af centrato, AF riconoscimento volto, AF rilevamento volto, Smart Touch AF, Ripresa one-touch)
Velocità otturatore	<ul style="list-style-type: none"><li>• Auto: 1/8 - 1/2000 sec.</li><li>• Programm.: 1 - 1/2000 sec.</li><li>• Notte: 8 - 1/2000 sec.</li><li>• Fuochi Art.: 2 sec.</li></ul>
Memoria	<ul style="list-style-type: none"><li>• Memoria interna: circa 13 MB</li><li>• Memoria esterna (opzionale): Scheda microSD™ (fino a 4 GB garantiti)</li></ul> <p>È possibile che la capacità della memoria interna non corrisponda a queste caratteristiche tecniche.</p>
Presa di ingresso alimentazione in CC	20 pin, 4,4 V
Batteria ricaricabile	Batteria agli ioni di litio (SLB-11A, 1130 mAh)
Dimensioni (L x A x P)	103,8 x 58,3 x 19,6 mm
Peso	161,1 g (senza batteria e scheda di memoria)
Temperatura di esercizio	0 - 40° C
Umidità di esercizio	5 - 85%

Italiano

IT-11

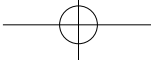

## Inhoudsopgave

Informatie over gezondheid en veiligheid .....	2	1
Camera-indeling .....	4	15
Uw camera gereedmaken voor gebruik .....	5	14
Uitpakken .....	5	
De batterij en geheugenkaart plaatsen .....	6	
De batterij opladen .....	6	
De camera inschakelen .....	7	
Het aanraakscherm gebruiken ...	7	
Foto's en video's maken .....	8	27
Bestanden afspelen .....	9	66
Bestanden overzetten naar een pc (Windows) .....	9	86
Websites voor het delen van foto's of video's gebruiken ...	10	101
Specificaties .....	11	126



NL-2

## Informatie over gezondheid en veiligheid



### Waarschuwingen

#### Gebruik de camera niet dichtbij ontvlambare of explosieve gassen en vloeistoffen

Gebruik de camera niet in de buurt van brandstoffen, brandbare stoffen of ontvlambare chemicaliën. Bewaar geen ontvlambare vloeistoffen, gassen en explosief materiaal in dezelfde ruimte als de camera of de accessoires van de camera.

#### Houd de camera buiten het bereik van kleine kinderen en huisdieren

Houd de camera en alle bijbehorende onderdelen en accessoires buiten het bereik van kleine kinderen en huisdieren. Kleine onderdelen vormen verstikkingsgevaar of kunnen schadelijk zijn wanneer zij worden ingeslikt. Bewegende onderdelen en accessoires kunnen ook fysiek gevaar opleveren.

#### Vorkom schade aan het gezichtsvermogen bij gefotografeerde personen of dieren

Gebruik de flitser van de camera niet vlakbij (op minder dan 1 meter afstand van) de ogen van mensen of dieren. Gebruik van de flitser dicht bij de ogen van mens of dier kan tot tijdelijke of permanente schade aan het gezichtsvermogen leiden.

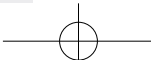
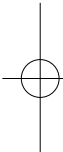



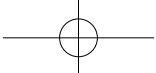

### Behandel batterijen en oplader voorzichtig en voer deze af volgens de voorschriften

- Gebruik alleen door Samsung goedgekeurde batterijen en opladers. Niet-compatibele batterijen en opladers kunnen ernstig letsel of schade aan de camera veroorzaken.
- Leg batterijen of camera's nooit in of op verwarmingsapparaten, zoals een magnetron, kachel of radiator. Batterijen kunnen exploderen als ze te heet worden.



### Voorzichtig

### De camera voorzichtig en verstandig behandelen en opslaan

- Zorg ervoor dat de camera niet nat wordt. Het toestel kan door vloeibare stoffen ernstig beschadigen. Raak de camera niet aan met natte handen. De garantie van de fabrikant is niet van toepassing op waterschade aan het toestel.
- Gebruik of bewaar de camera niet in stoffige, vuile, vochtige of slecht-geventileerde gebieden om schade aan bewegende en interne onderdelen te voorkomen.

- Wees voorzichtig bij het aansluiten van snoeren en adapters en het plaatsen van batterijen en geheugenkaarten. Door het forceren van aansluitingen, het niet op de juiste manier aansluiten van snoeren of het niet op de juiste manier plaatsen van batterijen en geheugenkaarten kunnen poorten, aansluitingen en accessoires beschadigd raken.
- Steek geen vreemde voorwerpen in de compartimenten, sleuven en openingen van de camera. Dit soort schade valt mogelijk niet onder de garantie.

### Bescherm batterijen, opladers en geheugenkaarten tegen schade

- Vermijd blootstelling van batterijen of geheugenkaarten aan zeer lage of zeer hoge temperaturen (onder 0° C/32° F of boven 40° C/104° F). Door extreme temperaturen kan de capaciteit van batterijen verminderen en kunnen geheugenkaarten minder goed werken.
- Voorkom dat geheugenkaarten, of de sleuf voor geheugenkaarten, in contact komen met vloeistoffen, vuil of vreemde stoffen. Dergelijke stoffen kunnen ervoor zorgen dat geheugenkaarten of de camera niet goed meer werken.
- Gebruik geen geheugenkaarten die in een andere camera of door een computer zijn geformatteerd. Formatteer een dergelijke geheugenkaart opnieuw in uw eigen camera.

### Volg alle veiligheidsvoorschriften en regelgeving op

Houd u aan alle regelgeving die het gebruik van camera's in bepaalde omgevingen beperkt.

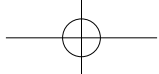

## Camera-indeling

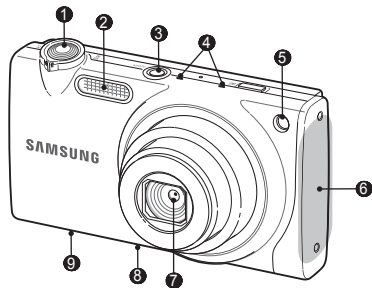

- 1 Ontspanknop
- 2 Flitser
- 3 Power-knop
- 4 Microfoon
- 5 AF-hulpknopje/timerlampje
- 6 Interne antenne
- 7 Lens
- 8 Luidspreker
- 9 Batterijklep

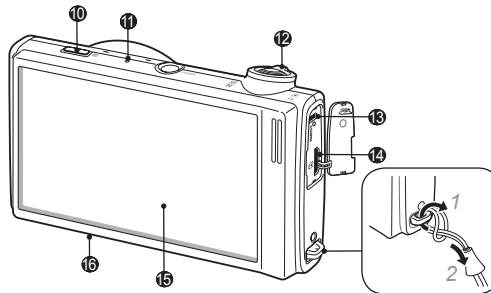

- 10 Weergaveknop
- 11 Statuslampje
- 12 Zoomknop
- 13 HDMI-aansluiting  
(Voor aansluiting van HDMI-kabel)
- 14 USB- en A/V-aansluiting  
(Voor aansluiting van USB- of A/V-kabel)
- 15 Aanraakscherm
- 16 Statiefbevestigingspunt

NL-4



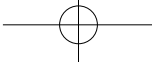

# Uw camera gereedmaken voor gebruik

## Uitpakken



Camera



AC-adapter/  
USB-kabel



Oplaadbare batterij



Polslus



Snelstartgids

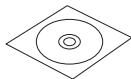

Gebruiksaanwijzing op  
cd-rom

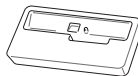

Houder

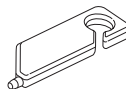

Schermen

## Optionele accessoires



Camera-etui



Geheugenkaart  
(microSD™)

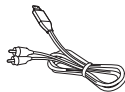

AV-kabel

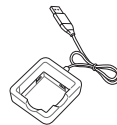

Batterijoplader

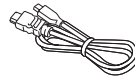

HDMI-kabel

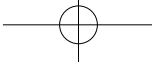

## Uw camera gereedmaken voor gebruik

### De batterij en geheugenkaart plaatsen ▶

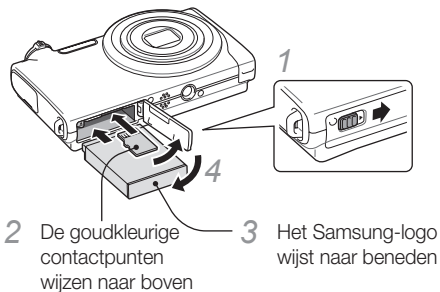

#### ▼ De batterij verwijderen

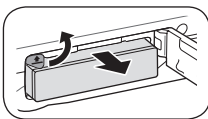

#### ▼ De geheugenkaart verwijderen

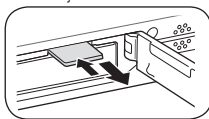

Duw voorzichtig tegen de kaart totdat deze loskomt uit de camera en trek de kaart vervolgens uit de sleuf.

NL-6

### De batterij opladen ▶

Zorg ervoor dat u de batterij oplaadt voordat u de camera gebruikt.

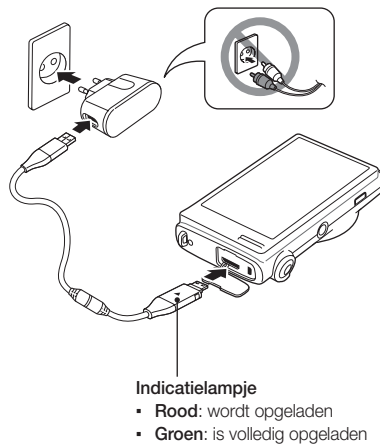

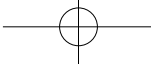

## De camera inschakelen

- 1 Druk op **[POWER]** om de camera in- of uit te schakelen.
  - Het scherm voor de eerste installatie verschijnt wanneer u de camera voor het eerst inschakelt.

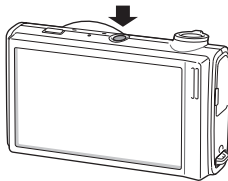

- 2 Selecteer een taal, stel de datum en tijd in, selecteer een tijdzone en kalibreer het scherm.

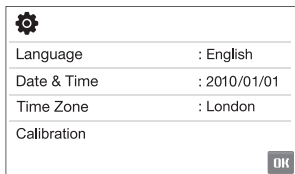

## Het aanraakscherm gebruiken

Gebruik de meegeleverde scherpenn om dingen op het scherm aan te raken of over het scherm te slepen.



Let op

Raak het scherm niet aan met scherpe voorwerpen zoals pennen en potloden. Hierdoor zou het scherm kunnen beschadigen.

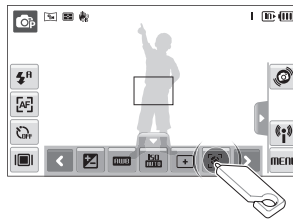

### Aanraken

Raak een symbool aan om een menu te openen of een optie in te stellen.

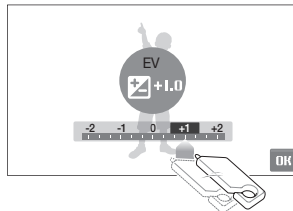

### Slepen

Sleep naar links of rechts om horizontaal te schuiven.

Nederlands

NL-7

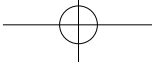

## Foto's en video's maken

### Een foto maken

- 1 Zorg dat de camera in de modus  (automatische modus) staat.
- 2 Kadreer het onderwerp.
- 3 Druk **[Ontspanknop]** half in om automatisch scherp te stellen.
  - Een groen kader betekent dat het onderwerp scherp in beeld is.

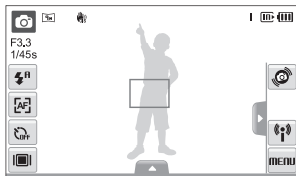

- 4 Druk **[Ontspanknop]** helemaal in om de foto te maken.

### Een video opnemen

- 1 Selecteer  → .
- 2 Kadreer het onderwerp.
- 3 Druk op **[Ontspanknop]**.
  - Om te pauzeren, selecteert u .
  - Om de opname te hervatten, selecteert u .
- 4 Druk nogmaals op **[Ontspanknop]** om de opname te stoppen.

### \* Opmerking

Aantal foto's per resolutie (voor microSD™ van 1 GB)

	Resolutie	Superhoog	Hoog	Normaal
<b>Hi</b>	4320 X 3240	122	240	353
<b>2H</b>	4000 X 3000	142	278	409
<b>10h</b>	3984 X 2656	160	312	454
<b>7h</b>	3840 X 2160	206	401	588
<b>8M</b>	3264 X 2448	211	409	594
<b>5M</b>	2560 X 1920	335	637	908
<b>3M</b>	2048 X 1536	510	936	1314
<b>2M</b>	1920 X 1080	762	1373	1931
<b>L</b>	1024 X 768	1626	2575	3090

Deze waarden zijn gemeten onder standaardcondities en kunnen variëren afhankelijk van opnameomstandigheden en camera-instellingen.

NL-8

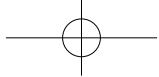

## Bestanden afspelen

### Foto's weergeven

- 1 Druk op **[Weergaveknop]**.
- 2 Teken een horizontale lijn naar links of rechts of selecteer **◀** of **▶** om door foto's te bladeren.
  - U kunt tevens bestanden bekijken door de camera te kantelen.

### Video's bekijken

- 1 Druk op **[Weergaveknop]** en selecteer **▶**.
- 2 Met de volgende symbolen kunt u het afspelen regelen.

	Achteruit spoelen
	Het afspelen onderbreken of hervatten
	Het afspelen stoppen
	Vooruit spoelen
	Het volume aanpassen of dempen

## Bestanden overzetten naar een pc (Windows)

- 1 Sluit de camera op de computer aan met de USB-kabel.

### Opmerking

Controleer of de optie **Pc-software** is ingesteld op **Aan** in het instellingenmenu.

- 2 Schakel de camera in.
  - De camera wordt automatisch herkend.
  - Bij Windows Vista selecteert u **Run iStudio.exe** in het AutoPlay-venster.
- 3 Selecteer een map op de computer waarin u nieuwe bestanden wilt opslaan.
  - Als de camera geen nieuwe bestanden bevat, zal het pop-upvenster voor het opslaan van nieuwe bestanden niet verschijnen.
- 4 Selecteer **Ja**.
  - Nieuwe bestanden worden naar de computer overgebracht. U kunt nu het programma Intelli-studio gebruiken.

### Opmerking

#### Intelli-studio

Intelli-studio is een ingebouwd programma waarmee u bestanden kunt afspelen, weergeven of bewerken. U kunt ook bestanden uploaden naar websites zoals Flickr of YouTube.

NL-9



Nederlands

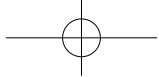

## Websites voor het delen van foto's of video's gebruiken

### Een website openen

- 1 Selecteer in de opname- of weergavemodus → .
  - Er worden beschikbare access points gezocht en op het camerascherm weergegeven.
- 2 Selecteer een access point.
  - De camera maakt verbinding met het WLAN.
  - Als er een wachtwoord voor het geselecteerde access point nodig is, voert u het wachtwoord in.
  - Als de camera niet automatisch met het WLAN verbinding maakt, brengt u de verbinding handmatig tot stand. Voor meer informatie over verbinding maken met een WLAN kunt u bij uw netwerkbeheerder of networkserviceprovider terecht.
- 3 Selecteer een website.
- 4 Voer uw gebruikersnaam en wachtwoord in en selecteer **Aanmelding**.

### Foto's of video's uploaden

- 1 Selecteer .
- 2 Selecteer of om door bestanden te scrollen.
- 3 Sleep foto's en video's naar het selectiegebied of selecteer foto's en video's en selecteer **OK**.

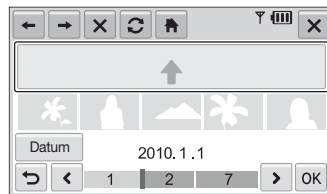

- Selecteer **Datum** om de bestanden te categoriseren.
- 4 Voer een titel in, selecteer een album en selecteer vervolgens .

### Opmerking

- De snelheid waarmee u foto's kunt uploaden en webpagina's kunt openen is afhankelijk van de snelheid van uw internetverbinding.
- Het kan voorkomen dat u geen e-mail kunt verzenden door een probleem met de netwerkverbinding of door de instellingen van de e-mailaccount.

NL-10



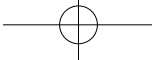

## Specificaties

Beeldsensor	<ul style="list-style-type: none"><li>Type: 1/2,3 inch (circa 7,76 mm) CCD</li><li>Effectieve pixels: circa 14,2 megapixel</li><li>Totaal aantal pixels: circa 14,5 megapixel</li></ul>
Lens	<ul style="list-style-type: none"><li>Brandpuntsafstand: Schneider-KREUZNACH-lens f = 5,6 - 39,2 mm (35-mm equivalent: 31 - 217 mm)</li><li>Diafragmabereik: f/3,3 (G) - f/5,5 (T)</li></ul>
Scherf	3,7-inch (9,4 cm) volledig breedbeeldaanraakscherm
Scherpstelling	TTL-autofocus (Multi AF, Centrum AF, Gezichtsherkenning-AF, Gezichtsdetectie-AF, Smart Touch AF, One Touch-opname)
Sluittijd	<ul style="list-style-type: none"><li>Auto: 1/8 - 1/2000 seconde</li><li>Programma: 1 - 1/2000 seconde</li><li>Nacht: 8 - 1/2000 seconde</li><li>Vuurwerk: 2 seconden</li></ul>
Opslag	<ul style="list-style-type: none"><li>Intern geheugen: circa 13 MB</li><li>Extern geheugen (optioneel): microSD™-kaart (tot 4 GB gegarandeerd)</li></ul> De interne geheugencapaciteit kan van deze specificaties afwijken.
Gelijkstroomaansluiting	20-pins, 4,4 V
Oplaadbare batterij	Lithium-ionbatterij (SLB-11A, 1130 mAh)
Afmetingen (B x H x D)	103,8 x 58,3 x 19,6 mm
Gewicht	161,1 g (zonder batterij en geheugenkaart)
Bedrijfstemperatuur	0 - 40 °C
Bedrijfsvochtigheid	5 - 85%

Nederlands

NL-11

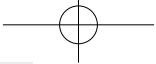

## Sumário

Informações de saúde e segurança .....	2	1
Layout da câmara .....	4	15
Configurando sua câmara ...	5	14
Desembalando .....	5	
Inserindo a bateria e o cartão de memória.....	6	
Carregando a bateria.....	6	
Ligar a câmara .....	7	
Usar o ecrã sensível ao toque ...	7	
Capturando fotos ou vídeos	8	27
Reproduzindo ficheiros .....	9	66
Transferindo ficheiros para um PC (Windows).....	9	86
Usando sites de compartilhamento de fotos ou vídeos .....	10	101
Especificações .....	11	126



## Informações de saúde e segurança



### Avisos

#### **Não use sua câmara próximo a gases e líquidos inflamáveis ou explosivos**

Não use a câmara próximo a combustíveis ou produtos químicos inflamáveis. Não armazene nem transporte líquidos inflamáveis, gases ou materiais explosivos no mesmo compartimento que a câmara ou seus acessórios.

#### **Mantenha a câmara longe do alcance de crianças pequenas e animais domésticos**

Mantenha sua câmara e todos os seus acessórios longe do alcance de crianças pequenas e animais. As peças pequenas poderão causar asfixia ou ferimentos graves se forem ingeridas. As partes móveis e os acessórios também podem representar perigos físicos.

#### **Evite danos à visão de pessoas e animais**

Não use o flash muito próximo (a menos de 1 m) de pessoas ou animais. A utilização do flash muito próximo aos olhos de pessoas ou animais poderá causar danos temporários ou permanentes.

PT-2

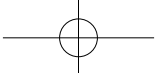

### Manipule e descarte baterias e carregadores com cuidado

- Use somente baterias e carregadores aprovados pela Samsung. Baterias e carregadores incompatíveis podem causar ferimentos graves ou danos à sua câmera.
- Jamais coloque baterias ou câmera em dispositivos de aquecimento, como fornos de microondas, fornos ou radiadores. As baterias poderão explodir se forem superaquecidas.



### Cuidados

#### Manipule e armazene sua câmera com cuidado

- Não molhe a câmera. Líquidos poderão causar sérios danos. Não manipule sua câmera com as mãos molhadas. Danos causados à câmera por água podem invalidar a garantia do fabricante.
- Evite usar ou armazenar sua câmera em locais empoeirados, sujos, úmidos ou com pouca ventilação para evitar avarias às partes móveis e aos componentes internos.

- Tenha cuidado ao conectar cabos ou adaptadores e ao instalar baterias e cartões de memória. Forçar os conectores, conectar cabos incorrectamente ou instalar baterias e cartões de memória de forma inadequada poderá causar danos a portas, conectores e acessórios.
- Não insira objectos estranhos em nenhum dos compartimentos, slots ou pontos de acesso da câmera. Esse tipo de dano pode não ser coberto pela sua garantia.

#### Proteja as baterias, os carregadores e os cartões de memória contra danos

- Evite expor as baterias ou os cartões de memória a temperaturas muito frias ou quentes (abaixo de 0 °C/32 °F ou acima de 40 °C/104 °F). Temperaturas extremas podem reduzir a capacidade de carga das baterias e provocar o funcionamento incorrecto dos cartões de memória.
- Não permita que líquidos, sujidade ou substâncias estranhas entrem em contato com os cartões de memória ou o slot de cartão de memória. Isso poderia causar o mal funcionamento dos cartões de memória e da câmera.
- Não use cartões de memória formatados por outras câmera ou por um computador. Reformate o cartão de memória com a sua câmera.

#### Siga todos os avisos e normas de segurança

Respeite toda e qualquer norma que restrinja o uso de câmeras em áreas específicas.

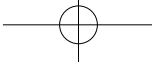

## Layout da câmara

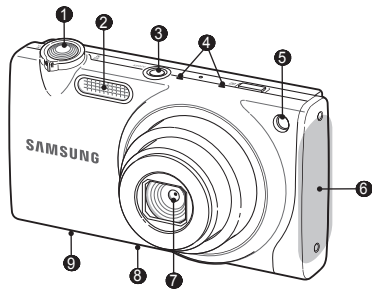

- |   |                                   |
|---|-----------------------------------|
| 1 | Botão do obturador                |
| 2 | Flash                             |
| 3 | Botão de liga/desliga             |
| 4 | Microfone                         |
| 5 | Luz de auxílio do AF/temporizador |
| 6 | Antena interna                    |
| 7 | Lente                             |
| 8 | Colunas                           |
| 9 | Tampa do compartimento da bateria |

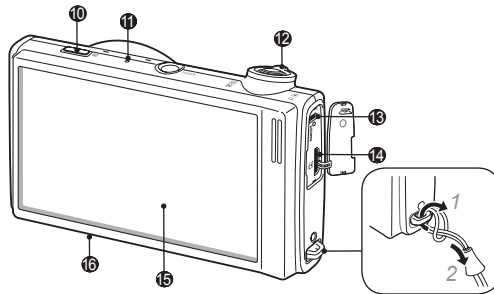

- |    |   |
|----|---|
| 10 | Botão de reprodução                     |
| 11 | Indicador luminoso de status            |
| 12 | Botão de zoom                           |
| 13 | Porta HDMI (Aceita cabo HDMI)           |
| 14 | Porta USB e AV (Aceita cabos USB ou AV) |
| 15 | Ecrã sensível ao toque                  |
| 16 | Encaixe para tripé                      |

PT-4



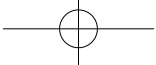

# Configurando sua câmera

## Desembalando



Câmera



Adaptador CA/  
Cabo USB



Bateria recarregável



Alça



Manual de Início  
Rápido

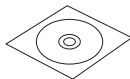

CD-ROM do Manual do  
Usuário

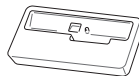

Base

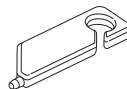

Caneta de toque

## Acessórios opcionais



Bolsa



Cartão de memória  
(microSD™)

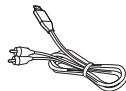

Cabo AV

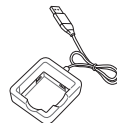

Carregador de  
bateria

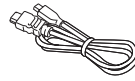

Cabo HDMI

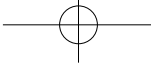

## Configurando sua câmera

### Inserindo a bateria e o cartão de memória

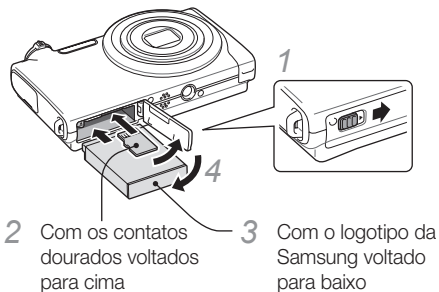

#### ▼ Removendo a bateria

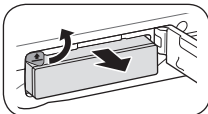

#### ▼ Removendo o cartão de memória

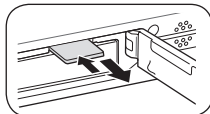

Pressione gentilmente o cartão até que ele seja liberado. Em seguida, puxe-o para fora do slot.

PT-6

### Carregando a bateria

Certifique-se de carregar a bateria antes de usar a câmera.

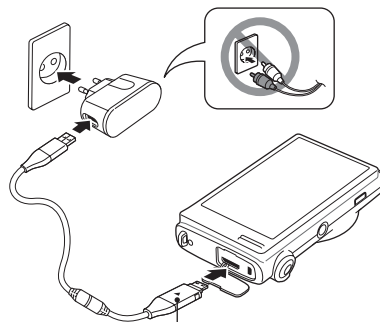

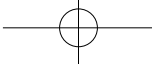

## Ligar a câmara

- 1 Pressione o botão **[POWER]** para ligar ou desligar sua câmara.
  - O ecrã de configuração inicial será exibida quando a câmara for ligada pela primeira vez.

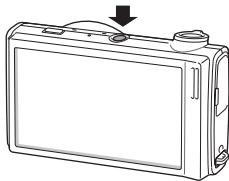

- 2 Selecione um idioma, defina a data e a hora, selecione um fuso horário e calibre a tela.

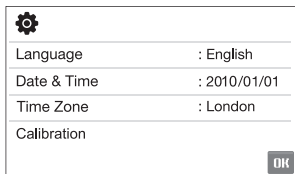

## Usar o ecrã sensível ao toque

Use a caneta de toque fornecida para tocar ou arrastar na tela.



### Cuidado

Não use outros objectos pontiagudos, como canetas ou lápis, para tocar o ecrã. Fazer isso poderá danificá-la.

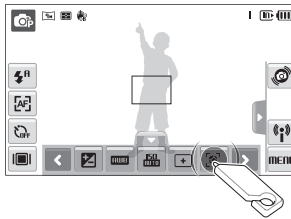

### Tocando

Toque em um ícone para abrir um menu ou ajustar uma opção.

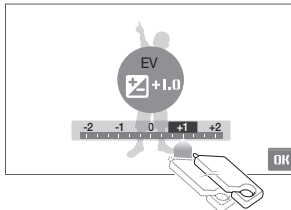

### Arrastando

Arraste para a esquerda ou para a direita para rolar horizontalmente.

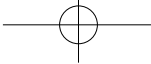

# Capturando fotos ou vídeos

## Tirando uma foto

- 1 Certifique-se de que a câmera esteja no modo (modo Auto).
- 2 Alinhe o objecto no quadro.
- 3 Pressione o botão **[Obturador]** até a metade do curso para focalizar a imagem automaticamente.
  - Um quadro verde significa que o objecto foi focalizado.

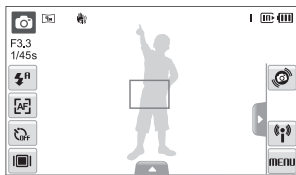

- 4 Pressione o botão **[Obturador]** até o final para tirar a foto.

## Gravando um vídeo

- 1 Selecione → .
- 2 Alinhe o objecto no quadro.
- 3 Pressione o botão **[Obturador]**.
  - Para pausar, selecione **II**.
  - Para continuar, selecione **●**.
- 4 Pressione o botão **[Obturador]** novamente para parar a gravação.

### \* Observação

Número de fotos por resolução (para microSD™ de 1 GB)

	Resolução	Super fino	Fino	Normal
<b>Hi</b>	4320 X 3240	122	240	353
<b>P</b>	4000 X 3000	142	278	409
<b>1080</b>	3984 X 2656	160	312	454
<b>720</b>	3840 X 2160	206	401	588
<b>B</b>	3264 X 2448	211	409	594
<b>S</b>	2560 X 1920	335	637	908
<b>3</b>	2048 X 1536	510	936	1314
<b>2</b>	1920 X 1080	762	1373	1931
<b>L</b>	1024 X 768	1626	2575	3090

Estes valores foram medidos nas condições padrão da Samsung e podem variar em função das condições em que as fotos são tiradas e das configurações da câmera.

PT-8



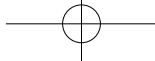

## Reproduzindo ficheiros

### Exibindo fotos

- 1 Pressione o botão **[Reproduzir]**.
- 2 Desenhe uma barra horizontal para a esquerda ou para a direita ou selecione **◀** ou **▶** para percorrer as fotos.
  - Você também pode exibir ficheiros ao inclinar sua câmera.

### Exibindo vídeos

- 1 Pressione o botão **[Reproduzir]** e selecione **▶**.
- 2 Use os ícones a seguir para controlar a reprodução.

	Retroceder
	Pausar ou continuar a reprodução
	Parar a reprodução
	Avançar
	Ajustar o volume ou desativar o som

## Transferindo ficheiros para um PC (Windows)

- 1 Conecte a câmera ao seu computador com um cabo USB.

### Observação

Certifique-se de que a opção **PC Software** esteja definida como **Ligado** no menu de configurações.

- 2 Conecte a câmera.
  - O computador reconhece a câmera automaticamente.
  - No Windows Vista, selecione **Run iStudio.exe** na janela de execução automática.
- 3 Selecione uma pasta no seu computador para salvar os ficheiros novos.
  - Se a sua câmera não possuir ficheiros novos, uma janela pop-up para salvá-los não será exibida.
- 4 Selecione **Sim**.
  - Os ficheiros novos serão transferidos para o seu computador. Você poderá agora usar o programa Intelli-studio.

### Observação

#### Sobre o Intelli-studio

O Intelli-studio é um programa interno que permite reproduzir e editar ficheiros. Você também pode carregar ficheiros em sites, como o Flickr ou o YouTube.

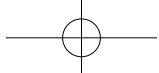

## Usando sites de compartilhamento de fotos ou vídeos

### Acessando um site

- 1 No modo Fotografia ou Reprodução, selecione → .
  - A câmera procurará e exibirá todos os dispositivos AP disponíveis.
- 2 Selecione um dispositivo AP.
  - A câmera conectará à WLAN.
  - Se o dispositivo AP selecionado solicitar uma senha, insira-a.
  - Se a câmera não conectar à WLAN automaticamente, conecte-a manualmente. Para obter mais informações sobre conexão à WLAN, entre em contato com o seu administrador de rede ou com o provedor de serviços de rede.
- 3 Selecione um site.
- 4 Insira sua ID de login e a senha e selecione **Entrar**.

### Carregando fotos ou vídeos

- 1 Selecione .
- 2 Selecione ou para percorrer os arquivos.
- 3 Arraste fotos ou vídeos para a área de seleção ou selecione fotos ou vídeos e clique em **OK**.

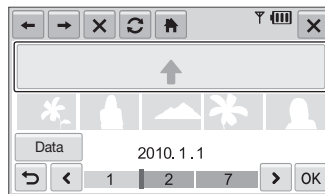

- Selecione **Data** para categorizar os arquivos.
- 4 Insira um título e selecione um álbum. Em seguida, selecione .

### Observação

- A velocidade da sua conexão com a Internet pode afetar a rapidez com que fotos são carregadas ou páginas da Web são abertas.
- Talvez você não possa enviar um email devido às conexões de rede ou configurações de conta de email.

PT-10

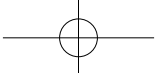

## Especificações

Sensor de imagens	<ul style="list-style-type: none"><li>• Tipo: CCD de 1/2,3" (aprox. 7,76 mm)</li><li>• Pixels efetivos: aprox. 14,2 megapixels</li><li>• Total de pixels: aprox. 14,5 megapixels</li></ul>
Lente	<ul style="list-style-type: none"><li>• Comprimento focal: Lente Schneider-KREUZNACH f = 5,6 - 39,2 mm (equivalente de filme de 35 mm: 31 - 217 mm)</li><li>• Faixa de F-stop: F3,3 (W) - F5,5 (T)</li></ul>
Ecrã	Painel sensível ao toque completo de 3,7" (9,4 cm) Wide
Foco	Foco automático TTL (Multi af, Af central, AF de reconhecimento de faces, AF de deteção de faces, Smart Touch AF, Fotografia com um toque)
Velocidade do obturador	<ul style="list-style-type: none"><li>• Auto: 1/8 - 1/2000 s.</li><li>• Programa: 1 - 1/2000 s</li><li>• Noite: 8 - 1/2000 s</li><li>• Fogo Artificio: 2 s</li></ul>
Armazenamento	<ul style="list-style-type: none"><li>• Memória interna: aprox. 13 MB</li><li>• Memória externa (Opcional): cartão microSD™ (até 4 GB garantidos)</li></ul> A capacidade da memória interna pode não atender a estas especificações.
Conector de entrada de alimentação CC	20 pinos, 4,4 V
Bateria recarregável	Bateria de ions de lítio (SLB-11A, 1130 mAh)
Dimensões (L x A x P)	103,8 x 58,3 x 19,6 mm
Peso	161,1 g (sem a bateria e o cartão de memória)
Temperatura de operação	0 - 40 °C
Umidade de operação	5 - 85%

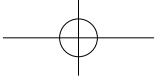

Please refer to the warranty that came with your product  
or visit our website <http://www.samsungimaging.com/>  
for after-sales service or inquiries.



CE0678

AD68-04774A (1.0)