



About the manuals

To see the detailed information about WALKMAN®, access to Help Guide on the internet.

http://rd1.sony.net/help/dmp/nwzm500/h_ww/



While browsing is free, you may be charged a communication fee according to your carrier contract.

Regarding the basic operations, the customer support website URL and Important Information, refer to "How to Install and Read the Help Guide" section on this manual.



* 4 5 3 9 9 3 9 1 2 * (1)

Contents

Please check the items in the package.

- Walkman (1)
- Headphones (1)
- Earbuds (1 set)
- Quick Start Guide (this manual)
- USB cable (1)
- Clip (1)

Charging the Battery

Charge your Walkman by connecting it to a computer.

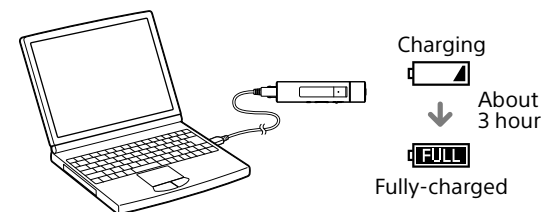

When your Walkman has been fully charged, disconnect it from the computer.

Hint

- You can check the remaining battery charge on the music playback and the FM radio screens.

Note

- To prevent battery deterioration, charge the battery at least once every six months or every year.
- You cannot operate your Walkman while charging the battery.

How to Install and Read the Help Guide

Install the "Help Guide" on your computer. This contains basic operations of your Walkman, the customer support website URL, and how to transfer content such as music to the Walkman.

1 Connect your Walkman to a running computer.

2 Open the following folders and double-click the executable file on your Walkman.

- Windows 7 or earlier: [Start] – [Computer] – [WALKMAN] – [FOR_WINDOWS] – [Help_Guide_Installer(.exe)].
- Windows 8: [Start screen] – [Desktop] – [File Explorer] – [Computer] – [WALKMAN] – [FOR_WINDOWS] – [Help_Guide_Installer(.exe)].
- Windows 8.1: [Desktop] – [File Explorer] – [This PC] – [WALKMAN] – [FOR_WINDOWS] – [Help_Guide_Installer(.exe)].
- Mac: [Finder] – [WALKMAN] – [FOR_MAC] – [Help_Guide_Installer_for_mac].

3 Follow the on-screen instructions to complete the installation.

4 To read the Help Guide, double-click the shortcut or the alias icon generated on your computer.

Parts and Controls

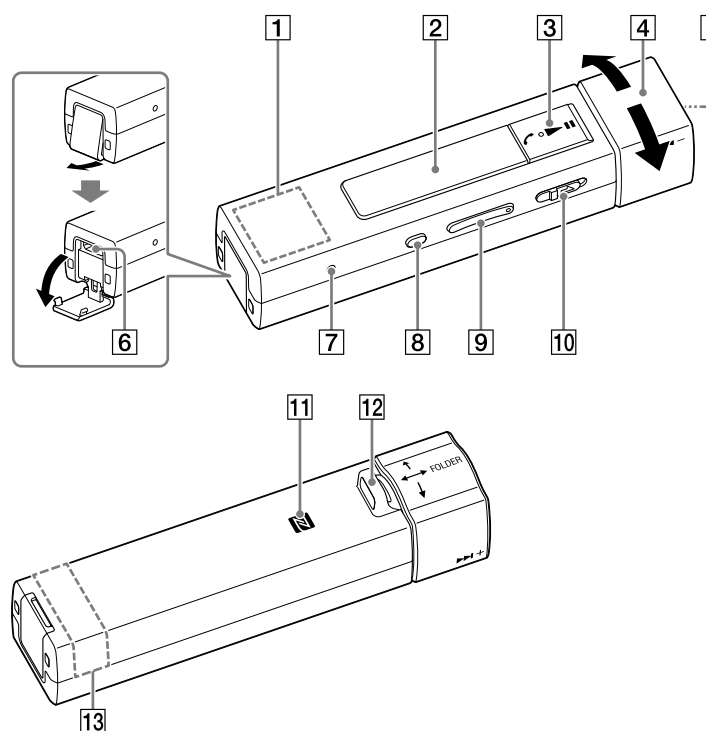

1 Built-in microphone

2 Display

3 [Play/Pause] button (*1)

- Turn the power on/off
- Execute the desired items
- Play/pause music
- Answer incoming calls

4 Shuttle switch

Rotate to select an item or to perform the following operations.

- Fast forward/fast rewind music
- Go to the beginning of the previous (or current) song or go to the beginning of the next song
- Select the previous or next preset FM broadcast station

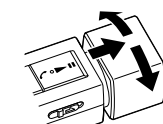

Pull out and rotate to perform the following operations.

- Skip to the previous/next folder
- Select a FM broadcast station manually

5 Headphone jack

Insert the headphone plug until it clicks into place.

6 USB jack

7 RESET button

Press the RESET button with pen or a paper clip, etc. to reset your Walkman.

8 HOME•BACK button

- Go back to the previous screen
- End/cancel a call
- Press and hold to display [Music] in the Home menu.

9 VOL (Volume) + (*1)/- button

Press to adjust the volume. Press the VOL + button to turn up and the VOL – button to turn down the volume.

10 HOLD switch

Disables the operation buttons to avoid accidental operation while carrying your Walkman.

11 N-mark

Touch a smartphone equipped with an NFC function to this mark to connect it to your Walkman.

12 Strap hole

13 Built-in Bluetooth antenna

Do not cover the antenna part with your hands or other object when a Bluetooth connection is active. Doing so may interrupt the connection.

About volume operation (Only for countries/areas complying with European and Korean Directives)

An alarm (beep) and a warning [Check the volume level] are meant to protect your ears when you turn the volume up to a level that is harmful for your ears for the first time. You can cancel the alarm and warning by pressing any button.

Note

- You can turn up the volume after canceling the alarm and warning.
- After the initial warning, the alarm and warning repeat every 20 cumulative hours that the volume is set to a level that is harmful for your ears. When this happens, the volume is turned down automatically.
- If the volume is set to a level that is harmful for your ears and you turn off the Walkman, the volume is turned down to a level that is safe for your ears automatically.

Attaching the clip

Use the clip (supplied) to attach your Walkman to the pocket of your clothes or to your bag.

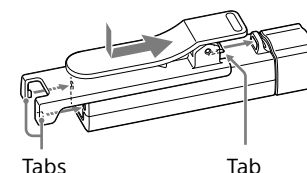

Place the clip as illustrated and slide it in the direction of the arrow until the three tabs are firmly fixed.

Hint

- To remove the clip, slide it in the opposite direction of the arrow.

Note

- If a strap is attached to your Walkman, remove it before attaching the clip.
- Remove the clip when you make a one-touch connection (NFC) with a smartphone.

Turning the power on and off

Turning the power on

Slide the HOLD switch in the direction opposite to that of the arrow. Press the [Play/Pause] button.

Selecting the display language

You can select the language for menus and messages.

1 From the Home menu, select [Settings].

2 Select [Language Settings] - Desired language setting.

Turning the power off

Press and hold the [Play/Pause] button.

Hint

- If there is no operation, the screen will be turned off. To turn on the screen, press the HOME•BACK button.
- If there is no operation for an extended period, your Walkman will be turned off automatically.
- Select the display language before transferring content.

*1 There are tactile dots. Use them to help with button operations.

How to Use your Walkman

The Home menu is the starting point of each application.

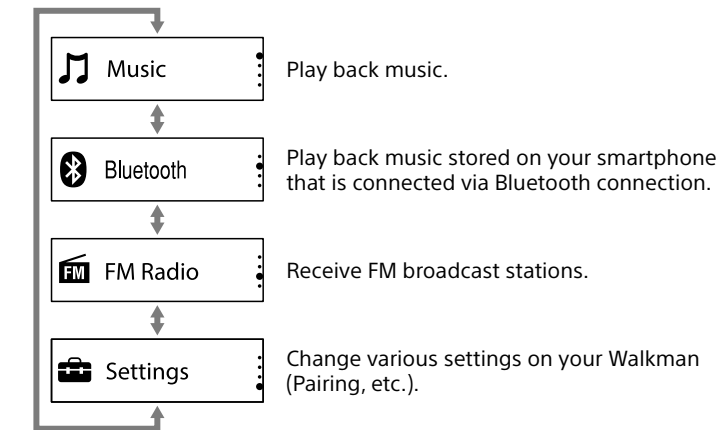

To display [Music] on the Home menu	Press and hold the HOME•BACK button.
To select an item	Rotate the shuttle switch to select the desired menu, and then press the  button to confirm.
To return to the previous screen	Press the HOME•BACK button.



The screens and illustrations shown are for reference only and may differ from the actual product or screen.

Playing Music

Enjoy playing music transferred to your Walkman.

1 From the Home menu, select  [Music], and then press the  button.

2 Select the desired search method and items until a song list appears, and then select the desired song.

Playback starts and the music playback screen is displayed. Press the  button again to pause playback on the music playback screen.

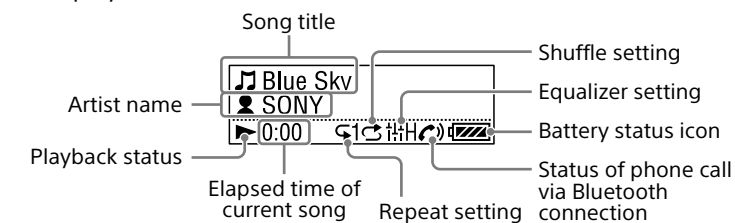

Hint

- If there is no operation during music playback, the screen will be turned off.
- To return to the music playback screen from other screens during music playback, press and hold the HOME•BACK button to display  [Music], and then press the HOME•BACK button again.
- If there is no operation for an extended period while paused, your Walkman will be turned off automatically.
- For detailed instructions on transferring music to your Walkman, various music playback operations, listening to FM radio, and various settings, refer to the Help Guide installed on your computer or at the URL mentioned in the "About the manuals" section on the cover page of this manual.

Pairing and Connecting to Your Smartphone

You can use your Walkman as a wireless headset for listening to music stored on your smartphone. However, you cannot listen to music or FM radio being played on the Walkman wirelessly through Bluetooth speakers or headphones.

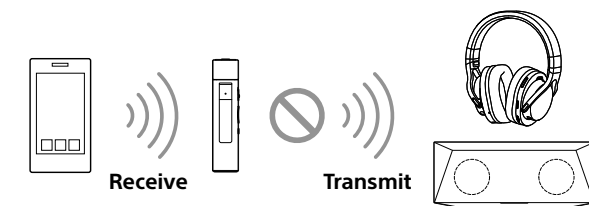

1 Put your Walkman in pairing mode.

From the Home menu of your Walkman, select  [Settings] – [Bluetooth Settings] – [Bluetooth On/Off] – [Bluetooth On] – [Add Device (Pairing)].

2 On your smartphone, turn on the Bluetooth function, and then search your Walkman on the Bluetooth settings screen.

When the list of detected devices appears on the Bluetooth settings screen, tap [NWZ-M504]. If passkey input is required, input "0000." Follow the on-screen instructions to complete the pairing.

Your Walkman and the smartphone are paired to each other and a connection is made.

Hint

- To turn off the Bluetooth function, from the Home menu of your Walkman, select  [Settings] – [Bluetooth Settings] – [Bluetooth On/Off] – [Bluetooth Off].
- You can pair your Walkman and smartphone using the one-touch (NFC) function.

- For detailed instructions, refer to the Help Guide installed on your computer or at the URL mentioned in the "About the manuals" section on the cover page of this manual.

Answering/Hanging up a Call

You can answer and hang up a phone call to your smartphone.

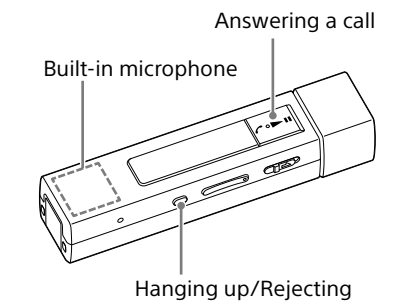

Answering a call

Press the  button while receiving a call. To reject an incoming call, press the HOME•BACK button while receiving a call.

Hint

- The microphone is built-in inside where the Sony logo is.
- Volume for calls and for music can be adjusted independently.
- When your Walkman is turned off automatically, the Bluetooth connection is disconnected and you cannot receive phone calls.

Hanging up a call

Press the HOME•BACK button.

Troubleshooting

If your Walkman does not function as expected, try the following steps to resolve the issue.

1 Find the symptoms of the issue in "Troubleshooting" in the Help Guide (HTML document), and try any corrective actions listed.

2 Connect your Walkman to your computer to charge the battery.

3 Press the RESET button with a pen or paper clip, etc.

4 After resetting your Walkman, press the  button to turn on the Walkman.

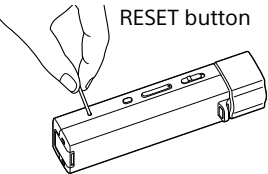

Symptom & Remedy

Your Walkman cannot charge the battery or is not recognized on your computer.

- The USB cable (supplied) is not connected to a USB connector on your computer properly. Disconnect the USB cable, and then reconnect it.
- Use the supplied USB cable.
- When you use your Walkman for the first time, or if you have not used the Walkman for a long time, it may take a few minutes to be recognized by the computer. Check that the computer recognizes the Walkman after you have connected it to the computer for about 10 minutes.

Your Walkman does not operate or the power does not turn on.

- You cannot operate your Walkman while charging the battery. Wait until charging is complete.

You cannot pair to a smartphone.

- Your walkman works as a Bluetooth receiver and cannot connect to Bluetooth speakers or headphones as they also work as receivers.
- If the support profiles are different, your Walkman and smartphone cannot be paired. For more information, refer to the "Specification" section on the Help Guide.

Precautions

Information on laws and trademarks

For information on laws, regulations and trademark rights, refer to "Important Information" contained in the supplied software. To read it, install the supplied software on your computer.

About the headphones

- Avoid playing the unit at so loud a volume that extended play might affect your hearing.
- At a high volume outside sounds may become inaudible. Avoid listening to the unit in situations where hearing must not be impaired, for example, while driving or cycling.
- As the headphones are of open-air design, sounds go out through the headphones. Remember not to disturb those close to you.

About the in-ear headphones

The earbuds seal your ears. Therefore, be aware that there is a risk of damage to your ears or eardrums if strong pressure is applied to the earbuds or the earbuds are suddenly removed from your ears. After use, be sure to take the earbuds off your ears gently.

Design and specifications are subject to change without notice.