

Additional information on this product and answers to frequently asked questions can be found at our Customer Support Website.

<http://www.sony.net/>

Printed using VOC (Volatile Organic Compound)-free vegetable oil based ink.

©2012 Sony Corporation Printed in Thailand



4437511110

English

Owner's Record

The model and serial numbers are located on the bottom. Record the serial number in the space provided below. Refer to these numbers whenever you call your Sony dealer regarding this product.

Model No. NEX-5R

Serial No. _____

Model No. AC-UB10/AC-UB10B/AC-UB10C/AC-UB10D

Serial No. _____

WARNING

To reduce fire or shock hazard, do not expose the unit to rain or moisture.

IMPORTANT SAFETY INSTRUCTIONS

-SAVE THESE INSTRUCTIONS

DANGER

**-TO REDUCE THE RISK OF FIRE OR
ELECTRIC SHOCK, CAREFULLY FOLLOW
THESE INSTRUCTIONS**

If the shape of the plug does not fit the power outlet, use an attachment plug adaptor of the proper configuration for the power outlet.

CAUTION

Battery pack

If the battery pack is mishandled, the battery pack can burst, cause a fire or even chemical burns. Observe the following cautions.

- Do not disassemble.
- Do not crush and do not expose the battery pack to any shock or force such as hammering, dropping or stepping on it.
- Do not short circuit and do not allow metal objects to come into contact with the battery terminals.
- Do not expose to high temperature above 60°C (140°F) such as in direct sunlight or in a car parked in the sun.

- Do not incinerate or dispose of in fire.
- Do not handle damaged or leaking lithium ion batteries.
- Be sure to charge the battery pack using a genuine Sony battery charger or a device that can charge the battery pack.
- Keep the battery pack out of the reach of small children.
- Keep the battery pack dry.
- Replace only with the same or equivalent type recommended by Sony.
- Dispose of used battery packs promptly as described in the instructions.

AC Adaptor

Use the nearby wall outlet (wall socket) when using the AC Adaptor. Disconnect the AC Adaptor from the wall outlet (wall socket) immediately if any malfunction occurs while using the apparatus.

The power cord (mains lead), if supplied, is designed specifically for use with this camera only, and should not be used with other electrical equipment.

For Customers in the U.S.A. and Canada

RECYCLING LITHIUM-ION BATTERIES

Lithium-Ion batteries are recyclable.

You can help preserve our environment by returning your used rechargeable batteries to the collection and recycling location nearest you.



For more information regarding recycling of rechargeable batteries, call toll free 1-800-822-8837, or visit <http://www.rbrrc.org/>

Caution: Do not handle damaged or leaking Lithium-Ion batteries.

Battery pack and lens (If lens supplied)

This device complies with Part 15 of the FCC Rules. Operation is subject to the following two conditions:

(1) This device may not cause harmful interference, and (2) this device must accept any interference received, including interference that may cause undesired operation.

This Class B digital apparatus complies with Canadian ICES-003.

This equipment complies with FCC/IC radiation exposure limits set forth for an uncontrolled environment and meets the FCC radio frequency (RF) Exposure Guidelines in Supplement C to OET65 and RSS-102 of the IC radio frequency (RF) Exposure rules. This equipment has very low levels of RF energy that are deemed to comply without testing of specific absorption ratio (SAR).

For Customers in the U.S.A.

UL is an internationally recognized safety organization.
The UL Mark on the product means it has been UL Listed.

If you have any questions about this product, you may call:
Sony Customer Information Center
1-800-222-SONY (7669)

The number below is for the FCC related matters only.

Regulatory Information

Declaration of Conformity

Trade Name: SONY

Model No.: NEX-5R

Responsible Party: Sony Electronics Inc.

Address: 16530 Via Esprillo, San Diego, CA 92127 U.S.A.

Telephone No.: 858-942-2230

This device complies with Part 15 of the FCC Rules. Operation is subject to the following two conditions: (1) This device may not cause harmful interference, and (2) this device must accept any interference received, including interference that may cause undesired operation.

This equipment must not be co-located or operated in conjunction with any other antenna or transmitter.

CAUTION

You are cautioned that any changes or modifications not expressly approved in this manual could void your authority to operate this equipment.

Note:

This equipment has been tested and found to comply with the limits for a Class B digital device, pursuant to Part 15 of the FCC Rules.

These limits are designed to provide reasonable protection against harmful interference in a residential installation. This equipment generates, uses, and can radiate radio frequency energy and, if not installed and used in accordance with the instructions, may cause harmful interference to radio communications. However, there is no guarantee that interference will not occur in a particular installation. If this equipment does cause harmful interference to radio or television reception, which can be determined by turning the equipment off and on, the user is encouraged to try to correct the interference by one or more of the following measures:

- Reorient or relocate the receiving antenna.
- Increase the separation between the equipment and receiver.
- Connect the equipment into an outlet on a circuit different from that to which the receiver is connected.
- Consult the dealer or an experienced radio/TV technician for help.

The supplied interface cable must be used with the equipment in order to comply with the limits for a digital device pursuant to Subpart B of Part 15 of FCC Rules.

For Customers in Canada

This device complies with Industry Canada licence-exempt RSS standard(s). Operation is subject to the following two conditions: (1) this device may not cause interference, and (2) this device must accept any interference, including interference that may cause undesired operation of the device.

Under Industry Canada regulations, this radio transmitter may only operate using an antenna of a type and maximum (or lesser) gain approved for the transmitter by Industry Canada. To reduce potential radio interference to other users, the antenna type and its gain should be so chosen that the equivalent isotropically radiated power (e.i.r.p.) is not more than that necessary for successful communication.

For Customers in Europe

Notice for the customers in the countries applying EU Directives

The manufacturer of this product is Sony Corporation, 1-7-1 Konan Minato-ku Tokyo, 108-0075 Japan. The Authorized Representative for EMC and product safety is Sony Deutschland GmbH, Hedelfinger Strasse 61, 70327 Stuttgart, Germany. For any service or guarantee matters please refer to the addresses given in separate service or guarantee documents.



Hereby, Sony Corporation, declares that this NEX-5R Interchangeable Lens Digital Camera is in compliance with the essential requirements and other relevant provisions of the Directive 1999/5/EC. For details, please access the following URL:
<http://www.compliance.sony.de/>

This product has been tested and found compliant with the limits set out in the R&TTE Directive for using connection cables shorter than 3 meters (9.8 feet).

Attention

The electromagnetic fields at the specific frequencies may influence the picture and sound of this unit.

Notice

If static electricity or electromagnetism causes data transfer to discontinue midway (fail), restart the application or disconnect and connect the communication cable (USB, etc.) again.

Disposal of Old Electrical & Electronic Equipment (Applicable in the European Union and other European countries with separate collection systems)



This symbol on the product or on its packaging indicates that this product shall not be treated as household waste. Instead it shall be handed over to the applicable collection point for the recycling of electrical and electronic equipment. By ensuring this product is disposed of correctly, you will help prevent potential negative consequences for the environment and human health, which could otherwise be caused by inappropriate waste handling of this product. The recycling of materials will help to conserve natural resources. For more detailed information about recycling of this product,

please contact your local Civic Office, your household waste disposal service or the shop where you purchased the product.

Disposal of waste batteries (applicable in the European Union and other European countries with separate collection systems)



This symbol on the battery or on the packaging indicates that the battery provided with this product shall not be treated as household waste. On certain batteries this symbol might be used in combination with a chemical symbol. The chemical symbols for mercury (Hg) or lead (Pb) are added if the battery contains more than 0.0005% mercury or 0.004% lead.

By ensuring these batteries are disposed of correctly, you will help prevent potentially negative consequences for the environment and human health which could otherwise be caused by inappropriate waste handling of the battery. The recycling of the materials will help to conserve natural resources.



In case of products that for safety, performance or data integrity reasons require a permanent connection with an incorporated battery, this battery should be replaced by qualified service staff only. To ensure that the battery will be treated properly, hand over the product at end-of-life to the applicable collection point for the recycling of electrical and electronic equipment.

For all other batteries, please view the section on how to remove the battery from the product safely.

Hand the battery over to the applicable collection point for the recycling of waste batteries. For more detailed information about recycling of this product or battery, please contact your local Civic Office, your household waste disposal service or the shop where you purchased the product.

Notice for customers in the United Kingdom

A moulded plug complying with BS 1363 is fitted to this equipment for your safety and convenience.

Should the fuse in the plug supplied need to be replaced, a fuse of the same rating as the supplied one and approved by ASTA or BSI to BS 1362, (i.e., marked with an  or  mark) must be used.

If the plug supplied with this equipment has a detachable fuse cover, be sure to attach the fuse cover after you change the fuse. Never use the plug without the fuse cover. If you should lose the fuse cover, please contact your nearest Sony service station.

Caution if using the camera in Italy

Use of the RLAN network is governed: - with respect to private use, by the Legislative Decree of 1.8.2003, no. 259 (“Code of Electronic Communications”). In particular Article 104 indicates when the prior obtaining of a general authorization is required and Art. 105 indicates when free use is permitted; - with respect to the supply to the public of the RLAN access to telecom networks and services, by the Ministerial Decree 28.5.2003, as amended, and Art. 25 (general authorization for electronic communications networks and services) of the Code of electronic communications.

Caution if using the camera in Norway

Use of this radio equipment is not allowed in the geographical area with in a radius of 20 km from the centre of Ny-Alesund, Svalbard.

For Customers in Singapore

Complies with IDA Standards DB00353

For customers who purchased their camera from a store in Japan that caters to tourists

Note

All Wireless function designated for the NEX-5R Interchangeable Lens Digital Camera are applicable in the U.S.A., Canada, Mexico, France, Sweden, Russia, Ukraine, Australia, Singapore, Korea, the Philippines, Thailand, Taiwan, India and China.

Table of contents

Preparing the camera

Checking the supplied items	11
Identifying parts	12
Charging the battery pack	17
Attaching/removing the lens	22
Inserting a memory card (sold separately)	24
Attaching the flash	26
Setting the date and time	28

Mastering the basic operation

Shooting still images	30
Recording movies	32
Playing back images	33
Deleting images	35
Operating the camera	36
Using the guide function of the camera	40

Using the recording functions

Setting the function using [Photo Creativity]	41
Adjusting the brightness of still images (Exposure compensation).....	44
Using the self-timer	44
Shooting still images continuously	45
Changing the screen display (DISP).....	46
Shooting with various shooting modes.....	47
Zooming	53
Selecting the flash mode.....	54
Setting using the Fn (Function) button	55
Selecting the image size/record setting.....	56

Using the playback functions

Displaying the image list	57
Viewing images on a TV	58

Checking the functions available

Menu list.....	59
Functions available for each shooting mode.....	69
Flash modes available	70

Importing images to the computer

Installing the software	71
What you can do with the supplied software.....	73

Adding functions to the camera

Adding functions to the camera	75
--------------------------------------	----

Connecting the camera to a network

Transferring images to a Smartphone	77
Connecting to a network.....	78
Saving images to a computer	79
Viewing images on a TV	80

Others

Checking the number of recordable images.....	81
List of icons on the LCD screen.....	84
Learning more about the camera (α Handbook).....	88
Troubleshooting	89
Precautions	94
Specifications	99
Index.....	104

This manual covers several models supplied with different lenses.
The model name varies depending on the supplied lens. The available model varies depending on the countries/regions.

Model name	Lens
NEX-5R	Not supplied
NEX-5RL	E16 – 50 mm
NEX-5RK	E18 – 55 mm
NEX-5RY	E55 – 210 mm and E16 – 50 mm

Checking the supplied items

First check the model name of your camera (page 10). The accessories supplied differ depending on the model.

The number in parentheses indicates the quantity.

■ Comes with all models

- Camera (1)
- Power cord (mains lead) (1)* (not supplied in the U.S.A. and Canada)



* Multiple power cords may be supplied with your camera. Use the appropriate one that matches your country/region.

- Rechargeable battery pack NP-FW50 (1)



- Micro USB cable (1)

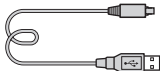

- AC adaptor AC-UB10/UB10B/UB10C/UB10D (1)

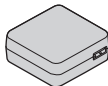

- Shoulder strap (1)

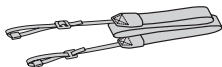

- Flash HVL-F7S (1)/Flash case (1)

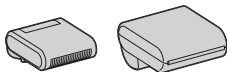

- CD-ROM (1)
 - Application Software for α camera
 - α Handbook
- Instruction Manual (This manual) (1)

■ NEX-5R

- Body cap (1) (attached to the camera)

■ NEX-5RL

- E16 – 50 mm zoom lens (1)/Front lens cap (1) (attached to the camera)

■ NEX-5RK

- E18 – 55 mm zoom lens (1)/Front lens cap (1) (attached to the camera)/Lens hood (1)

■ NEX-5RY

- E16 – 50 mm zoom lens (1)/Front lens cap (1) (attached to the camera)
- E55 – 210 mm zoom lens (1)/Front lens cap (1)/Rear lens cap (1)/Lens hood (1)

Identifying parts

See the pages in parentheses for details on operation for the parts.

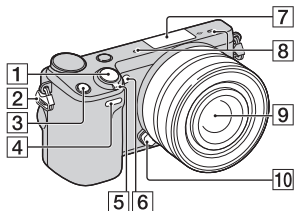

- 6** AF illuminator/Self-timer lamp/
Smile Shutter lamp
- 7** Smart Accessory Terminal 2¹⁾
- 8** Microphone²⁾
- 9** Lens (22)
- 10** Lens release button (23)
- 11** Mount
- 12** Image sensor³⁾
- 13** Lens contacts³⁾

When the lens is removed

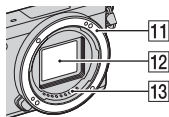

- 1) Accessories for the Smart Accessory Terminal can also be attached.
You cannot use the [Self-portrait Self-timer] function when a flash HVL-F7S (supplied) or accessories are attached to the Smart Accessory Terminal 2.
- 2) Do not cover this part during movie recording.
- 3) Do not touch this part directly.

- 1** Shutter button (31)
- 2** Hook for shoulder strap
Attach the shoulder strap to prevent damage caused by dropping the camera.

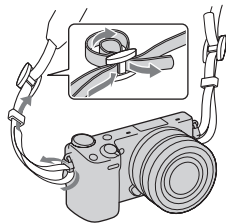

- 3** Fn (Function) button (55)
- 4** Remote sensor
- 5** ON/OFF (Power) switch (28)

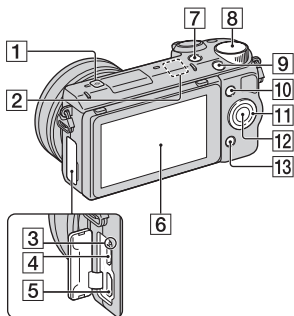

- 1** ⊖ Image sensor position mark
- 2** Wi-Fi sensor (built-in)
- 3** Charge lamp
- 4** Micro USB terminal
- 5** HDMI terminal (58)
- 6** LCD screen/Touch panel⁴⁾ (38)
- 7** ▶ (Playback) button (33)
- 8** Control dial (37)
- 9** MOVIE button (32)
- 10** Soft key A (37)
- 11** Control wheel (36)
- 12** Soft key C (37)
- 13** Soft key B (37)

4)

- You can adjust the LCD screen to an easily viewable angle and shoot from any position.

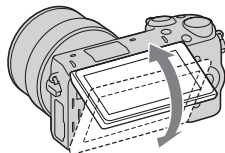

- Tilt the LCD screen upward about 180 degrees when you take a self-portrait. The 3-second delay self-timer is automatically selected in the default setting.

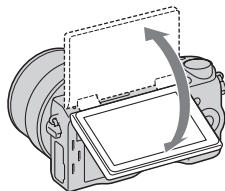

- When storing the LCD screen after Self-portrait shooting, lower the LCD screen completely until it fits against the camera body, then slide the LCD screen upward until both the bottoms of the LCD screen and the camera body are aligned.

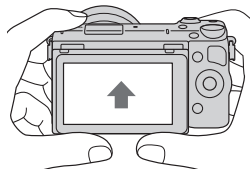

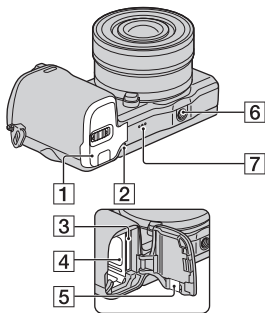

- 1** Battery/memory card cover (17, 24)
- 2** Access lamp (25)
- 3** Memory card insertion slot (24)
- 4** Battery compartment (17)
- 5** Connection plate cover

Use this when using an AC-PW20 AC Adaptor (sold separately). Insert the connection plate into the battery compartment, and then pass the cord through the connection plate cover as shown below.

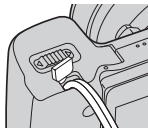

- Make sure that the cord is not pinched when you close the cover.

- 6** Tripod socket hole
 - Use a tripod with a screw length of less than 5.5 mm (7/32 inch). You will be unable to firmly secure the camera to tripods using screws longer than 5.5 mm (7/32 inch), and may damage the camera.
- 7** Speaker

Flash HVL-F7S

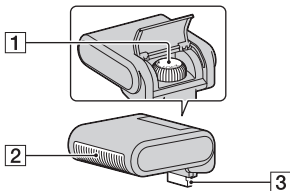

- 1** Screw
- 2** Flash¹⁾
- 3** Connector¹⁾

- ¹⁾ Do not touch this part directly. If it is dirty, wipe it off with a soft clean cloth.

■ Lens

See page 101 on the specifications of the lenses.

E PZ 16 – 50 mm F3.5-5.6 OSS (supplied with NEX-5RL/NEX-5RY)

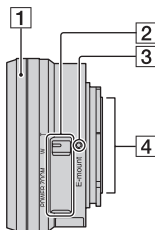

- 1 Zooming/Focusing ring
- 2 Zooming lever
- 3 Mounting index
- 4 Lens contacts¹⁾

¹⁾ Do not touch this part directly.

E18 – 55 mm F3.5-5.6 OSS (supplied with NEX-5RK)

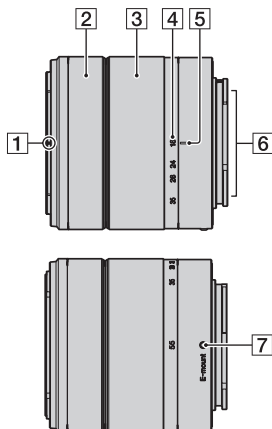

- 1 Hood index
- 2 Focusing ring
- 3 Zooming ring
- 4 Focal-length scale
- 5 Focal-length index
- 6 Lens contacts¹⁾
- 7 Mounting index

¹⁾ Do not touch this part directly.

E55 – 210 mm F4.5-6.3 OSS (supplied with NEX-5RY)

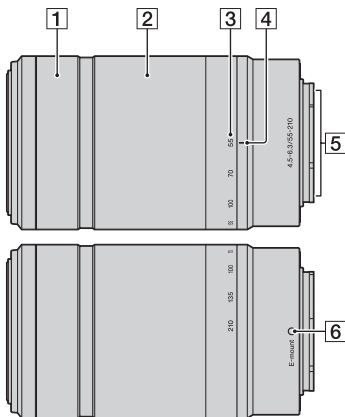

Preparing the camera

- 1 Focusing ring
- 2 Zooming ring
- 3 Focal-length scale
- 4 Focal-length index
- 5 Lens contacts¹⁾
- 6 Mounting index

¹⁾ Do not touch this part directly.

Charging the battery pack

When using the camera for the first time, be sure to charge the NP-FW50 “InfoLITHIUM” battery pack (supplied).

The “InfoLITHIUM” battery pack can be charged even when it has not been fully depleted. The battery pack can also be used when it has not been fully charged.

The charged battery pack is discharged little by little, even when you do not use it. To avoid missing an opportunity to shoot, charge the battery pack again before you shoot.

-
- 1 Set the power switch to OFF.

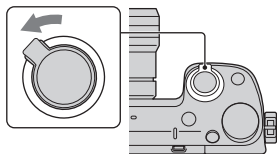

-
- 2 Open the cover by sliding the lever.

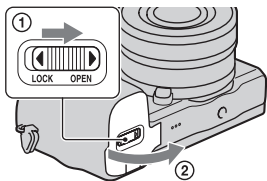

-
- 3 Insert the battery pack completely, using the tip of the battery to press the lock lever.

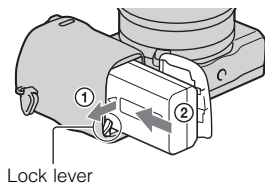

4 Close the cover.

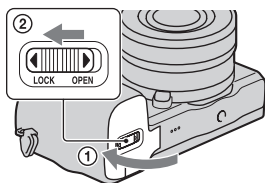

5 Connect the camera to the AC Adaptor (supplied), using the micro USB cable (supplied). Connect the AC Adaptor to the wall outlet (wall socket).

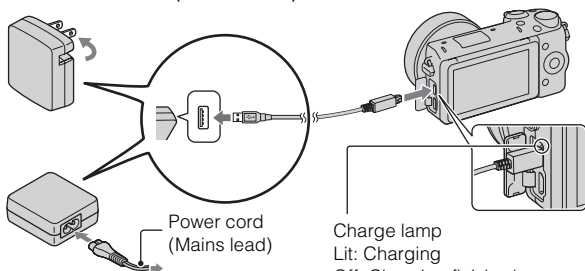

The charge lamp lights orange, and charging starts.

- Set the power switch to OFF while charging the battery. If the power switch is set to ON, the camera cannot charge the battery.
- When the charge lamp flashes, remove and re-insert the battery pack.

Charge lamp

Lit: Charging

Off: Charging finished

Flashing: Charging error or charging temporarily stopped because the temperature is outside the recommended range

Notes

- If the charge lamp on the camera flashes when the AC Adaptor is connected to the wall outlet (wall socket), this indicates that charging is temporarily stopped because the temperature is outside the recommended range. When the temperature gets back within the appropriate range, the charging resumes. We recommend charging the battery pack in an ambient temperature of between 10 °C and 30 °C (50 °F and 86 °F).
- The charge lamp may flash quickly when the battery pack is used for the first time, or the battery pack has not been used for a long time. In such cases, remove the battery pack and re-insert it, and then charge the battery pack.
- Do not try to charge the battery pack again right after it has been charged, or when it has not been used after being charged. Doing so will affect the performance of the battery pack.
- When charging is finished, disconnect the AC Adaptor from the wall outlet (wall socket).
- Be sure to use only genuine Sony brand battery packs, micro USB cable (supplied) and AC Adaptor (supplied).

■ Charging time

The charging time is approximately 280 min. using the AC Adaptor (supplied).

Notes

- The above charging time applies when charging a fully depleted battery pack at a temperature of 25 °C (77 °F). Charging may take longer depending on conditions of use and circumstances.

Charging by connecting to a computer

The battery pack can be charged by connecting the camera to a computer using a micro USB cable.

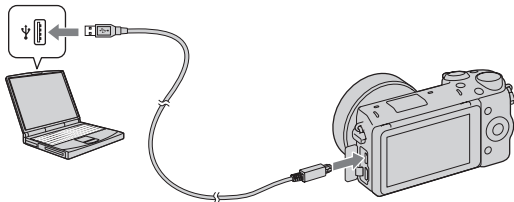

Notes

- Note the following points when charging via a computer:
 - If the camera is connected to a laptop computer that is not connected to a power source, the laptop battery level decreases. Do not leave the camera connected to a computer for an extended period of time.
 - Do not turn on/off or restart the computer, or wake the computer to resume from sleep mode when a USB connection has been established between the computer and the camera. The camera may cause a malfunction. Before turning on/off, or restarting the computer or waking the computer from sleep mode, disconnect the camera from the computer.
 - We do not guarantee operation with all computers. No guarantees are made for charging using a custom-built computer, a modified computer, or charging via a USB hub. You may not be able to operate the camera properly, depending on the types of USB devices you are using at the same time.



Using your camera abroad — Power source

You can use your camera and AC Adaptor in any countries/regions where the power supply is within 100 V to 240 V AC, 50 Hz/60 Hz.

An electronic voltage transformer is unnecessary and its use may cause a malfunction.

■ Checking the remaining battery level

Check the level with the following indicators and percent figures displayed on the LCD screen.

						"Battery exhausted."
Battery level	High Low					You cannot shoot any more image.

Notes

- The displayed battery power level may not be correct under certain circumstances.



What is an "InfoLITHIUM" battery pack?

An "InfoLITHIUM" battery pack is a lithium-ion battery pack that has functions for exchanging information related to operating conditions with your camera. Using the "InfoLITHIUM" battery pack, the remaining battery time in percent figures is displayed according to the operating conditions of your camera.

■ Removing the battery pack

Turn off the camera, make sure that the access lamp is not lit, slide the lock lever in the direction of the arrow, and pull out the battery pack. Be careful not to drop the battery pack.

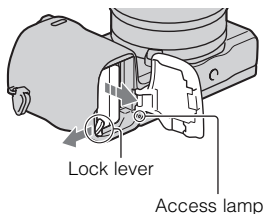

Attaching/removing the lens

Set the power switch of the camera to OFF before you attach or remove the lens.

- 1 If the cap or the packaging lid is attached, remove it from the camera or the lens.

- Quickly change the lens somewhere away from dusty locations so as to keep dust or debris from getting inside the camera.

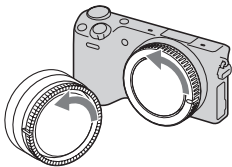

- 2 Mount the lens by aligning the white index marks on the lens and the camera.

- Hold the camera's face downward to prevent the dust from entering into the camera.

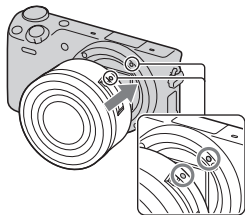

- 3 While pushing the lens lightly toward the camera, turn the lens clockwise until it clicks into the locked position.

- Be sure to put the lens on straight.

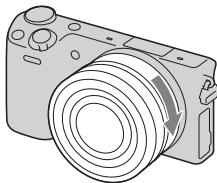

Notes

- When attaching a lens, do not press the lens release button.
- Do not use excessive force when attaching a lens.
- The Mount Adaptor (sold separately) is required to use an A-mount lens (sold separately). For details, refer to the operating manual supplied with the Mount Adaptor.
- When using a lens equipped with a tripod socket, attach the socket on the lens side to the tripod to maintain balance.

■ Removing the lens

- 1 Press the lens release button all the way in and turn the lens counterclockwise until it stops.

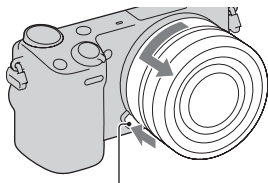

Lens release button

Notes

- If dust or debris gets inside the camera while you are changing the lens and adheres to the surface of the image sensor (the part that converts the light source to a digital signal), it may appear as dark spots on the image, depending on the shooting environment. The camera vibrates slightly when it is turned off, due to the anti-dust function, to prevent dust from adhering to the image sensor. However, attach or remove the lens quickly somewhere away from dusty locations.
- Do not leave the camera with the lens removed.
- When you want to use body caps or rear lens caps, please purchase ALC-BIEM (Body cap) or ALC-RIEM (Rear lens cap) (sold separately).
- When you use a lens with a power zoom, set the power switch of the camera to OFF and confirm that the lens is completely retracted before switching lenses. If the lens has not retracted, do not press the lens in by force.

Inserting a memory card (sold separately)

- 1 Open the cover.

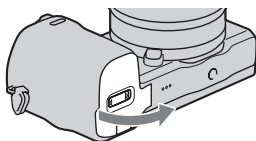

- 2 Insert a memory card.
- Insert the memory card until it clicks as illustrated.

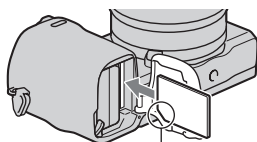

Check on the direction of the notched corner.

- 3 Close the cover.
-

Memory cards that you can use

You can use following types of memory cards with this camera. However, proper operation cannot be guaranteed for all types of the memory cards.

Usable memory card	Still image	Movie	Term in this manual
“Memory Stick PRO Duo” media	✓	✓ (Mark2)	“Memory Stick PRO Duo” media
“Memory Stick PRO-HG Duo” media	✓	✓	
SD memory card	✓	✓ (Class 4 or more)	SD card
SDHC memory card	✓	✓ (Class 4 or more)	
SDXC memory card	✓	✓ (Class 4 or more)	

You cannot use MultiMediaCard.

Notes

- Images recorded on an SDXC memory card cannot be imported to or played on computers or AV devices that are not compatible with exFAT. Make sure that the device is compatible with exFAT before connecting it to the camera. If you connect your camera to an incompatible device, you may be prompted to format the card. Never format the card in response to this prompt, as doing so will erase all data on the card. (exFAT is the file system used on SDXC memory cards.)

Removing the memory card

Open the cover, make sure that the access lamp is not lit, and push the memory card once.

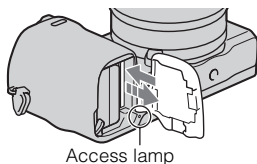

Notes

- When the access lamp is lit, do not remove the memory card or the battery pack, or turn off the power. The data may be corrupted.

Attaching the flash

When you want to use a flash during shooting, attach the flash device (supplied).

The flash is enabled when it is raised, and disabled when lowered.

Set the power switch of the camera to OFF before you attach or remove the flash.

- 1 Attach the flash to the Smart Accessory Terminal 2 of the camera.

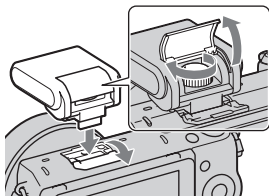

- 2 Fasten the screw to secure the flash.

- 3 Raise the flash first to fire the flash.

- Lower the flash when you do not intend to use it.
- The default setting is [Autoflash]. To change the setting, see page 54.

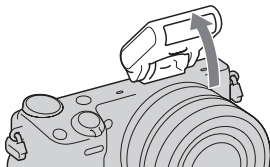

Notes

- The power for the flash is provided from the camera. When the camera is charging the flash,  blinks on the LCD screen. You cannot press the shutter button when this icon is blinking.
- Plug the flash fully into the Smart Accessory Terminal 2 of the camera, and fasten the screw securely. Make sure that the flash is attached to the camera securely.
- You cannot use the [Self-portrait Self-timer] function when a flash is attached to the camera.



Carrying the flash

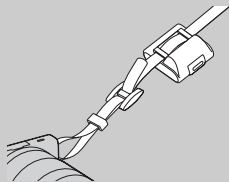

The flash case can be conveniently attached to the shoulder strap.

Store the flash in the case when you are not using it to protect it from harm.

Setting the date and time

When you turn on the camera for the first time, the screen to set date and time appears.

- 1 Set the power switch to ON to turn on the camera.

The screen to set date and time appears.

- To turn off the camera, set the power switch to OFF.

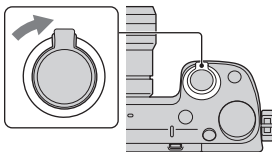

- 2 Press the center of the control wheel. Or, touch OK on the screen.

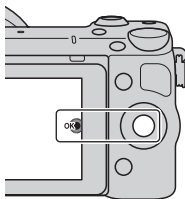

- 3 Select your area by pressing the right or left of the control wheel and press the center.

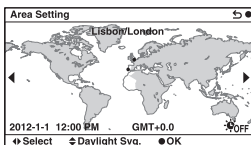

- 4 Press the left or right of the control wheel to select each item, and press the top or bottom, or turn it to select the numeric value.

Daylight Svg.: Turns on or off the daytime saving time setting.

Date Format: Selects the format to display date.

- Midnight is indicated as 12:00 AM, and noon as 12:00 PM.

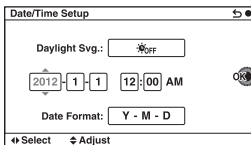

-
- 5** Repeat step 4 to set other items, and then press the center of the control wheel. Or, touch OK on the screen.
-

Notes

- You cannot set the date, time and area by touching the screen.
- You cannot superimpose the date on images on this camera. Using “PlayMemories Home” stored on the CD-ROM (supplied), you can save or print images with date. Refer to “PlayMemories Home Help Guide” for more details (page 73).

■ **Resetting the date and time/Checking the current clock setting**

Select MENU → [Setup] → [Date/Time Setup] (page 66).

■ **Maintaining the date and time setting**

This camera has an internal rechargeable battery for maintaining the date and time and other settings regardless of whether the power is on or off, or the battery is installed or not. For details, see page 96.

Shooting still images

In the **i** (Intelligent Auto) mode, the camera analyzes the subject, and allows you to shoot with appropriate settings.

- 1 Select MENU → [Shoot Mode] → **i** (Intelligent Auto).

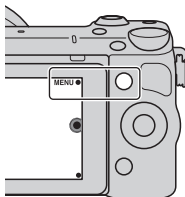

- 2 Point the camera to the subject.

When the camera recognizes the scene, the Scene Recognition icon and guide appear on the LCD screen:

- ☾ (Night Scene), 📵 (Tripod Night Scene), 🌙 (Night Portrait), 📷 (Backlight), 📷 (Backlight Portrait), 👤 (Portrait), 🏞️ (Landscape), 🌸 (Macro), 📖 (Spotlight), 📖 (Low Brightness), or 👶 (Baby).



Scene Recognition icon and guide

- 3 Adjust the zoom scale.

Lens with zooming lever: Slide the zooming lever.

Lens with zooming ring: Rotate the zooming ring.

- Optical zooming is not available with a fixed focus lens.
- When you operate the lens with power zoom, the camera shifts automatically to the [Zoom] feature of the camera when the magnification scale is greater than that of the optical zoom (page 53).

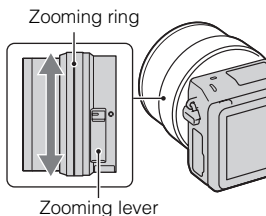

4 Press the shutter button halfway down to focus.

When the focus is confirmed, beeps sound and ● lights up.

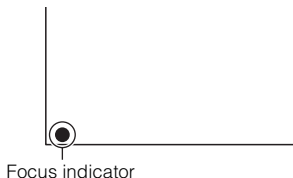
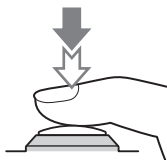

5 Press the shutter button fully down.

When the camera detects and shoots a face with [Auto Port. Framing] set to [Auto], the captured image is automatically trimmed into a suitable composition. Both the original and the trimmed images are saved.

■ Shooting still images using touch operation (Touch Shutter function)

The camera adjusts the focus and releases the shutter automatically when you simply touch the subject that you want to focus on the screen. You can use the Touch Shutter function when [Touch Shutter] is set to [On] in the MENU.

1 Touch on the screen.

- The icon changes to  and the touch shutter shooting becomes available.

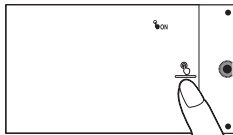

2 Point the camera to the subject, then touch the subject on the screen that you want to focus.

- The Auto Focus area is displayed on the screen where you touched it. When the focus is confirmed, the camera shoots an image automatically.

-
- 3 When you touch  on the screen, touch shutter shooting is canceled.
-

Recording movies

- 1 Point the camera to the subject.
-

- 2 Press the MOVIE button to start recording.

- Focus and brightness are adjusted automatically.
- If you press the shutter button halfway down during recording, you will be able to focus more quickly.

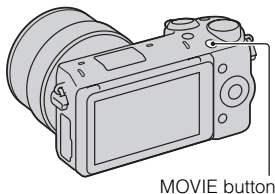

MOVIE button

- 3 Press the MOVIE button again to stop recording.
-

Notes

- The sound of the camera and the lens in operation might be recorded while recording a movie. You can disable the sound recording by selecting MENU → [Setup] → [Movie Audio Rec] → [Off] (page 66).
- The continuous recording time of a movie depends on the ambient temperature or the condition of the camera.
- When you are recording continuously for a long time, you may feel that the camera is warm. This is normal. Also, “Internal temp. high. Allow it to cool.” may appear. In such cases, turn the camera off and wait until the camera is ready to shoot again.

Playing back images

- 1 Press the  (Playback) button.

The last recorded image is displayed on the LCD screen.

- Press the center of the control wheel to enlarge the displayed image.

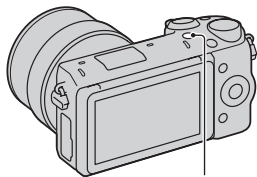

 (Playback) button

■ Selecting the image

Turn the control wheel. Or, slide your finger from left to right across the screen.



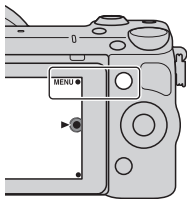

■ Playing back movies

- 1 Select MENU → [Playback] → [Still/Movie Select] → [Folder View(MP4)] or [AVCHD View].

- To return to still image playback, select [Folder View(Still)].





- 2 Turn the control wheel to select the desired movie, and press the center. Or, touch the desired movie.
-

During movie playback	Control wheel operation	Touch panel operation
Pause/resume	Press the center.	Touch  .
Fast-forward	Press the right, or turn the control wheel clockwise.	Touch  .
Fast-rewind	Press the left, or turn the control wheel counterclockwise.	Touch  .
Forward slow playback	Turn clockwise during pause.	Touch  during pause.
Reverse slow playback*	Turn counterclockwise during pause.	Touch  during pause.
Adjust sound volume	Press the bottom → top/bottom.	–

* The movie is played back frame-by-frame.

Deleting images

You can delete the image that is currently displayed.

- 1 Press  (Delete). Or, touch  on the screen.

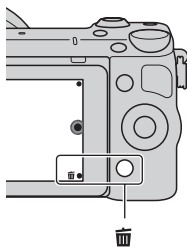

- 2 Press the center of the control wheel. Or, touch OK on the screen.

- Select  to quit the operation.

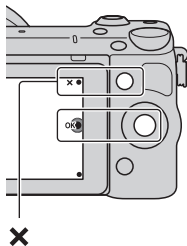





Deleting several images

Select MENU → [Playback] → [Delete] to select and delete several images at the same time.

Operating the camera

The control wheel, control dial, soft keys and touch panel allow you to use various functions of the camera.

Control wheel

When shooting, DISP (Display Contents),  (Exposure Comp.),  /  (Drive Mode) and ISO (ISO) functions are assigned to the control wheel. When playing back, DISP (Display Contents) and  (Image Index) functions are assigned to the control wheel.

When you turn or press the top/bottom/right/left parts of the control wheel following the on-screen display, you can select setting items. Your selection is determined when you press the center of the control wheel.

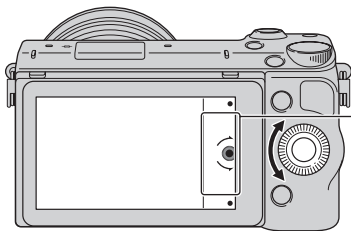

The arrow means you can turn the control wheel.

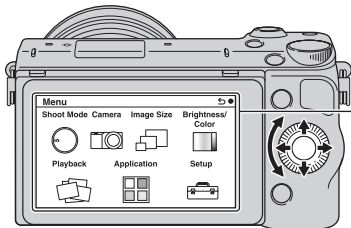

When options are displayed on the screen, you can browse through them by turning or pressing the top/bottom/left/right parts of the control wheel. Press the center to make your choice.

- The application downloading function may not be available in some countries/regions.

Control dial

You can set the aperture value and shutter speed, etc. by turning the control dial. The setting value assigned to the control dial changes for each shooting mode.

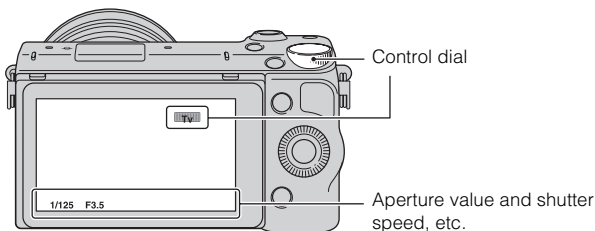

Soft keys

The soft keys have different roles, depending on the context.

The assigned role (function) of each soft key is shown on the screen.

To use the function shown at the upper right corner of the screen, press soft key A. To use the function shown at the lower right corner of the screen, press soft key B. To use the function shown at the center, press the center of the control wheel (soft key C).

In this manual, the soft keys are indicated by the icon or the function shown on the screen.

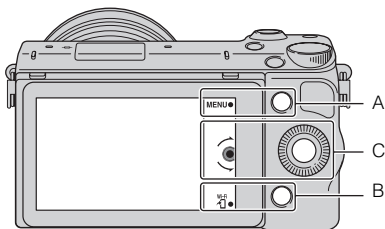

In this case, soft key A works as the MENU (Menu) button, and soft key B as the  (View on Smartphone) button.

Touch panel

You can operate the camera intuitively by touching the screen or sliding your finger across the screen. Touch the item to select it. Slide your finger across the screen to scroll down to hidden items.

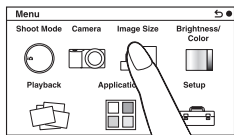

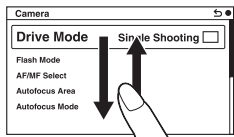

Touch the item to select it.



Sliding your finger across the screen scrolls the items. Items on the screen are replaced with items that were out of view.

Operations

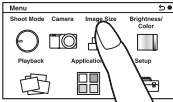
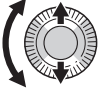
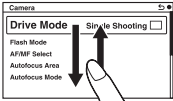
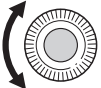
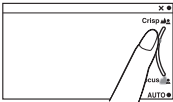
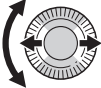
You can select items and make settings in two ways; by one is using the control wheel, or by the other is touching and sliding your finger across the screen (Touch panel).

Operation	Control wheel	Touch panel
Selecting an item	Turn or press the top/bottom/left/right parts of the control wheel, and then press the center. 	Touch the desired item. 
Displaying a hidden item	Keep turning or pressing the top/bottom parts of the control wheel until the item scrolls onto the screen. 	Slide your finger up or down across the screen until the item scrolls into view. 
Setting a value or adjusting the defocusing level	Turn the control wheel. 	Slide the indicator with your finger. 
Playing the next or the previous image	Turn the control wheel or press the left/right parts of the control wheel. 	Slide your finger left or right across the playback screen. 

Notes

- You can perform most operations using both the control wheel/soft keys and the touch panel. However, some operations can be performed only using one or the other.
- Avoid the followings when using the touch panel:
 - Using a pointed object, such as a pencil, ball-point pen, or the tip of a finger nail.
 - Operating the touch panel while the hand holding the camera is also touching the screen elsewhere.

Using the guide function of the camera

The camera provides various “Help Guides” which explain the functions, and “Shooting tips” which introduce tips for better shooting. Use these guides to make better use of the camera.

■ Help Guides

The camera displays the Help Guides to explain the selected function, when you change the setting, etc.

You can hide the Help Guides by selecting MENU → [Setup] → [Help Guide Display] → [Off].

■ Shooting tips

You can display shooting tips for better shooting from [Table of contents] by selecting MENU → [Camera] → [Shooting Tip List].

You can also assign [Shoot. Tips] to the soft key B.

Setting the function using [Photo Creativity]

You can operate the camera intuitively using [Photo Creativity], since the [Photo Creativity] screen is designed for more intuitive operations than a normal screen. You can shoot a subject with easy operations and obtain creative photos easily.

- 1 Select MENU → [Shoot Mode] → **i** (Intelligent Auto) or **i+** (Superior Auto).

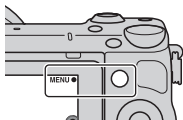



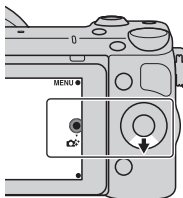

- 2 Press the bottom of the control wheel. Or, touch **cc+** (Photo Creativity) on the screen.

The [Photo Creativity] screen appears.



- 3 Select the item you want to adjust by touching the screen or by pressing the right/left of the control wheel.

-  **(Bkgground Defocus):** Adjusts the blurring of the background.
-  **(Brightness):** Adjusts the brightness.
-  **(Color):** Adjusts the color.
-  **(Vividness):** Adjusts the vividness.
-  **(Picture Effect):** Selects the desired effect filter for shooting.

- 4 Select the desired setting by turning the control wheel. Or, select the desired setting by touching the indicator or the item on the screen.

- Repeat Steps 3 – 4 to combine the various functions.

Notes

- [Photo Creativity] is only available when an E-mount lens is mounted.
- [Photo Creativity] is only available when [Intelligent Auto] or [Superior Auto] is selected.

Defocusing the background easily (Background Defocus Control)

1 Select  (Bkground Defocus) (page 41).

2 Defocus the background by turning the control wheel. Or, slide your finger along the indicator on the screen.

: You can focus on both the subject and the background.

: You can defocus the background.

- Select AUTO to restore the original status.
- You can record a movie with a value adjusted with the defocusing effect.

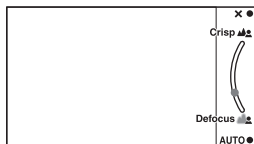

Notes

- The defocusing effect may not be noticeable, depending on the distance from the subject or the lens used.



Tips for a better result of Background Defocus

- Move closer to the subject.
- Lengthen the distance between the subject and the background.

Picture Effect

1 Select  (Picture Effect) (page 41).

2 Select the desired effect by turning the control wheel. Or, slide your finger across the screen upward or downward to select the desired effect.

 **(Off):** Disables the Picture Effect function.

 **(Toy Camera):** Creates the look of a Toy Camera photo with shaded corners and pronounced colors.





 **(Pop Color):** Creates a vivid look by emphasizing color tones.

 **(Posterization: Color):** Creates a high contrast, abstract look by heavily emphasizing primary colors.

 **(Posterization: B/W):** Creates a high contrast, abstract look in black and white.

 **(Retro Photo):** Creates the look of an aged photo with sepia color tones and faded contrast.

 **(Soft High-key):** Creates an image with the indicated atmosphere: bright, transparent, ethereal, tender, soft.

    **(Partial Color):** Creates an image which retains the specified color, but converts others to black and white.

 **(High Contrast Mono.):** Creates an image with high contrast in black and white.

- You can use more picture effects. Select MENU → [Brightness/ Color] → [Picture Effect].
-

Adjusting the brightness of still images (Exposure compensation)

You can adjust the exposure in 1/3 EV steps in a range of -3.0 EV to +3.0 EV.

- 1 Press  (Exposure Comp.) on the control wheel.

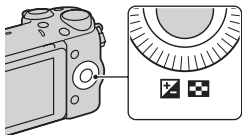



- 2 Turn the control wheel or control dial to select the desired value, and press the center.
Or, select the desired value by sliding your finger along the indicator on the screen.
 - When the image is too bright, set [Exposure Comp.] toward -.
 - When the image is too dark, set [Exposure Comp.] toward +.

Using the self-timer

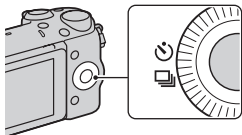
- 1 Press  (Drive Mode) on the control wheel.



- 2 Turn the control wheel to select  (Self-timer).
Or, slide your finger across the screen upward or downward to move  (Self-timer) to the center of the screen.

3 Press **OPTION**, and then turn the control wheel to select the desired mode and press the center.

Or, touch **OPTION** → desired mode on the screen.

☺₁₀ (Self-timer: 10 Sec): Sets the 10-second delay self-timer. Use this when you want to include yourself in the picture.

When you press the shutter button, the self-timer lamp flashes and beeps until the shutter operates.

☺₂ (Self-timer: 2 Sec): Sets the 2-second delay self-timer. You can prevent blur caused by camera-shake that occurs when the shutter button is pressed.

- To cancel the timer, press **☺ / 📷** (Drive Mode) again.
- When using the touch shutter, a beep sounds if the subject that you touch on the screen is in focus, then the countdown begins.



Shooting continuously using the self-timer

Select **☺** (Self-timer(Cont)) from **☺ / 📷** (Drive Mode). The camera starts continuous recording after 10 seconds.

Shooting still images continuously

The camera records images continuously while you are pressing and holding down the shutter button or while you are touching the screen.

1 Press **☺ / 📷** (Drive Mode) on the control wheel.

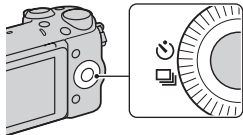



2 Turn the control wheel to select **📷** (Cont. Shooting), and press the center.

Or, slide your finger across the screen upward or downward to move **📷** (Cont. Shooting) to the center of the screen, then touch **📷** (Cont. Shooting).



Shooting continuously at a higher speed

Select  (Spd Priority Cont.) from  /  (Drive Mode) to shoot continuously at higher speed (max. 10 images per second).

Changing the screen display (DISP)

- 1 Press DISP (Display Contents) on the control wheel.

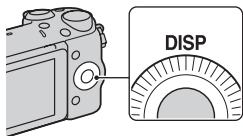

- 2 Press DISP repeatedly to select the desired mode.

During shooting

Graphic Display: Shows basic shooting information. Graphically shows the shutter speed and aperture value, except for when [Shoot Mode] is set to [Sweep Panorama].

Display All Info.: Shows recording information.

Big Font Size Disp.: Shows only major items in a larger size.

No Disp. Info.: Does not show recording information.

Level: Displays an indicator guide showing the angle of inclination of the camera to the front, back, left or right side.

Histogram: Displays the luminance distribution graphically.

For viewfinder: Shows only shooting information on the screen (no image). Select this mode when you shoot using a viewfinder (sold separately).

During playback

Display Info.: Shows recording information.

Histogram: Displays the luminance distribution graphically, in addition to recording information.

No Disp. Info.: Does not show recording information.

Shooting with various shooting modes

- 1 Select MENU → [Shoot Mode].

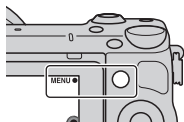

- 2 Turn the control wheel to select the desired mode, and press the center.
Or, slide your finger across the screen upward or downward to move the desired mode to the center of the screen, then touch the desired mode.

i (Intelligent Auto): The camera evaluates the subject and makes the proper settings.

SCN (Scene Selection): Shoots with preset settings according to the subject or condition.

☐ (Sweep Panorama): Shoots with panoramic size.

M (Manual Exposure): Adjusts the aperture and shutter speed.

S (Shutter Priority): Adjusts the shutter speed to express the movement of the subject.

A (Aperture Priority): Adjusts the range in focus, or defocuses the background.

P (Program Auto): Automatic shooting that allows you to customize settings, except for the exposure (shutter speed and aperture).

i+ (Superior Auto): Shoots images with a wider range of shooting functions than those of Intelligent Auto shooting. Recognizes and evaluates the shooting conditions automatically, performs Auto HDR, and chooses the best image.

■ Scene Selection

1 Select **SCN** (Scene Selection) (page 47).

2 Turn the control wheel to select the desired mode, and press the center.

Or, slide your finger across the screen upward or downward to move the desired mode to the center of the screen, then touch the desired mode.

- You can select another Scene Selection mode by turning the control dial.

 **(Portrait)**: Blurs away backgrounds and sharpens the subject. Accentuate skin tones softly.

 **(Landscape)**: Shoots the entire range of scenery in sharp focus with vivid colors.

 **(Macro)**: Shoots close-ups of the subjects such as flowers, insects, food, or small items.

 **(Sports Action)**: Shoots a moving subject at a fast shutter speed so that the subject looks as if it is standing still. The camera shoots images continuously while the shutter button is pressed. When using the touch shutter, the camera shoots images continuously while you are touching the screen.

 **(Sunset)**: Shoots the red of the sunset beautifully.

 **(Night Portrait)**: Shoots portraits in night scenes. Raise the flash to use this mode.

 **(Night Scene)***: Shoots night scenes without losing the dark atmosphere.

 **(Hand-held Twilight)**: Shoots night scenes with less noise and blur without using a tripod. A burst of shots are taken, and image processing is applied to reduce subject blur, camera-shake, and noise.

 **(Anti Motion Blur)**: Allows you to shoot indoor shots without using the flash and reduces subject blur. The camera shoots burst images and combines them to create the image, reducing subject blur and noise.

* You cannot record images when using touch shutter.

■ Sweep Panorama

While you pan the camera, the camera shoots several images and composes them into one panoramic image.

- 1 Set the shooting mode to  (Sweep Panorama) (page 47).
- 2 Select the shooting direction by turning the control dial.

- 3 Point the camera at the subject for which you want to set the brightness and focus, and then press the shutter button halfway down.



This part will not be taken.

- 4 Keep the shutter button pressed halfway down and point the camera at the edge of the subject, and then press the shutter button fully down.
- 5 Pan the camera to the end, following the guidance on the LCD screen.



Guidance bar

Notes

- The camera shoots continuously during [Sweep Panorama] recording, and the shutter continues to click until shooting is finished.
- You cannot record images when using touch shutter.



Playing back scrolling panoramic images

You can scroll panoramic images from the beginning to the end by pressing the center of the control wheel while panoramic images are being displayed. Press the center of the control wheel again to pause. You can scroll/pause by touching ►/|| on the screen.





This indicator shows the displayed area of the whole panoramic image.

- Panoramic images shot with other cameras may not be displayed or scrolled correctly.

■ Shutter Priority

You can express the movement of a moving subject in various ways by adjusting the shutter speed, for example, at the instant of the movement with high speed shutter, or as a trailing image with low speed shutter.

-
- 1 Select **S** (Shutter Priority) (page 47).
-
- 2 Turn the control dial to select the desired value.
Or, touch  /  on the screen to select the desired value.
-



Shutter speed





When a faster shutter speed is used, a moving subject such as a running person, cars, and sea spray appears as if they are stopped.



When a slower shutter speed is used, a trailing image of the movement of the subject is captured to make more natural and dynamic image.

■ Aperture Priority

You can adjust the range in focus, or defocuses the background.

- 1 Select **A** (Aperture Priority) (page 47).
- 2 Turn the control dial to select the desired value.
Or, touch  /  on the screen to select the desired value.
 - You can record a movie with a value adjusted with [Aperture Priority].

■ Program Auto/Superior Auto

In [Superior Auto] mode, the camera shoots with higher quality than [Intelligent Auto] mode and perform composite shooting as necessary.

In [Program Auto] mode, you can shoot after adjusting various functions, such as white balance, ISO, etc.

1 Select **P** (Program Auto) or **i**+ (Superior Auto) (page 47).

2 Point the camera to the subject, focus on the subject, and then record an image.

Shooting mode	Your purpose
i (Intelligent Auto)	<ul style="list-style-type: none">• Select this mode to easily recognize the scene and shoot continuous images.
P (Program Auto)	<ul style="list-style-type: none">• Select this mode to shoot with various functions other than the exposure (shutter speed and aperture) adjusted.
i + (Superior Auto)	<ul style="list-style-type: none">• Select this mode to shoot scenes under difficult circumstances, such as when you have dark scenes, or back-lit subjects.• Select this mode to shoot a higher quality image than that offered by [Intelligent Auto].

Notes

- In [Superior Auto] mode, the recording process takes longer, since the camera must make a composite image.

Zooming

With the [Zoom] feature of the camera, you can increase the magnification to a scale greater than that of the optical zoom scale of the lens.

When using a lens with a power zoom, operate the optical zoom of the lens and then the camera shifts automatically to the [Zoom] feature of the camera.

When using a lens that is not equipped with a power zoom, follow the instruction below after magnifying using the optical zoom.

- 1 Select MENU → [Camera] → [Zoom] → desired value.

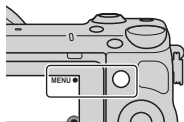

The [Zoom] features available with this camera

The [Zoom] feature of the camera provides higher magnification by combining various zoom features. The icon displayed on the LCD screen changes as follows, according to the selected zoom feature.



- ① **Q** : The [Zoom] feature of the camera is not used. (×1.0 is indicated.)
- ② **sQ** Smart Zoom: You can magnify images by trimming them partially. (Available only when [Image Size] is set to [M] or [S].)
- ③ **cQ** Clear Image Zoom: You can magnify images using high-resolution image processing.
- ④ **dQ** Digital Zoom: You can magnify images using image processing. (The default setting is [Off].)

Selecting the flash mode

1 Attach the flash and raise it (page 26).

2 Select MENU → [Camera] →
[Flash Mode].

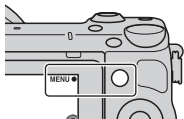



3 Turn the control wheel to select the desired mode, and press the center.

Or, slide your finger across the screen upward or downward to move the desired mode to the center of the screen, then touch the desired mode.

 **(Flash Off):** Does not fire even if the flash is raised.

 **(Autoflash):** Fires in dark environments or when shooting towards bright light.

 **(Fill-flash):** Fires every time you trigger the shutter.

 **(Slow Sync.):** Fires every time you trigger the shutter. Slow sync shooting allows you to shoot a clear image of both the subject and the background.

 **(Rear Sync.):** Fires right before the exposure is completed every time you trigger the shutter. A trailing image of the movement of the subject is captured to make more natural image.

- The selectable items of the flash mode depends on the shooting mode (page 70).
-

Notes

- When the camera is charging the flash,  blinks on the LCD screen. You cannot press the shutter button when this icon is blinking.

The flash range

The range of the flash depends on the ISO sensitivity and aperture value.

	F2.8	F3.5	F5.6
ISO100	1 m – 2.5 m (3.3 feet – 8.2 feet)	1 m – 2 m (3.3 feet – 6.6 feet)	1 m – 1.25 m (3.3 feet – 4.1 feet)
ISO3200	5.6 m – 14 m (18.3 feet – 46 feet)	4.5 m – 11.2 m (14.7 feet – 36.7 feet)	2.8 m – 7 m (9.1 feet – 22.9 feet)

Setting using the Fn (Function) button

- 1 Press the Fn (Function) button.

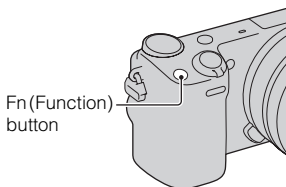



- 2 Select a desired function by pressing the right/left side of the control wheel. Or, touch the desired setting.
- 3 Turn the control wheel to select the desired settings. Or, touch the desired function to change.



How to assign other functions to the Fn (Function) button

The following functions are assigned to the Fn (Function) button by the default settings.

Focus (AF/MF Select)/**AF MODE** (Autofocus Mode)/ (Autofocus Area)/**WB** (White Balance)/ (Metering Mode)/ (Picture Effect)

You can change the functions assigned to the Fn (Function) button by selecting MENU → [Setup] → [Function Menu Settings].

Selecting the image size/record setting

The image size determines the size of the image file that is recorded when you take an image. The larger the image size, the more detail will be reproduced when the image is printed on large format paper. The smaller the image size, the more images can be recorded. In the case of movies, the larger the bit-rate, the higher the image quality.

1 Select MENU → [Image Size] → [Image Size]. For movie recording, select MENU → [Image Size] → [Record Setting].

2 Select the desired mode.

Movie

[File Format]: [AVCHD]	Bit-rate	Recording
60i 24M(FX)* 50i 24M(FX)**	Maximum 24 Mbps	Records high image quality movies of 1920 × 1080 (60i/50i).
✓ 60i 17M(FH)* 50i 17M(FH)**	Average 17 Mbps	Records standard image quality movies of 1920 × 1080 (60i/50i).
60p 28M(PS)* 50p 28M(PS)**	Maximum 28 Mbps	Records highest image quality movies of 1920 × 1080 (60p/50p).
24p 24M(FX)* 25p 24M(FX)**	Maximum 24 Mbps	Records high image quality movies of 1920 × 1080 (24p/25p). This produces a cinema-like atmosphere.
24p 17M(FH)* 25p 17M(FH)**	Average 17 Mbps	Records standard image quality movies of 1920 × 1080 (24p/25p). This produces a cinema-like atmosphere.
[File Format]: [MP4]	Bit-rate	Recording
✓ 1440×1080 12M	Average 12 Mbps	Records movies of 1440 × 1080.
VGA 3M	Average 3 Mbps	Records movies of VGA size.

* 1080 60i-compatible device

** 1080 50i-compatible device

Notes

- When you print still images recorded with 16:9 aspect ratio, and panoramic images, both edges may be cut off.

Displaying the image list

- 1 Press the  (Playback) button to enter playback mode.

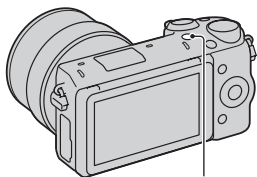

 (Playback) button

- 2 Press  (Image Index) on the control wheel.
Six images are displayed at a time.

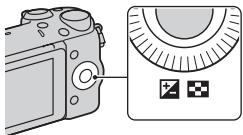

- 3 Turn the control wheel to select an image.
Or, touch the desired image.

- To return to the single-image screen, select the desired image, and press the center.
- You can browse images quickly by sliding your finger across the screen upward and downward.



Displaying a desired folder

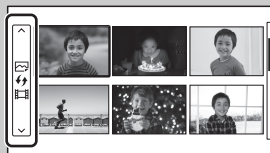

To select a desired folder, select the bar on the left of the image index screen, and then press the top/bottom parts of the control wheel. You can switch between still image playback and movie playback by pressing the center of the control wheel. You can also select a folder by touching the bar on the left. You can switch between still image playback and movie playback by touching the center of the bar.

Viewing images on a TV

To view images on the camera using a TV, an HDMI cable (sold separately) and an HD TV equipped with an HDMI connector are required.

- 1 Connect the camera to the TV with an HDMI cable (sold separately).

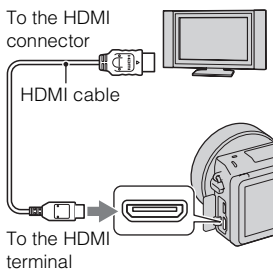

Notes

- Use an HDMI mini connector on one end (for the camera), and a plug suitable for connecting your TV on the other end.



Using your camera abroad

To view movies shot using this camera on a TV, the camera and TV must use the same color television system.

Menu list

When you press MENU, the menu items [Shoot Mode], [Camera], [Image Size], [Brightness/Color], [Playback], [Application]* and [Setup] appear on the screen.

You can set various functions in each item. Items that cannot be set in the context are displayed in gray.

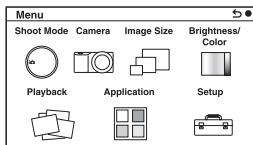

* The application downloading function may not be available in some countries/regions.

Shoot Mode

Allows you to select a shooting mode, such as exposure mode, panoramic, Scene Selection.

Superior Auto	Shoots images with a wider range of shooting functions than those of Intelligent Auto shooting. Recognizes and evaluates the shooting conditions automatically, performs Auto HDR, and chooses the best image.
Intelligent Auto	The camera evaluates the subject and makes the proper settings.
Scene Selection	Shoots with preset settings according to the subject or condition. (Portrait/Landscape/Macro/Sports Action/Sunset/Night Portrait/Night Scene/Hand-held Twilight/Anti Motion Blur)
Sweep Panorama	Shoots with panoramic size.
Manual Exposure	Adjusts the aperture and shutter speed.
Shutter Priority	Adjusts the shutter speed to express the movement of the subject.
Aperture Priority	Adjusts the range in focus, or defocuses the background.

Program Auto	Automatic shooting that allows you to customize settings, except for the exposure (shutter speed and aperture).
--------------	---

■ Camera

Allows you to set shooting functions, such as continuous shooting, self-timer, and flash.

Drive Mode	Selects the drive mode, such as continuous shooting, self-timer, or bracket shooting. (Single Shooting/Cont. Shooting/Spd Priority Cont./Self-timer/Self-timer(Cont)/Bracket: Cont./Remote Cdr.)
Flash Mode	Selects the method used to fire the flash. (Flash Off/Autoflash/Fill-flash/Slow Sync./Rear Sync.)
AF/MF Select	Selects auto focusing or manual focusing. (Autofocus/DMF/Manual Focus)
Autofocus Area	Selects the area to be focused on. (Multi/Center/Flexible Spot)
Autofocus Mode	Selects the autofocus method. (Single-shot AF/Continuous AF)
Touch Shutter	Sets whether to use the touch shutter function. (On/Off)
Object Tracking	Keeps the focus on a subject while tracking it.
Zoom	Sets the zoom scale of the [Zoom] feature of the camera.
Face Detection	Detects people's faces automatically, and adjusts focus and exposure to suit the faces. (On (Regist. Faces)/On/Off)
Face Registration	Registers or changes the person to be given priority in the focus. (New Registration/Order Exchanging/Delete/Delete All)
Smile Shutter	Each time the camera detects a smile, the camera releases the shutter automatically. (Off/On)
Auto Port. Framing	Analyzes the scene when capturing a face and saves another image with a more impressive composition. (Off/Auto)

Soft Skin Effect	Shoots the skin smoothly in the Face Detection function. (On/Off)
Shooting Tip List	Allows you to access all shooting tips.
LCD Display (DISP)	Switches the information to be displayed on the shooting screen on the LCD screen. (Graphic Display/Display All Info./Big Font Size Disp./No Disp. Info./Level/Histogram/For viewfinder)
Finder Display(DISP)	Changes the information to be displayed on an Electronic Viewfinder (sold separately). (Disp. Basic Info./Level/Histogram)
DISP Button(Monitor)	Sets the screen display modes to be displayed on the LCD screen by pressing the DISP button. (Graphic Display/Display All Info./Big Font Size Disp./No Disp. Info./Level/Histogram/For viewfinder)

■ Image Size

Allows you to set the image size and aspect ratio, etc.

Still	
Image Size	Selects the image size. (3:2: L: 16M/ M: 8.4M/ S: 4.0M) (16:9: L: 14M/ M: 7.1M/ S: 3.4M)
Aspect Ratio	Selects the aspect ratio. (3:2/16:9)
Quality	Selects the compression format. (RAW/RAW & JPEG/Fine/Standard)
Panorama	
Image Size	Selects the image size. (Standard/Wide)
Panorama Direction	Selects the direction to pan the camera when shooting panoramic images. (Right/Left/Up/Down)

Movie	
File Format	Selects AVCHD or MP4.
Record Setting	Selects the image size, frame rate, and image quality of movies. (AVCHD: 60i/50i 24M (FX) / 60i/50i 17M (FH) / 60p/50p 28M (PS) / 24p/25p 24M (FX) / 24p/25p 17M (FH)) (MP4: 1440×1080 12M/VGA 3M)

■ Brightness/Color

Allows you to make brightness settings such as metering mode, and color settings such as white balance.

Exposure Comp.	Compensates for the brightness of the entire image. (-3.0EV to +3.0EV)
ISO	Sets the ISO sensitivity. (ISO AUTO/100 - 25600)
White Balance	Adjusts the color tones according to the ambient light conditions. (Auto WB/Daylight/Shade/Cloudy/Incandescent/Fluor.: Warm White/Fluor.: Cool White/Fluor.: Day White/Fluor.: Daylight/Flash/C.Temp./Filter/Custom/Custom Setup)
Metering Mode	Selects the method used for measuring the brightness. (Multi/Center/Spot)
Flash Comp.	Adjusts the amount of flash light. (-2.0EV to +2.0EV)
DRO/Auto HDR	Corrects the brightness or contrast automatically. (Off/D-Range Opt./Auto HDR)
Picture Effect	Shoots with the desired effects to express a unique atmosphere. (Off/Toy Camera/Pop Color/Posterization/Retro Photo/Soft High-key/Partial Color/High Contrast Mono./Soft Focus/HDR Painting/Rich-tone Mono./Miniature)
Creative Style	Selects the image processing method. (Standard/Vivid/Portrait/Landscape/Sunset/Black & White)

■ Playback

Allows you to set playback functions.

Delete	Deletes images. (Multiple Img./All in Folder/All AVCHD view files)
Still/Movie Select	Allows you to determine how to group the playback images (View mode). (Folder View(Still)/Folder View(MP4)/AVCHD View)
Slide Show	Plays back images automatically. (Repeat/Interval/Image Type)
View on Smartphone	Transfers the images to a Smartphone and displays them. (This Image/All Images on This Date/All Images in The Device)
Send to Computer	Transfers the images to a computer that is connected to the network for backup.
View on TV	Transfers the images to a TV that is connected to the network for viewing.
Specify Printing	Selects the images to print, or makes printing settings. (DPOF Setup/Date Imprint)
Image Index	Selects the number of images to be displayed on the index screen. (6 Images/12 Images)
⊕ Enlarge Image	Enlarges the image.
Rotate	Rotates images.
Protect	Protects images, or cancels the protection. (Multiple Img./Cancel All Images/Cancel All Movies(MP4)/Cancel All AVCHD view files)
Volume Settings	Sets the sound volume of movies.
Display Contents	Switches the information to be displayed on the playback screen. (Display Info./Histogram/No Disp. Info.)

■ Application

You can add the desired functions to your camera by connecting to the application downloading website “PlayMemories Camera Apps” via the Internet.

■ Setup

Allows you to make more detailed shooting settings, or change the camera settings.

Shooting Settings	
AEL w/ shutter	Sets whether or not to fix the exposure when you press the shutter button halfway down. (On/Off)
AF Illuminator	Sets the AF illuminator to assist auto-focusing in dim places. (Auto/Off)
Phase Detection AF Area	Sets whether to display the Phase Detection AF ranging points on the screen. (On/Off)
Red Eye Reduction	Provides pre-flash before shooting when using the flash, to prevent eyes from being shot in red. (On/Off)
FINDER/LCD Setting	Sets how to switch between an Electronic Viewfinder (sold separately) and the LCD screen. (Auto/Viewfinder/Manual)
Live View Display	Allows you to choose whether or not to show the value of exposure compensation, etc. on the screen display. (Setting Effect ON/Setting Effect OFF)
Auto Review	Sets the display time of the image right after shooting. (10 Sec/5 Sec/2 Sec/Off)
Grid Line	Turns on the grid line that helps you to adjust the composition of images. (Rule of 3rds Grid/Square Grid/Diag. + Square Grid/Off)
Peaking Level	Enhances the outline of in-focus ranges with a specific color. (High/Mid/Low/Off)
Peaking Color	Sets the color used for the peaking function. (White/Red/Yellow)
Clear Image Zoom	Zooms an image with higher quality than Digital Zoom. (On/Off)

Digital Zoom	Zooms an image with higher magnification than Clear Image Zoom. This feature can be also available in movie recording. (On/Off)
Self-portrait Self-timer	Sets the shooting mode when the LCD screen is tilted upward about 180 degrees. When you set [Self-portrait Self-timer] to [On], a 3-second delay self-timer is activated, and you can reduce the camera-shake when shooting self-portrait. (On/Off)
S. Auto Image Extract.	Sets whether or not to save all the images that were shot continuously in Superior Auto mode. (Auto/Off)
MF Assist	Displays an enlarged image when focusing manually. (On/Off)
MF Assist Time	Sets the length of time the image will be shown in an enlarged form. (No Limit/5 Sec/2 Sec)
Color Space	Changes the range of color reproduction. (sRGB/AdobeRGB)
SteadyShot	Sets camera-shake compensation. (On/Off)
Release w/o Lens	Sets whether or not to release the shutter when there is no lens. (Enable/Disable)
Eye-Start AF	Sets whether or not to use autofocus when you look through an Electronic Viewfinder (sold separately) with the LA-EA2 Mount Adaptor attached (sold separately). (On/Off)
Front Curtain Shutter	Sets whether or not to use the electronic front curtain shutter function. (On/Off)
Long Exposure NR	Sets the noise reduction processing for long exposure shootings. (On/Off)
High ISO NR	Sets the noise reduction processing for high ISO sensitivity shootings. (Normal/Low)
Lens Comp.: Shading	Compensates for the shaded corners of the screen. (Auto/Off)

Lens Comp.: Chro. Aber.	Reduces the color deviation at the corners of the screen. (Auto/Off)
Lens Comp.: Distortion	Compensates for distortion on the screen. (Auto/Off)
Face Priority Tracking	Sets whether to preferentially-track a certain face or not when the camera detects that face during object tracking. (On/Off)
Auto Slow Shutter	Sets whether or not to adjust the shutter speed automatically when recording movies if the subject is dark. (On/Off)
Movie Audio Rec	Sets whether or not to record sound when recording a movie. (On/Off)
Wind Noise Reduct.	Reduces wind noise during movie recording. (On/Off)
AF Micro Adj.	Finely adjusts the autofocused position, when using the LA-EA2 Mount Adaptor (sold separately). (AF Adjustment Setting/amount/Clear)
Main Settings	
Menu start	Selects a first-displayed menu from the top menu or the last menu screen. (Top/Previous)
Function Menu Settings	Assigns functions to the Fn (Function) button.
MOVIE Button	Sets whether or not to activate the MOVIE button. (On/Off)
Custom Key Settings	Assigns functions to the Soft keys.
Touch Operation	Sets whether or not to operate the camera using the touch panel. (On/Off)
Beep	Selects the sound produced when you operate the camera. (On/Off)
 Language	Selects the language used on the screen.
Date/Time Setup	Sets the date and time.
Area Setting	Selects the area where you are using the camera.

Help Guide Display	Turns the Help Guide on or off. (On/Off)
Power Save	Sets the level of the power saving feature. (Max/Standard)
Power Saving Start Time	Sets the time to turn the camera to the power save mode. (30 Min/5 Min/1 Min/20 Sec/10 Sec)
LCD Brightness	Sets the brightness of the LCD screen. (Manual/Sunny Weather)
Viewfinder Bright.	Sets the brightness of an Electronic Viewfinder (sold separately). (Auto/Manual)
Display Color	Selects the color of the LCD screen. (Black/White/Blue/Pink)
Wide Image	Selects a method to display wide images. (Full Screen/Normal)
Playback Display	Selects the method used to play back portrait images. (Auto Rotate/Manual Rotate)
HDMI Resolution	Set resolution when connected to HDMI TV. (Auto/1080p/1080i)
CTRL FOR HDMI	Sets whether or not to operate the camera with a “BRAVIA” Sync-compliant TV’s Remote Control. (On/Off)
USB Connection	Selects the appropriate USB connection method for each computer or USB device connected to the camera. (Auto/Mass Storage/MTP)
Cleaning Mode	Allows you to clean the image sensor.
Calibration	Enables you to perform calibration when the touch panel buttons do not react at the appropriate points where you touch.
Version	Displays the version of the camera and the lens.
Demo Mode	Sets whether or not to display the demonstration with movies. (On/Off)
Initialize	Resets the camera to the default settings. (Reset Default/Factory Reset)

Memory Card Tool	
Format	Formats the memory card.
File Number	Selects the method to use to assign file numbers to still images and MP4 movies. (Series/Reset)
Folder Name	Selects the folder name format in which the still image is stored. (Standard Form/Date Form)
Select Shoot. Folder	Selects the recording folder to which still images and MP4 movies are recorded.
New Folder	Creates a new folder to which still images and MP4 movies are recorded.
Recover Image DB	Repairs the image database file when inconsistencies are found.
Display Card Space	Displays the remaining recording time of movies and the recordable number of still images on the memory card.
Eye-Fi Setup*	
Upload Settings	Sets whether to use the upload function of the camera with an Eye-Fi card. (On/Off)
Network Settings	
WPS Push	You can register the access point to the camera easily by pushing the WPS button.
Access Point Settings	You can register your access point manually.
Edit Device Name	You can change the device name under Wi-Fi Direct.
Disp MAC Address	Displays the MAC address of the camera.
Reset View on Smartphone	Resets the connecting information for [View on Smartphone].
Reset Network Settings	Resets all the network settings to default settings.

* This setting appears when an Eye-Fi card is inserted in the camera. Do not use an Eye-Fi card inserted in the camera on an airplane. If an Eye-Fi card is inserted in the camera, set [Upload Settings] to [Off].













Eye-Fi cards can be used only in the countries/regions where they were purchased. Use Eye-Fi cards in accordance with the law of the countries/regions where you purchased the card.

Functions available for each shooting mode

The functions you can use depend on the selected shooting mode.

In the table below, ✓ indicates the function is available, and a – indicates the function is not available.

The functions you cannot use are displayed in gray on the screen.

Shoot Mode		Exposure Comp.	Self-timer	Cont. Shooting	Face Detection	Picture Effect
 (Intelligent Auto)		–	✓	✓	✓	–
SCN (Scene Selection)		–	✓	–	✓	–
		–	✓	✓	✓	–
		–	✓	–	✓	–
		–	✓	–	✓	–
		–	✓	–	✓	–
		–	✓	–	✓	–
		–	–	–	✓	–
		–	✓	–	✓	–
	–	–	–	✓	–	
 (Sweep Panorama)		✓	–	–	–	–
M (Manual Exposure)		–	✓	✓	✓	✓
S (Shutter Priority)		✓	✓	✓	✓	✓
A (Aperture Priority)		✓	✓	✓	✓	✓
P (Program Auto)		✓	✓	✓	✓	✓
 (Superior Auto)		–	✓	✓	✓	–

Notes

- The functions available may be limited also by conditions other than the shooting mode.

Flash modes available

The flash modes you can select depend on the shooting mode and functions selected.

In the table below, ✓ indicates the function is available, and a – indicates the function is not available.

The flash modes you cannot select are displayed in gray on the screen.

Shoot Mode	Flash Off	Autoflash	Fill-flash	Slow Sync.	Rear Sync.	
 (Intelligent Auto)	✓	✓	✓	–	–	
SCN (Scene Selection)		✓	✓	✓	–	–
		✓	–	✓	–	–
		✓	✓	✓	–	–
		✓	–	✓	–	–
		✓	–	✓	–	–
		✓	–	–	–	–
		✓	–	–	–	–
		–	✓*	–	–	–
	✓	–	–	–	–	
 (Sweep Panorama)	✓	–	–	–	–	
M (Manual Exposure)	–	–	✓	✓	✓	
S (Shutter Priority)	–	–	✓	✓	✓	
A (Aperture Priority)	–	–	✓	✓	✓	
P (Program Auto)	–	–	✓	✓	✓	
 (Superior Auto)	✓	✓	✓	–	–	

* The camera emits flash light in slow synchro mode if the flash is necessary.

Notes

- The flash modes may be limited also by conditions other than the shooting mode.
- Even if you select a workable flash mode, the flash does not fire unless it is raised.

Installing the software

To utilize images recorded with the camera, the following software is provided with CD-ROM (supplied):

- “Image Data Converter”
You can open RAW format image files.
- “PlayMemories Home” (Windows only)
You can import still images or movies recorded with the camera to your computer so that you can view them, and use various convenient features to enhance the images you have shot.

Notes

- Log on as Administrator.
- Use “Image Data Converter” to play back RAW images.
- If “PMB” (Picture Motion Browser) supplied with a camera that was purchased before 2011 has already been installed on the computer, “PMB” will be overwritten by “PlayMemories Home,” and you may be unable to use some functions of “PMB” that were previously available.
- “PlayMemories Home” is not compatible with Mac computers. When you play back images on Mac computers, use the appropriate application software supplied with the Mac computer.

Windows

The following computer environment is recommended when using the supplied software and importing images via a USB connection.

OS (pre-installed)	Microsoft Windows XP* SP3/Windows Vista** SP2/ Windows 7 SP1
“PlayMemories Home”	CPU: Intel Pentium III 800 MHz or faster For playing/editing the High Definition movies: Intel Core Duo 1.66 GHz or faster/Intel Core 2 Duo 1.66 GHz or faster (Intel Core 2 Duo 2.26 GHz or faster (AVC HD (FX/FH)), Intel Core 2 Duo 2.40 GHz or faster (AVC HD PS)) Memory: Windows XP 512 MB or more (1 GB or more is recommended), Windows Vista/Windows 7 1 GB or more Hard Disk: Disk space required for installation—approximately 500 MB Display: Screen resolution—1024 × 768 dots or more
“Image Data Converter Ver.4”	CPU/Memory: Pentium 4 or faster/1 GB or more Display: 1024 × 768 dots or more

* 64-bit editions and Starter (Edition) are not supported. Windows Image Mastering API (IMAPI) Ver. 2.0 or later is required to use the function for creating discs.

** Starter (Edition) is not supported.

1 Turn on your computer, and insert the CD-ROM (supplied) into the CD-ROM drive.

The installation menu screen appears.

- If the installation menu does not appear, double-click [Computer] (For Windows XP: [My Computer]) →  (PMHOME) → [Install.exe].
 - If the AutoPlay screen appears, select “Run Install.exe” and follow the instructions that appear on the screen to proceed with the installation.
-

2 Connect the camera to the computer.

3 Click [Install].

- Make sure that both “Image Data Converter” and “PlayMemories Home” are checked and follow the instructions on the screen.
 - When the restarting confirmation message appears, restart the computer following the instructions on the screen.
 - DirectX may be installed depending on the system environment of your computer.
-

4 Remove the CD-ROM after the installation is complete.

The following software is installed and shortcut icons appear on the desktop.

“Image Data Converter”

“PlayMemories Home”

“PlayMemories Home Help Guide”

■ Mac

The following computer environment is recommended when using the supplied software and importing images via a USB connection.

OS (pre-installed)	USB Connection: Mac OS X v10.3 to v10.8 “Image Data Converter”: Mac OS X v10.5 to v10.8
“Image Data Converter Ver.4”	CPU: Intel processor, such as Intel Core Solo/Core Duo/Core 2 Duo Memory: 1 GB or more is recommended. Display: 1024 × 768 dots or more

-
- 1 Turn on your Mac computer, and insert the CD-ROM (supplied) into the CD-ROM drive.
-
- 2 Double-click the CD-ROM icon.
-
- 3 Copy the [IDC_INST.pkg] file in the [MAC] folder to the hard disk icon.
-
- 4 Double-click the [IDC_INST.pkg] file in the destination folder.
 - Follow the instructions on the screen to complete the installation.
-

What you can do with the supplied software

■ “PlayMemories Home”

With “PlayMemories Home,” you can do the following:

- You can import images shot with the camera to your computer and display them on the computer.
- You can trim and resize images.
- You can organize images on the computer on a calendar by shooting date to view them.
- You can retouch (Red Eye Correction, etc.), print, send still images as e-mail attachments and change the shooting date.
- You can print or save still images with the date.
- You can create a Blu-ray Disc, AVCHD disc or DVD disc from AVCHD movies imported to a computer. (An internet connection environment is required when a Blu-ray Disc/DVD disc is created for the first time.)

For details on “PlayMemories Home,” refer to “PlayMemories Home Help Guide”.

Double-click the shortcut of  (PlayMemories Home Help Guide) on the desktop, or click [Start] → [All Programs] → [PlayMemories Home] → [PlayMemories Home Help Guide].

“PlayMemories Home” support page (English only)
<http://www.sony.co.jp/pmh-se/>

Notes

- “PlayMemories Home” is not compatible with Mac computers. When you play back images on Mac computers, use the appropriate application software supplied with the Mac computer.
- Movies recorded with the [60p 28M(PS)/50p 28M(PS)]/[60i 24M(FX)/50i 24M(FX)]/[24p 24M(FX)/25p 24M(FX)] setting in [Record Setting] are converted by “PlayMemories Home” in order to create an AVCHD recording disc. This conversion can take a long time. Also, you cannot create a disc in the original image quality. If you want to keep the original image quality, store your movies on a Blu-ray Disc.

■ “Image Data Converter”

With “Image Data Converter,” you can do the following:

- You can play back and edit images recorded in RAW format with various corrections, such as tone curve and sharpness.
- You can adjust images with white balance, exposure, and [Creative Style], etc.
- You can save the images displayed and edited on a computer.
You can either save the image as RAW format or save it in the general file format.
- You can display and compare the RAW images and JPEG images recorded by this camera.
- You can rank images in 5 grades.
- You can apply color labels, etc.

For details on “Image Data Converter,” refer to Help.

Click [Start] → [All Programs] → [Image Data Converter] → [Help] → [Image Data Converter Ver.4].

“Image Data Converter” support page (English only)

<http://www.sony.co.jp/ids-se/>

Adding functions to the camera

You can add the desired functions to your camera by connecting to the application downloading website  (PlayMemories Camera Apps) via the Internet.

For example, the following functions are available:

- You can control the camera using a Smartphone.
- You can use various effects for shooting images.
- You can upload images to network services directly from the camera.

Some applications may be fee-based.

■ Starting up downloading services

1 Access the application downloading website.

<http://www.sony.net/pmca>

- Use Internet Explorer 8 or 9 for Windows, and Safari 5 for Mac.



2 Follow the instructions on the screen and acquire a service account.

- Follow the instructions on the screen to download the desired application to the camera.
-

Notes

- The application downloading function may not be available in some countries and regions. For details, refer to the application downloading website above.

■ Downloading the application

1 Access the application downloading website.

<http://www.sony.net/pmca>

- Use Internet Explorer 8 or 9 for Windows, and Safari 5 for Mac.
-

2 Select the desired application and download the application to the camera following the instructions on the screen.

- Connect the computer and the camera using the micro USB Cable (supplied), following the instructions on the screen.

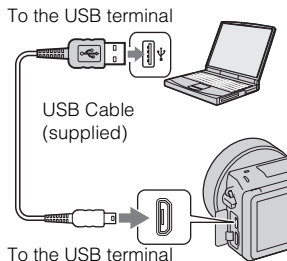

How to download applications directly using Wi-Fi function of the camera

You can download applications using the Wi-Fi function without connecting to a computer.

Select MENU → [Application] →  (PlayMemories Camera Apps), then follow the instructions on the screen to download applications.

Acquire a service account in advance (page 75).

■ Launching the downloaded application

1 Select MENU → [Application] → desired application to launch.

Transferring images to a Smartphone

You can transfer still images to a Smartphone and view them. Download the application “PlayMemories Mobile” to your Smartphone from the application store.

1 Press  (View on Smartphone) and select the desired mode.

- If another function is assigned to soft key B, select MENU → [Playback] → [View on Smartphone].

This Image: Transfers the most recently shot or played back image to the Smartphone.

All Images on This Date:

Transfers all still images in the same date range as the most recently shot or played back image to the Smartphone.

All Images in The Device:

Transfers all still images in the camera to the Smartphone.

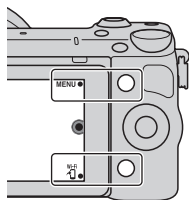

2 If the camera is ready for the transfer, the information screen appears on the camera. Connect the Smartphone and the camera using that information.

- For details on operation of the Smartphone, refer to “α Handbook.”

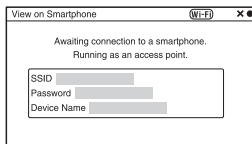

Notes

- Some images may not be displayed on the Smartphone, depending on the recording format.
- The camera shares the connection information for [View on Smartphone] with a device that has permission to connect. If you want to change the device that is permitted to connect to the camera, reset the connection information by following these steps. MENU → [Setup] → [Reset View on Smartphone]. After resetting the connection information, you must register the Smartphone again.
- “PlayMemories Mobile” is not available in some countries/regions. [View on Smartphone] is not available in some countries/regions that are not compatible with “PlayMemories Mobile.”

Connecting to a network

You can transfer images on the camera via Wi-Fi network and view them on other devices. The setting procedure differs depending on your LAN router or wireless LAN access point.

- A computer or TV that is already connected to a network is required at your home, etc.
- Be sure to set the network connection inside your wireless LAN access point area (the accessible area).

Refer to the table below for how to register the access point.

Access point	How to register
Your access point has the WPS button.	Use [WPS Push].
Other than above.	Use [Access Point Settings].

■ WPS Push

- 1 Select MENU → [Setup] → [WPS Push].

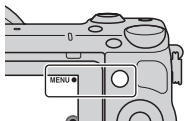

- 2 Press the WPS button on the access point you want to register.

The camera starts communicating with the access point.

■ Access Point Settings

- 1 Select MENU → [Setup] → [Access Point Settings].

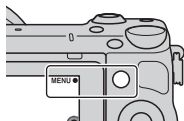

- 2 Select the access point you want to register.

If the desired access point is displayed on the screen:

Select the access point.

If the desired access point is not displayed on the screen:

Select [Manual Setting] and set the access point following the instructions on the screen.

- For details, refer to “α Handbook.”
-

Notes

- When aboard an airplane, turn off the camera.

Saving images to a computer

You can save images on the camera to a computer that is connected to a network. Before saving, install the software “PlayMemories Home” on your computer, connect the computer and the camera using a USB cable, and register the camera to “PlayMemories Home.”

- 1 Select MENU → [Playback] → [Send to Computer].

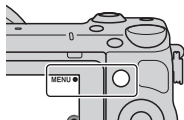

Notes

- Depending on the application settings on your computer, the camera may turn off automatically after the images have been saved.

Viewing images on a TV

You can transfer images on the camera to a network-compatible TV without connecting them using a cable. The transferred images can be played back on the TV.

- 1 Select MENU → [Playback] → [View on TV].

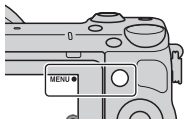

- 2 Select the device to be connected to the camera.

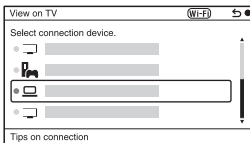

- 3 Press the center of the control wheel to play back images as a slideshow. Or, touch  on the screen.

- Press the right/left side of the control wheel to move to the next/previous image.
- Press or touch OPTION, and then [Device list] to change the device to be connected.

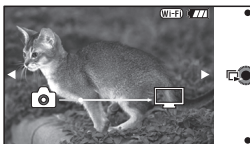

Checking the number of recordable images

Once you insert a memory card into the camera and set the power switch to ON, the number of images that can be recorded (should you continue to shoot using the current settings) is displayed on the LCD screen.



Notes

- When “0” (the number of recordable images) flashes in yellow, the memory card is full. Replace the memory card with another one, or delete images in the current memory card (page 35).
- When “NO CARD” (the number of recordable images) flashes in yellow, it means no memory card has been inserted. Insert a memory card.

Number of still images and time of movies recordable on a memory card

Still images

The following table shows the approximate number of still images that can be recorded on a memory card formatted with this camera. The values are defined using Sony standard memory cards for testing. The values may vary depending on the shooting conditions.

Image size: L 16M

Aspect ratio: 3:2*

(Units: images)

Capacity \ Quality	2GB	4GB	8GB	16GB	32GB	64GB
Standard	410	820	1650	3350	6700	13000
Fine	290	590	1150	2400	4800	9600
RAW & JPEG	79	160	320	640	1300	2600
RAW	105	215	440	880	1750	3550

* When [Aspect Ratio] is set to [16:9], you can record more images than the numbers shown in the table above (except for [RAW]).

Movies

The following table shows the approximate recording times available. These are the total times for all movie files.

(h (hour), m (minute))

Capacity \ Record Setting	Capacity					
	2GB	4GB	8GB	16GB	32GB	64GB
60i 24M(FX) 50i 24M(FX)	10 m	20 m	40 m	1 h 30 m	3 h	6 h
60i 17M(FH) 50i 17M(FH)	10 m	30 m	1 h	2 h	4 h 5 m	8 h 15 m
60p 28M(PS) 50p 28M(PS)	9 m	15 m	35 m	1 h 15 m	2 h 30 m	5 h 5 m
24p 24M(FX) 25p 24M(FX)	10 m	20 m	40 m	1 h 30 m	3 h	6 h
24p 17M(FH) 25p 17M(FH)	10 m	30 m	1 h	2 h	4 h 5 m	8 h 15 m
1440×1080 12M	20 m	40 m	1 h 20 m	2 h 45 m	5 h 30 m	11 h 5 m
VGA 3M	1 h 10 m	2 h 25 m	4 h 55 m	10 h	20 h 5 m	40 h 15 m

Notes

- The recording time of movies varies because the camera uses VBR (Variable Bit Rate), an encoding method that automatically adjusts image quality according to the shooting situation.
When you record a fast-moving subject, the image is clearer but the recording time is shorter because much memory is used.
The recording time also vary depending on the shooting condition or your subject or the setting of image quality/size.
- The duration of time available for movie recording varies with the temperature or condition of the camera before you start recording. If you frequently recompose or shoot still images after the power is turned on, the temperature inside the camera rises and the recording time available will be shorter.
- If the camera stops movie recording due to the temperature, leave the camera for several minutes with the power turned off. Restart recording after the temperature inside the camera goes down.
- If you observe the following points, the recording time is longer.
 - Keep the camera out of direct sunlight.
 - Turn the camera off when it is not being used.

- The maximum size of a movie file is about 2 GB. When the file size is about 2 GB, the movie recording stops automatically when [File Format] is set to [MP4], and a new movie file is created automatically when [File Format] is set to [AVCHD].
- The maximum continuous recording time is approximately 29 minutes.

■ Number of still images recordable with a single charge of the battery pack

The approximate number of images that can be recorded is 330 images when you use the camera with the battery pack (supplied) at full capacity.

Note that the actual numbers may be less depending on the conditions of use.

- The number of images is calculated using full charged battery pack under the following conditions:
 - At an ambient temperature of 25 °C (77 °F).
 - An E PZ 16-50 mm F3.5-5.6 OSS lens is attached.
 - [Quality] is set to [Fine].
 - [Autofocus Mode] is set to [Single-shot AF].
 - Shooting once every 30 seconds.
 - The flash strobes once every two times.
 - The power turns on and off once every ten times.
 - Using the battery pack that is charged for an hour after the charge lamp goes out.
 - Using Sony “Memory Stick PRO Duo” media (sold separately).
- The measurement method is based on the CIPA standard.
(CIPA: Camera & Imaging Products Association)

List of icons on the LCD screen

Icons are displayed on the screen to indicate the camera status.

You can change the screen display using DISP (Display Contents) on the control wheel.

Shooting standby

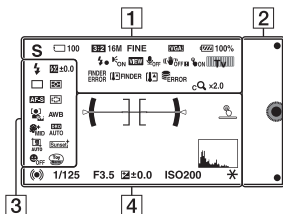

Graphic display

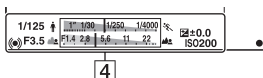

Movie recording

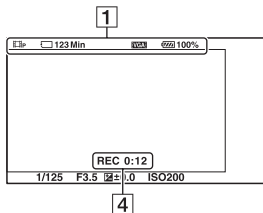

Playback

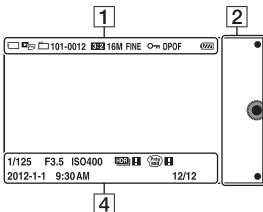

1

Display	Indication
	Shoot Mode
	Scene Selection
	Scene Recognition icon
	Memory card/Upload
100	Number of recordable still images
123Min	Recordable time of movies
3:2 16:9	Aspect ratio of still images
16M 14M 8.4M 7.1M 4M 3.4M	Image size of still images
WIDE STD	

Display	Indication
RAW RAW+J FINE STD	Image quality of still images
60i/50i FX 60i/50i FH 60p/50p PS 24p/25p FX 24p/25p FH 1080 VGA	Recording mode of movies
100%	Remaining battery
	Flash charge in progress
	AF illuminator
VIEW	Live view
OFF	Does not record sound during movie recording
	Wind noise reduction is activated
OFF OFF ON ON	SteadyShot/ SteadyShot warning
ON ON ON	Touch operation status (Touch Shutter/Object Tracking/Touch operation off)
 	Control dial

Display	Indication
FINDER ERROR	Electronic Viewfinder (sold separately) connection error
FINDER FINDER	Electronic Viewfinder (sold separately) overheating warning
	Overheating warning
	Database file full/ Database file error
	Zoom magnification
SQ x2.0	Smart Zoom
CQ x2.0	Clear Image Zoom
DQ x2.0	Digital Zoom
MP4 AVCHD	View mode
101-0012	Playback folder – File number
	Protect
DPOF	Print order
	Wi-Fi wave being emitted

2

Display	Indication
	Soft keys









3

Display	Indication
	Flash Mode/Red Eye Reduction
	Flash compensation
	Drive Mode
	Self-portrait Self-timer
	Metering Mode
	Focus mode
	Focus area mode
	Face Detection
	White Balance
	Soft Skin Effect
	DRO/Auto HDR
	Auto Port. Framing

Display	Indication
	Creative Style
	Smile Shutter
	Picture Effect
	Smile detection sensitivity indicator

4

Display	Indication
	Level
	Phase Detection AF ranging points
	Focus status
	Shutter speed
	Aperture value
	Metered manual

Display	Indication
 ±0.0 -3+2+1+0+1+2+3+	Exposure compensation
ISO400	ISO sensitivity
	AE lock
	Shutter speed indicator
	Aperture indicator
REC 0:12	Recording time of the movie (m:s)
2012-1-1 9:30AM	Recorded date/time of the image
12/12	Image number/ Number of images in the view mode
	Appears when HDR did not work on the image.
	Appears when [Picture Effect] did not work on the image.
	Touch shutter ON/ OFF switch
	Histogram

Learning more about the camera (α Handbook)

“ α Handbook,” which explains how to use the camera in detail, is included on the CD-ROM (supplied). Refer to “ α Handbook” for in-depth instructions on the many functions of the camera.

■ For Windows users

- 1 Turn on your computer, and insert the CD-ROM (supplied) into the CD-ROM drive.
 - 2 Click [Handbook].
 - 3 Click [Install].
 - 4 Start “ α Handbook” from the shortcut on the desktop.
-

■ For Mac users

- 1 Turn on your computer, and insert the CD-ROM (supplied) into the CD-ROM drive.
 - 2 Select the [Handbook] folder and copy “Handbook.pdf” stored in the [GB] folder to your computer.
 - 3 After copying is complete, double-click “Handbook.pdf.”
-

Troubleshooting

If you experience trouble with the camera, try the following solutions.

- 1 Check the items on pages 89 to 93. Also refer to “*α Handbook*” (PDF).**
- 2 Remove the battery pack, wait for about one minute, re-insert the battery pack, and then turn on the power.**
- 3 Reset the settings (page 67).**
- 4 Consult your Sony dealer or local authorized Sony service facility.**

Battery pack and power

The battery pack cannot be installed.

- When you insert the battery pack, use the tip of the battery pack to push the lock lever (page 17).
- You can use an NP-FW50 battery pack only. Make sure that the battery is NP-FW50.

The remaining battery level indicator shows incorrect level or power runs out quickly despite the indicator showing sufficient battery level.

- This phenomenon occurs when you use the camera in an extremely hot or cold location.
- The battery pack is discharged. Install a charged battery pack (page 17).
- The battery pack is dead. Replace the battery pack with a new one.

Cannot turn the camera on.

- Install the battery pack correctly (page 17).
- The battery pack is discharged. Install a charged battery pack (page 17).
- The battery pack is dead. Replace the battery pack with a new one.

The power turns off suddenly.

- When the camera or battery pack is too warm, the camera displays a warning message and turns off automatically to protect the camera.
- If you do not operate the camera for given period of time, the camera turns to power saving mode. To cancel the power save, operate the camera by means such as pressing the shutter button halfway down.

The charge lamp on the camera flashes when charging the battery pack.

- You can only use an NP-FW50 battery pack. Make sure that the battery is NP-FW50.
- If you charge a battery pack that has not been used for a long time, the charge lamp may flash.
- The charge lamp flashes in two ways, fast (about 0.3-second intervals) or slow (about 1.3-second intervals). If the charge lamp is flashing fast, remove the battery pack and reattach the same battery pack securely, or disconnect and reconnect the USB cable. If the charge lamp flashes fast again, it suggests that there is something wrong with the battery pack, AC Adaptor (supplied), or USB cable. Slow flashing indicates that charging is suspended because the ambient temperature is outside the suitable range for charging the battery pack. Charging will resume and the charge lamp will be lit when the ambient temperature returns to within the suitable temperature. The optimal temperature for charging the battery pack is between 10 °C and 30 °C (50 °F and 86 °F).

The battery has not been charged even if the charge lamp has turned off.

- This phenomenon occurs when you use the camera in an extremely hot or cold location. The optimal temperature for charging the battery pack is between 10 °C and 30 °C (50 °F and 86 °F).

The battery pack is not charged.

- When the battery pack is not charged (the charge lamp does not light) even if you follow the proper charging procedure, remove the battery pack and reinsert the same battery pack securely, or disconnect and reconnect the USB cable.

Shooting images

Nothing is displayed on the LCD screen when the power is turned on.

- If you do not operate the camera for given period of time, the camera turns to power saving mode. To cancel the power save, operate the camera, such as pressing the shutter button halfway down.

The shutter does not release.

- You are using a memory card with a write-protect switch, and the switch is set to the LOCK position. Set the switch to the recording position.
- Check the free capacity of the memory card.
- You cannot record images while charging the flash.
- The lens is not attached properly. Attach the lens properly (page 22).

Recording takes a long time.

- The noise reduction function is turned on. This is not a malfunction.
- You are shooting in the RAW mode. Since the RAW data file is large, the RAW mode shooting may take time.
- The [Auto HDR] is processing an image.

The image is out of focus.

- The subject is too close. Check the minimum focal distance of the lens.
- You are shooting in manual focus mode. Set [AF/MF Select] to [Autofocus].
- Ambient light is insufficient.
- The subject may require special focusing. Use the [Flexible Spot] or manual focus function.

The flash does not work.

- Raise the flash (page 26).
- The flash is not attached correctly. Reattach the flash (page 26).
- You cannot use a flash with the following shooting mode:
 - [Bracket: Cont.]
 - [Sweep Panorama]
 - [Night Scene], [Hand-held Twilight] and [Anti Motion Blur] in [Scene Selection]
 - Movie recording

Fuzzy white circular spots appear on images shot using the flash.

- Particles (dust, pollen, etc.) in the air reflected the flash light and appeared on the image. This is not a malfunction.

The flash takes too long to recharge.

- The flash has been fired in succession in a short period. When the flash has been fired in succession, the recharging process may take longer than usual to avoid overheating of the flash.

The image taken with the flash is too dark.

- If the subject is beyond the flash range (the distance that the flash can reach), the pictures will be dark because the flash light does not reach the subject. If the ISO is changed, the flash range also changes with it (page 55).

The date and time are recorded incorrectly.

- Set the correct date and time (page 28).
- The area selected with [Area Setting] is different from the actual area. Set the actual area by selecting MENU → [Setup] → [Area Setting].

The aperture value and/or shutter speed flashes.

- The subject is too bright or too dark, and the camera's available range for the aperture value and/or shutter speed is exceeded. Adjust the setting again.

The image is whitish (Flare).**Blurring of light appears on the image (Ghosting).**

- The picture was taken under backlit conditions, and excessive light has entered the lens. When using the zoom lens, attach a lens hood.

The corners of the picture are too dark.

- If any filter or hood is used, take it off and try shooting again. Depending on the thickness of the filter and improper attachment of the hood, the filter or the hood may partially appear on the image. The optical properties of some lenses may cause the periphery of the image to appear too dark (insufficient light). You may compensate for this phenomenon with [Lens Comp.: Shading].

The eyes of the subject come out red.

- Activate the [Red Eye Reduction] function.
- Get close to the subject, and shoot the subject within the flash range (page 55) using the flash.

Dots appear and remain on the LCD screen.

- This is not a malfunction. These dots are not recorded (page 94).

The image is blurred.

- The picture was taken in a dark location without the flash, resulting in camera-shake. The use of a tripod or the flash is recommended (page 54). [Hand-held Twilight] and [Anti Motion Blur] in [Scene Selection] (page 48) are also effective in reducing blur.

The exposure value is flashing on the LCD screen or the viewfinder.

- The subject is too bright or too dark for the metering range of the camera.

The self-timer lamp does not flash.

- When the LCD screen is tilted upward about 180 degrees with [Self-portrait Self-timer] set to [On] and the camera is ready to take a self-portrait, the self-timer lamp does not flash.

Viewing images

Images cannot be played back.

- The folder/file name has been changed on your computer.
- When an image file has been processed by a computer or when the image file was recorded using a model other than that of your camera, playback on your camera is not guaranteed.
- The camera is in USB mode. Disconnect the camera from the computer.
- Use “PlayMemories Home” to copy images stored on your computer to your camera to play them back on your camera.

Precautions

On the functions available with the camera

- Your camera is 1080 60i-compatible or 1080 50i-compatible.

To check whether the camera is 1080 60i-compatible or 1080 50i-compatible, check for the following marks on the bottom of the camera.

1080 60i-compatible camera: 60i

1080 50i-compatible camera: 50i

- Your camera is compatible with 1080 60p/50p movies. Unlike existing standard recording modes, which record in an interlacing method, this camera records using a progressive method. This increases the resolution, and provides a smoother, more realistic image.

On the LCD screen and lens

- The LCD screen is manufactured using extremely high-precision technology so over 99.99 % of the pixels are operational for effective use. However, there may be some tiny black points and/or bright points (white, red, blue or green in color) that constantly appear on the LCD screen. These points are normal in the manufacturing process and do not affect the images in any way.

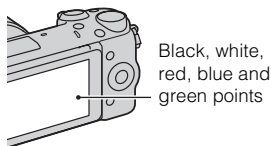

- Do not hold the camera by the LCD screen.
- A magnet is attached to the back of the LCD screen. Do not put objects that are affected by magnetic fields, such as a floppy disk or a credit card, between the LCD screen and the camera body.

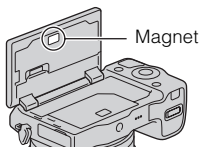

- Images may trail across on the LCD screen in a cold location. This is not a malfunction. When turning on the camera in a cold location, the LCD screen may become temporarily dark.
- Do not press against the LCD screen. The monitor may be discolored and that may cause a malfunction.
- Do not expose the camera to direct sunlight. If reflected sunlight is focused on a nearby object, it may cause a fire. When you must place the camera under direct sunlight, attach the front lens cap.

On using the lenses and accessories

It is recommended that you use Sony lenses/accessories designed to suit the characteristics of this camera.

Using the products of other manufacturers may cause the camera not to operate to its capability, or result in accidents and malfunctions of the camera.

On the Smart Accessory Terminal 2

Set the power switch of the camera to OFF before you attach or remove an accessory, such as the flash, to the Smart Accessory Terminal 2. When attaching an accessory, plug the accessory into the Smart Accessory Terminal 2 to the end and fasten the screw. Make sure that the accessory is attached to the camera securely.

Do not use/store the camera in the following places

- In an extremely hot, dry or humid place
In places such as in a car parked in the sun, the camera body may become deformed and this may cause a malfunction.
- Storing under direct sunlight or near a heater
The camera body may become discolored or deformed, and this may cause a malfunction.
- In a location subject to rocking vibration
- Near strong magnetic place

- In sandy or dusty places
Be careful not to let sand or dust get into the camera. This may cause the camera to malfunction, and in some cases this malfunction cannot be repaired.

On the grip

The grip is applied with a special coating. The grip may be discolored if it is rubbed with dark colored cloth, leather, etc.

On storing

Be sure to attach the front lens cap when not using the camera.

On the temperature of the camera

Your camera and battery may get hot due to continuous use, but it is not a malfunction.

On operating temperatures

Your camera is designed for use under the temperatures between 0 °C and 40 °C (32 °F and 104 °F).

Shooting in extremely cold or hot places that exceed this range is not recommended.

On moisture condensation

If the camera is brought directly from a cold to a warm location, moisture may condense inside or outside the camera. This moisture condensation may cause a malfunction of the camera.

How to prevent moisture condensation

When bringing the camera from a cold place to a warm place, seal the camera in a plastic bag and allow it to adapt to conditions at the new location over about an hour.

If moisture condensation occurs

Turn off the camera and wait about an hour for the moisture to evaporate. Note that if you attempt to shoot with moisture remaining inside the lens, you will be unable to record clear images.

On the internal rechargeable battery

This camera has an internal rechargeable battery for maintaining the date and time and other settings regardless of whether the power is on or off, or the battery is installed or not. This rechargeable battery is continually charged as long as you are using the camera. However, if you use the camera for only short periods, it gradually discharges. If you do not use the camera at all for about three months it becomes completely discharged. In this case, be sure to charge this rechargeable battery before using the camera. However, even if this rechargeable battery is not charged, you can still use the camera as long as you do not record the date and time. If the camera resets to the default settings each time you charge the battery, the internal rechargeable battery may be dead. Consult your Sony dealer or local authorized Sony service

Charging method of the internal rechargeable battery

Insert a charged battery pack into the camera, or connect the camera to a wall outlet (wall socket) using the AC Adaptor (supplied), and leave the camera for 24 hours or more with the power off.

On memory cards

Do not attach a label, etc. on a memory card or a card adaptor. This may cause a malfunction.

On recording/playback

- When you use a memory card with this camera for the first time, it is recommended to format the card using the camera for stable performance of the memory card before shooting. Note that formatting permanently erases all data on the memory card, and is unrecoverable. Save precious data on a computer, etc.
- If you repeatedly record/delete images, fragmentation of data may occur on the memory card. Movies may not be able to be saved or recorded. In such a case, save your images to a computer or other storage location, and then format the memory card.
- The recorded contents cannot be compensated for even if recording or playback is not possible due to a malfunction of the camera or memory card, etc.
- To avoid the potential risk of data loss, always copy (back up) data to other media.

- Before you record one-time events, make a trial recording to make sure that the camera is working correctly.
- This camera is neither dust-proof, nor splash-proof, nor water-proof.
- Do not aim the camera at the sun or other bright light. It may cause the malfunction of the camera.
- Do not look at the sun or a strong light through a removed lens. This may cause irrecoverable damage to your eyes. Or it may cause a malfunction of the lens.
- Do not use the camera near a place that generates strong radio waves or emits radiation. The camera may not be able to record or play back properly.
- Using the camera in sandy or dusty place may cause malfunctions.
- If moisture condensation occurs, remove it before using the camera (page 95).
- Do not shake or strike the camera. In addition to malfunctions and an inability to record images, this may render the memory card unusable, or cause image data breakdown, damage or loss.
- Clean the flash surface with a soft cloth. The heat of flash emission may cause dirt to adhere on the flash surface, resulting in smoking or scorching.
- Keep the camera, supplied accessories, etc., out of the reach of children. A memory card, etc., may be swallowed. If such problem occurs, consult a doctor immediately.

Importing AVCHD movies to a computer

When importing AVCHD movies to a computer, for Windows, use the software “PlayMemories Home” in the CD-ROM (supplied).

On RAW images

To view RAW images recorded with the camera, “Image Data Converter” on the CD-ROM (supplied) is required. If you do not intend to modify the images you record, we recommend that you shoot images using the JPEG format.

Notes on playing movies on other devices

- This camera uses MPEG-4 AVC/H.264 High Profile for AVCHD format recording. Movies recorded in AVCHD format with this camera cannot be played by the following devices.
 - Other devices compatible with AVCHD format that does not support High Profile
 - Devices incompatible with the AVCHD format
- This camera also uses MPEG-4 AVC/H.264 Main Profile for MP4 format recording. For this reason, movies recorded in MP4 format with this camera cannot be played on devices other than those that support MPEG-4 AVC/H.264.

- Discs recorded with HD (high definition) image quality can be played back only on AVCHD format-compatible devices. DVD-based players or recorders cannot play back HD image quality discs, as they are incompatible with the AVCHD format. Also, DVD-based players or recorders may fail to eject HD image quality discs.
- Movies recorded in 1080 60p/1080 50p format can be played back only on 1080 60p/1080 50p-supported devices.

Caution when flying

When aboard an airplane, turn off the camera.

Warning on copyright

Television programs, films, videotapes, and other materials may be copyrighted. Unauthorized recording of such materials may be contrary to the provisions of the copyright laws.

The pictures used in this manual

The photographs used as examples of pictures in this manual are reproduced images, and are not actual images shot using this camera.

On the data specifications described in this manual

The data on performance and specifications are defined under the following conditions, except as described in this manual: at an ordinary ambient temperature of 25 °C (77 °F), and using a battery pack that has been fully charged for about an hour after the charge lamp has turned off.

Specifications

Camera

[System]

Camera type: Interchangeable lens digital camera

Lens: E-mount lens

[Image sensor]

Image sensor: APS-C format (23.5 mm × 15.6 mm) CMOS image sensor

Total pixel number of image sensor:

Approx. 16 700 000 pixels

Effective pixel number of camera:

Approx. 16 100 000 pixels

[Anti-dust]

System: Charge protection coating on

Low-Pass Filter and ultrasonic vibration mechanism

[Auto focus system]

System: Fast Hybrid AF (Phase detection system/Contrast detection system)

Sensitivity range: EV0 to EV20 (at ISO 100 equivalent, with F2.8 lens)

[Exposure control]

Metering method: 1 200-segment metering by the image sensor

Metering range: EV0 to EV20 (at ISO 100 equivalent, with F2.8 lens)

ISO sensitivity (Recommended exposure index):

Still images: AUTO, ISO 100 – 25 600

Movies: AUTO, ISO 100 – 6 400 equivalent

Exposure compensation: ±3.0 EV (1/3 EV step)

[Shutter]

Type: Electronically-controlled, vertical-traverse, focal-plane type

Speed range:

Still images: 1/4 000 second to 30 seconds, BULB

Movies: 1/4 000 second to 1/4 second (1/3 EV step),

1080 60i-compatible device up to 1/60 second in AUTO mode (up to 1/30 second in [Auto Slow Shutter] mode)

1080 50i-compatible device up to 1/50 second in AUTO mode (up to 1/25 second in [Auto Slow Shutter] mode)

Flash sync speed: 1/160 second

[Recording media]

“Memory Stick PRO Duo” media, SD card

[LCD screen]

LCD panel: Wide, 7.5 cm (3.0 type) TFT drive

Total number of dots: 921 600 dots

[Input/output terminals]

USB: Micro USB type B

HDMI: HDMI type C minijack

[Power]

Used battery pack: Rechargeable battery pack NP-FW50

[Power consumption]

When using an E PZ 16–50 mm F3.5–5.6 OSS lens*

Approx. 2.7 W

* supplied with NEX-5RL/5RY

[Others]

Exif Print: Compatible

PRINT Image Matching III:

Compatible

DPOF: Compatible

Dimensions (CIPA compliant):

Approx. 110.8 mm × 58.8 mm ×
38.9 mm (4 3/8 inches ×
2 3/8 inches × 1 9/16 inches)
(W/H/D)

Mass (CIPA compliant):

Approx. 276 g (9.7 oz)
(including battery and "Memory
Stick PRO Duo" media)
Approx. 218 g (7.7 oz)
(camera only)

Operating temperature: 0 °C to 40 °C
(32 °F to 104 °F)

File format:

Still image: JPEG (DCF Ver. 2.0,
Exif Ver. 2.3, MPF Baseline)
compliant, RAW (Sony ARW 2.3
Format)

Movie (AVCHD format): AVCHD
format Ver. 2.0 compatible

Video: MPEG-4 AVC/H.264

Audio: Dolby Digital 2ch

Dolby Digital Stereo Creator

- Manufactured under license from
Dolby Laboratories.

Movie (MP4 format):

Video: MPEG-4 AVC/H.264

Audio: MPEG-4 AAC-LC 2ch

USB communication: Hi-Speed USB
(USB 2.0)

[Wireless LAN]

Supported format: IEEE 802.11 b/g/n

Flash HVL-F7S

Flash guide number: GN 7 (in meters at
ISO 100)

Recycling time: Approx. 4 seconds

Flash coverage: Covering 16 mm lens
(focal length that the lens indicates)

Flash compensation: ±2.0 EV (1/3 EV
step)

Dimensions (CIPA compliant):

Approx. 35.9 mm × 23.8 mm ×
42.7 mm
(1 7/16 inches × 15/16 inches ×
1 11/16 inches)
(W/H/D)

Mass: Approx. 20.4 g (0.8 oz)

AC Adaptor AC-UB10/ UB10B/UB10C/UB10D

Power requirements: AC 100 V to
240 V, 50 Hz/60 Hz, 70 mA

Output voltage: DC 5 V, 0.5 A

Operating temperature: 0 °C to 40 °C
(32 °F to 104 °F)

Storage temperature: -20 °C to +60 °C
(-4 °F to +140 °F)

Dimensions:

Approx. 50 mm × 22 mm × 54 mm
(2 inches × 7/8 inches ×
2 1/4 inches) (W/H/D)

Mass:

For the USA and Canada: Approx.
48 g (1.7 oz)

For countries or regions other than
the USA and Canada: Approx. 43 g
(1.5 oz)

Rechargeable battery pack NP-FW50

Used battery: Lithium-ion battery

Maximum voltage: DC 8.4 V

Nominal voltage: DC 7.2 V

Maximum charge voltage: DC 8.4 V

Maximum charge current: 1.02 A

Capacity: Typical 7.7 Wh (1 080 mAh)
Minimum 7.3 Wh (1 020 mAh)

Maximum dimensions:

Approx. 31.8 mm × 18.5 mm ×
45 mm (1 5/16 inches × 3/4 inches
× 1 13/16 inches) (W/H/D)

Mass: Approx. 57 g (2.1 oz)

Lens

Lens	E16 – 50 mm zoom lens ¹⁾	E18 – 55 mm zoom lens	E55 – 210 mm zoom lens
Camera	NEX-5RL/5RY	NEX-5RK	NEX-5RY
Equivalent 35 mm-format focal length ²⁾ (mm)	24 – 75	27 – 82.5	82.5 – 315
Lens groups – elements	8 – 9	9 – 11	9 – 13
Angle of view ²⁾	83° – 32°	76° – 29°	28.2° – 7.8°
Minimum focus ³⁾ (m (feet))	0.25 – 0.3 (0.82 – 1)	0.25 (0.82)	1.0 (3.28)
Maximum magnification (×)	0.215	0.3	0.225
Minimum f-stop	f/22 – f/36	f/22 – f/32	f/22 – f/32
Filter diameter (mm)	40.5	49	49
Dimensions (max. diameter × height) (Approx. mm (in.))	64.7 × 29.9 (2 5/8 × 1 3/16)	62.0 × 60.0 (2 1/2 × 2 3/8)	63.8 × 108 (2 5/8 × 4 3/8)
Mass (Approx. g (oz.))	116 (4.1)	194 (6.8)	345 (12.2)
SteadyShot	Available	Available	Available

1) Power zoom

2) The values for equivalent 35 mm-format focal length and angle of view are based on digital cameras equipped with an APS-C sized image sensor.

3) Minimum focus is the shortest distance from the image sensor to the subject.

Design and specifications are subject to change without notice.

On focal length

The picture angle of this camera is narrower than that of a 35 mm-format camera. You can find the approximate equivalent of the focal length of a 35 mm-format camera, and shoot with the same picture angle, by increasing the focal length of your lens by half. For example, by using a 50 mm lens, you can get the approximate equivalent of a 75 mm lens of a 35 mm-format camera.

On image data compatibility

- This camera conforms with DCF (Design rule for Camera File system) universal standard established by JEITA (Japan Electronics and Information Technology Industries Association).
- Playback of images recorded with your camera on other equipment and playback of images recorded or edited with other equipment on your camera are not guaranteed.

Trademarks

- **α** is a trademark of Sony Corporation.
- “Memory Stick,” , “Memory Stick PRO,” **MEMORY STICK PRO**, “Memory Stick Duo,” **MEMORY STICK DUO**, “Memory Stick PRO Duo,” **MEMORY STICK PRO DUO**, “Memory Stick PRO-HG Duo,” **MEMORY STICK PRO-HG DUO**, “Memory Stick Micro,” “MagicGate,” and **MAGICGATE** are trademarks of Sony Corporation.
- “InfoLITHIUM” is a trademark of Sony Corporation.
- “PlayMemories Camera Apps” is a trademark of Sony Corporation.

- “PhotoTV HD” is a trademark of Sony Corporation.
- Blu-ray Disc™ and Blu-ray™ are trademarks of the Blu-ray Disc Association.
- “AVCHD Progressive” and “AVCHD Progressive” logotype are trademarks of Panasonic Corporation and Sony Corporation.
- Dolby and the double-D symbol are trademarks of Dolby Laboratories.
- Microsoft, Windows, and Windows Vista are either registered trademarks or trademarks of Microsoft Corporation in the United States and/or other countries.
- HDMI, the HDMI logo and High-Definition Multimedia Interface are trademarks or registered trademarks of HDMI Licensing LLC.
- Mac and Mac OS are trademarks or registered trademarks of Apple Inc.
- iOS is a trademark or registered trademark of Cisco Systems Inc.
- Intel, Intel Core, and Pentium are trademarks or registered trademarks of Intel Corporation.
- Android is a registered trademark of Google Inc.
- DLNA and DLNA CERTIFIED are trademarks of Digital Living Network Alliance.
- SDXC logo is a trademark of SD-3C, LLC.
- Eye-Fi is a trademark of Eye-Fi Inc.
- MultiMediaCard is a trademark of MultiMediaCard Association.
- “” and “PlayStation” are registered trademarks of Sony Computer Entertainment Inc.
- Adobe is a registered trademark or a trademark of Adobe Systems Incorporated in the United States and/or other countries.

- In addition, system and product names used in this manual are, in general, trademarks or registered trademarks of their respective developers or manufacturers. However, the TM or ® marks are not used in all cases in this manual.



- Add further enjoyment with your PlayStation 3 by downloading the application for PlayStation 3 from PlayStation Store (where available).
- The application for PlayStation 3 requires PlayStation Network account and application download. Accessible in areas where the PlayStation Store is available.



Index

A

Access Point Settings.....	79
AEL w/ shutter.....	64
AF Illuminator	64
AF Micro Adj.	66
AF/MF Select.....	60
Anti Motion Blur	48
Aperture Priority.....	51
Application	63
Area Setting	66
Aspect Ratio.....	61
Auto Port. Framing	60
Auto Review	64
Auto Slow Shutter.....	66
Autofocus Area.....	60
Autofocus Mode	60

B

Background Defocus Control	42
Battery pack	17
Beep.....	66

C

Calibration	67
Charging time	17
Cleaning Mode.....	67
Clear Image Zoom	64
Color Space.....	65
Computer	71
Cont. Shooting	45
Control dial	37
Control wheel.....	36
Creative Style.....	62
CTRL FOR HDMI.....	67
Custom Key Settings	66

D

Date/Time Setup.....	29, 66
Delete	35, 63
Demo Mode.....	67
Digital Zoom	65
DISP (Display Contents).....	46
DISP Button(Monitor)	61
Disp MAC Address	68
Display Card Space	68
Display Color	67
Display Contents	63
Downloading application	75
Drive Mode	60
DRO/Auto HDR.....	62

E

Edit Device Name	68
Enlarge Image	63
Exposure compensation	44
Eye-Fi.....	68
Eye-Start AF.....	65

F

Face Detection.....	60
Face Priority Tracking.....	66
Face Registration.....	60
File Format	56, 62
File Number	68
Fill-flash	54
Finder Display(DISP).....	61
FINDER/LCD Setting	64
Flash Comp.	62
Flash Mode.....	54
Fn (Function) button	55
Folder Name.....	68
Format	68
Front Curtain Shutter.....	65
Function Menu Settings	66

G			
Grid Line.....	64	MF Assist	65
H		MF Assist Time.....	65
Handbook.....	88	Moisture condensation	95
Hand-held Twilight.....	48	Movie	32
HDMI Resolution	67	Movie Audio Rec	66
Help Guide Display	67	MOVIE Button.....	66
Help Guides	40	N	
High ISO NR	65	New Folder.....	68
I		Night Portrait.....	48
Icons.....	84	Night Scene	48
Image Data Converter.....	74	O	
Image Index	57, 63	Object Tracking.....	60
Image Size	56, 61	P	
Initialize	67	Panorama.....	49
Install	71	Panorama Direction.....	61
Intelligent Auto	47	Peaking Color.....	64
ISO.....	62	Peaking Level.....	64
L		Phase Detection AF Area	64
Landscape	48	Photo Creativity	41
Language.....	66	Picture Effect.....	43, 62
LCD Brightness	67	Playback	33
LCD Display (DISP).....	61	Playback Display.....	67
Lens.....	22	PlayMemories Home.....	73
Lens Comp.: Chro. Aber.....	66	Portrait.....	48
Lens Comp.: Distortion	66	Power Save.....	67
Lens Comp.: Shading.....	65	Power Saving Start Time	67
Level	46	Program Auto	52
Live View Display	64	Protect	63
Long Exposure NR	65	Q	
M		Quality.....	61
Mac	72		
Macro.....	48		
Manual Exposure	47		
Memory card.....	24		
Menu	59		
Menu start	66		
Metering Mode	62		

R

Record Setting	62
Recover Image DB	68
Red Eye Reduction	64
Release w/o Lens	65
Reset Default	67
Reset Network Settings.....	68
Reset View on Smartphone	68
Rotate	63

S

S. Auto Image Extract.....	65
Scene Selection.....	48
Scroll playback	50
Select Shoot. Folder.....	68
Self-portrait Self-timer.....	65
Self-timer	44
Self-timer(Cont).....	45
Send to Computer	79
Setting the clock	29
Setup	64
Shoot Mode.....	47
Shooting (movies).....	32
Shooting (still images).....	30
Shooting Tip List	61
Shooting tips	40
Shutter Priority.....	50
Slide Show	63
Smile Shutter	60
Soft keys	37
Soft Skin Effect.....	61
Software	71
Spd Priority Cont.	46
Specifications.....	99
Specify Printing	63
Sports Action	48
SteadyShot	65
Still/Movie Select	63
Sunset.....	48
Superior Auto.....	52
Sweep Panorama.....	49

T

Touch Operation.....	38, 66
Touch panel.....	38
Touch Shutter	31, 60

U

Upload Settings	68
USB Connection.....	67

V

Version	67
View mode	63
View on Smartphone.....	77
View on TV (HDMI cable compatible TV).....	58
View on TV (Network compatible TV).....	80
Viewfinder Bright.	67
Volume Settings	63

W

White Balance	62
Wide Image	67
Wi-Fi	78
Wind Noise Reduct.	66
Windows	71
WPS Push.....	78

Z

Zoom	53, 60
------------	--------