

Contents

Getting started.....	3
Phone overview.....	4
Turning on the phone.....	5
Help.....	6
Charging the battery.....	6
Maximising battery performance.....	6
Screen icons.....	8
Menu overview.....	9
Navigation.....	10
Media memory.....	11
Phone language.....	11
Entering text.....	11
Calling.....	13
Making and answering calls.....	13
Contacts	14
Speed dial.....	16
More calling features.....	17
Messaging.....	21
Text and picture messages.....	21
Conversations.....	22
Voice messages.....	22
Email.....	22
Pictures and videos.....	25
Viewing pictures and videos.....	25
Using pictures and videos.....	25
Music	26
Stereo portable handsfree.....	26
Music player.....	26
Playlists.....	27
Audio books.....	27
Buy Now.....	28
TrackID™ technology	28
Online music and video clips.....	28
Radio	28
Recording sound	29
Transferring and handling content.....	30
Handling content in the phone.....	30
Sending content to another phone.....	30
Using a USB cable.....	30

Transferring content to and from a computer.....	31
Phone name.....	32
Using Bluetooth™ wireless technology.....	32
Backing up and restoring.....	33
Updating your phone.....	35
Updating your phone using a computer.....	35
Updating your phone wirelessly.....	35
Internet	36
To access the web browser toolbar.....	36
Web browser shortcuts.....	36
Bookmarks.....	36
History pages.....	37
Smart-Fit Rendering™.....	37
More browser features.....	37
Internet security and certificates.....	37
File transfers.....	37
Synchronising.....	39
Synchronising using a computer.....	39
Synchronising using an Internet service.....	39
More features.....	40
Flight mode.....	40
Alarms.....	40
Calendar.....	41
Notes.....	41
Tasks.....	42
Profiles.....	42
Time and date.....	42
Themes.....	43
Main menu layout.....	43
Ringtones.....	43
Games.....	43
Applications.....	44
Antivirus.....	44
PIN codes.....	45
IMEI number.....	45
Troubleshooting.....	47
Common questions.....	47
Error messages.....	49
Legal information.....	50
Index.....	51

Getting started

Important information

Please read the *Important information* leaflet before you use your mobile phone.

Phone overview

- 1 Ear speaker
- 2 Screen
- 3 Selection keys
- 4 Volume key
- 5 Call key
- 6 Activity menu key
- 7 Connector for charger, handsfree and USB cable
- 8 End key
- 9 C key (Clear)
- 10 Navigation key
- 11 Phone antenna

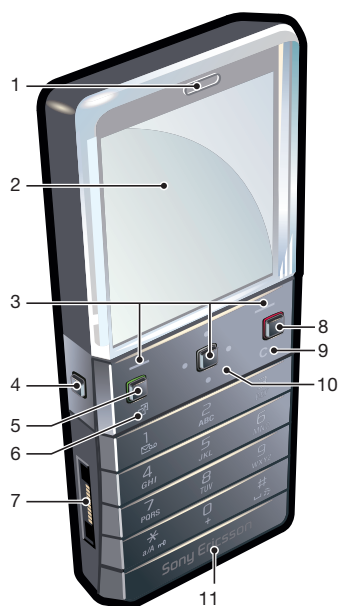

- 12 On/off, reset key
- 13 Volume key
- 14 SIM card slot

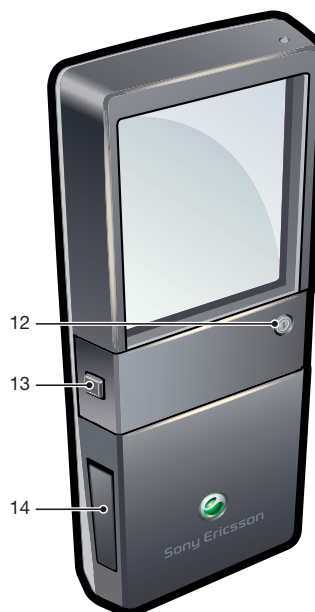

To insert the SIM card

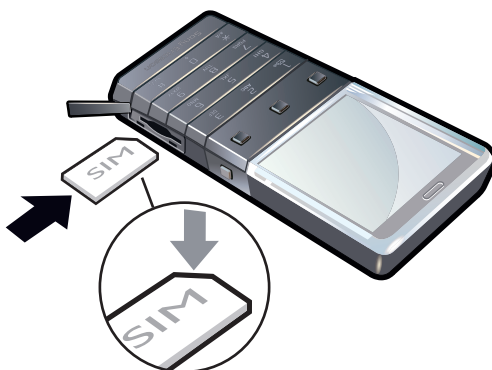

- Open the cover and insert the SIM card with the gold-coloured contacts facing down.

To remove the SIM card

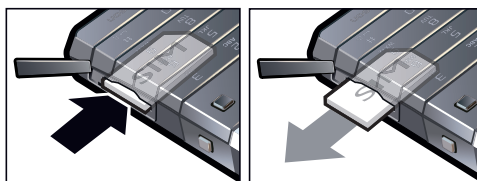

- Open the cover and press the edge of the SIM card to release and remove it.

Turning on the phone

To turn on the phone



- 1 On the back of the phone, press and hold down **I**.
- 2 Enter your SIM card PIN (Personal Identification Number), if requested, and select **OK**.
- 3 Select a language.
- 4 Follow the instructions that appear.

💡 If you want to correct a mistake when you enter your PIN, press **C**.

SIM card

The SIM (Subscriber Identity Module) card, which you get from your network operator, contains information about your subscription. Always turn off your phone and detach the charger before you insert or remove the SIM card.

💡 You can save contacts on the SIM card before you remove it from your phone.

PIN

You may need a PIN (Personal Identification Number) to activate the services and functions in your phone. Your PIN is supplied by your network operator. Each PIN digit appears as *, unless it starts with emergency number digits, for example, 112 or 911. You can see and call an emergency number without entering a PIN.

! If you enter the wrong PIN three times in a row, the SIM card is blocked. See *SIM protection* on page 45.

Standby

After you have turned on your phone and entered your PIN, the name of the network operator appears. This view is called standby. Your phone is now ready for use.

Using other networks

Making and receiving calls, using messaging and data transfer, for example, Internet-based services, outside your home network (roaming) may incur additional costs. Contact your operator for more information.

Help

In addition to this User guide, Feature guides and more information are available at www.sonyericsson.com/support.

There are also help functions and a User guide in your phone. See the following instructions on how to access them.

To access the User guide in your phone

- Select **Menu** > **Settings** > **User help** > **User guide**.

To view tips and tricks

- Select **Menu** > **Settings** > **User help** > **Tips and tricks**.

To view information about functions

- Scroll to a function and select **Info**, if available. In some cases, **Info** appears under **Options**.

To view the phone status

- Press a volume key. Phone, memory and battery information is shown.

Supported services and features

- ! Some of the services and features described in this User guide are not supported by all networks and/or service providers in all areas. Without limitation, this applies to the GSM International Emergency Number 112. Please contact your network operator or service provider to determine availability of any specific service or feature and whether additional access or usage fees apply.

Charging the battery

The phone battery is partly charged when you buy it.

- ! The phone battery cannot be removed.

To charge the battery

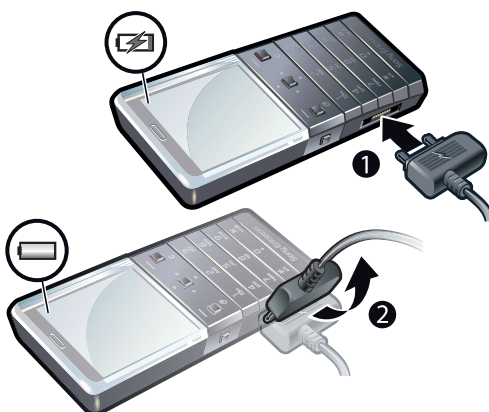

- 1 Connect the charger to the phone.
- 2 Remove the charger by tilting the plug upwards.





























Maximising battery performance

- Charge your phone often. The battery lasts longer if you charge it frequently.
- If you are in an area with no coverage, your phone repeatedly scans for available networks. This consumes power. If you cannot move to an area with better coverage, turn off your phone temporarily.
- Turn off 3G and Bluetooth™ wireless technology when you do not need these functions.

- Do not cover the phone antenna when you are engaged in a call.
- 💡 Go to www.sonyericsson.com/support to learn more about how to maximise the battery performance.

Screen icons

These icons may appear on the screen:

Icon	Description
	The battery is almost fully charged
	The battery needs charging
	The network coverage is good
	No network coverage (also shown in flight mode)
	A 3G network is available
	A UMTS HSPA network is available
	Missed calls
	Calls diverted
	Ongoing call
	The microphone is muted
	The loudspeaker is on
	The phone is in silent mode
	New text message
	New multimedia message
	New email
	The music player is playing
	The radio is playing
	A handsfree is connected
	The Bluetooth function is activated
	A Bluetooth headset is connected
	The phone is connected to the Internet
	Secure website
	An alarm is activated
	Appointment reminder
	Task reminder
	A Java application is activated
	Activating Antivirus
	USB cable is connected

Menu overview*

Radio

Alarms

Calls**



All



Answered



Dialled



Missed

Organiser

Calendar

Tasks

Notes

Synchronisation

Timer

Stopwatch

Calculator

Applications

File manager **

File transfer

Messaging

Write new

Inbox/Conversations

Messages

Email

Call voicemail

Contacts

Myself

New contact

Entertainment

Online services

Internet

TrackID™

Games

Record sound

Music player

Settings

General

Profiles

Time & date

Language

Update software

Voice control

Shortcuts

Flight mode

Auto. keylock

PIN codes

Security

Accessibility

Phone status

Master reset

Sounds & alerts

Ring volume

Ringtone

Silent mode

Increasing ring

Vibrating alert

Message alert

Key sound

Display

Wallpaper

Layout

Theme

Startup screen

Screen saver

Brightness

Edit line names

Calls

Speed dial

Smart search

Divert calls

Switch to line 2

Manage calls

Time

Show/hide my no.

Handsfree

Connectivity

Bluetooth

USB

Phone name

Synchronisation

Device managem.

Mobile networks

Data comm.

Internet settings

Streaming sett.

Message settings

SIP settings

Accessories

User help

User guide

Settings downl.

Basic setup

Tips and tricks

* Some menus are operator-, network- and subscription-dependent.

** You can use the navigation key to scroll between tabs in submenus.

Navigation

To access the main menu

- When **Menu** appears on the screen, press the centre selection key to select **Menu**.
- If **Menu** does not appear on the screen, press End key, and then press the centre selection key to select **Menu**.

To navigate the phone menus



- Press the navigation key upwards, downwards, left or right to move through the menus.

To select actions on the screen

- Press the left, centre or right selection key.

To view options for an item

- Select **Options** to, for example, edit.

To end a function

- Press the End key.

To return to standby

- Press the End key.

To delete items

- Press **(C)** to delete items such as numbers, letters, pictures and sounds.

Keypad lock

You can set the keypad lock to avoid accidental dialling. **RLD** appears. Incoming calls can be answered without unlocking the keypad.

- ! Calls to the international emergency number 112 can still be made.

To lock the keypad manually

- 1 Press **(+*)#**.
- 2 Select **Lock**.

To unlock the keypad

- 1 Press **(+*)#**.
- 2 Select **Unlock**.

To use the automatic keylock

- 1 Select **Menu > Settings > General > Auto. keylock**.
- 2 Select an option.

Tabs

Tabs may be available. For example, **Calls** have tabs.



To scroll between tabs

- Press the navigation key left or right.

Shortcuts

You can use the navigation key shortcuts to go directly to functions from standby.

To use navigation key shortcuts

- Press the navigation key upwards, downwards, left or right, to go directly to a function.

To edit a navigation key shortcut

- 1 Select **Menu > Settings > General > Shortcuts.**
- 2 Scroll to an option and select **Edit.**
- 3 Scroll to a menu option and select **Shortc..**

Main menu shortcuts

Menu numbering starts from the top left icon and moves across and then down row by row.

To go directly to a main menu item

- Select **Menu** and press (1) – (9).
- ! The **Layout** must be set to **Grid**. See *To change the main menu layout* on page 43.

Activity menu

The activity menu gives you quick access to:

- **New events** – missed calls and new messages.
- **Running apps** – applications that are running in the background.
- **My shortcuts** – add your favourite functions to access them quickly.

To open the activity menu

- Press (⌘).

Media memory

You can save content in the Media memory, in the phone memory and on the SIM card. Pictures, videos and music are saved in the Media memory. If the Media memory is full, pictures videos and music are saved in the phone memory. Messages and contacts are saved in the phone memory, but you can choose to save them on the SIM card.

Phone language

You can select a language to use in your phone.

To change the phone language

- 1 Select **Menu > Settings > General > Language > Phone language.**
- 2 Select an option.

Entering text

You can use multitap text input or Quick text input  to enter text. The Quick text input method uses a dictionary application in your phone.

To change the writing language

- When you enter text, press and hold down .







To change the text input method

- When you enter text, press and hold down .



To shift between upper- and lower-case letters or numbers

- When you enter text, press .









To enter numbers

- 1 When you enter text, press  repeatedly until  appears at the top of the screen.
 - 2 To enter a number, press  .
-  To enter a number from text input mode, you can press and hold down  – .





To enter punctuation marks and symbols

- 1 When you enter text, press  briefly.
 - 2 Scroll to a symbol and select **Insert**.
-  To select from the most commonly used punctuation marks, you can also press .

To enter text using Quick text input

- 1 Select, for example, **Menu > Messaging > Write new > Message**.
- 2 If  is not displayed, press and hold down  to change to Quick text input.
- 3 Press each key only once, even if the letter you want is not the first letter on the key. For example, to write the word “Jane”, press    . Write the whole word before looking at the suggestions.
- 4 To view word suggestions, press  or press the navigation key downwards.
- 5 Press  to accept a suggestion and add a space.

To enter text using the multitap method

- 1 Select, for example, **Menu > Messaging > Write new > Message**.
- 2 If  is displayed, press and hold down  to change to multitap text input.
- 3 Press  –  repeatedly until the desired letter appears.
- 4 Press  to add a space.

To add words to the phone dictionary

- 1 When you enter text using Quick text input, select **Options > Spell word**.
- 2 Write the word using multitap input and select **Save**.

Calling

You need to turn on your phone and be within range of a network.

Making and answering calls

To make a call

- 1 Enter a phone number (with international country code and area code, if applicable).
- 2 Press the Call key.

 You can call numbers from Contacts and your call list.

To end a call

- Press the End key.

To make international calls

- 1 Press and hold down  until a “+” sign appears.
- 2 Enter the country code, area code (without the first zero) and phone number.
- 3 Press the Call key.

To re-dial a number

- When **Retry?** appears, select **Yes**.

 Do not hold your phone to your ear when waiting for the call to connect. When the call connects, your phone gives a loud signal.

To answer a call

- Press the Call key.



To reject a call

- Press the End key.

To change the ear speaker volume during a call

- Press the volume keys up or down.

To mute the microphone during a call

- 1 Press and hold down .  appears.
- 2 Press and hold down  again to resume.

To turn on the loudspeaker during a call

- Select **Spkr on**.  appears.

 Do not hold the phone to your ear when using the loudspeaker. This could damage your hearing.

To view missed calls from standby

-  appears. Press the Call key to open the call list.

Emergency calls

Your phone supports international emergency numbers, for example, 112 or 911. You can normally use these numbers to make emergency calls in any country, with or without the SIM card inserted, if you are within range of a network.

 In some countries, other emergency numbers may also be promoted. Your network operator may therefore have saved additional local emergency numbers on the SIM card.

To make an emergency call

- Enter 112 (the international emergency number) and press the Call key.

To view your local emergency numbers

- 1 Select **Menu > Contacts**.
- 2 Scroll to **New contact** and select **Options > Special numbers > Emerg. numbers**.

Networks

Your phone switches automatically between GSM and **3G** (UMTS) or **H** networks depending on availability. Some network operators allow you to switch networks manually.

To switch networks manually

- 1 Select **Menu > Settings > Connectivity > Mobile networks > GSM/3G networks**.
- 2 Select an option.

Call list

You can view information about answered , dialled  and missed or rejected  calls.

To call a number from the call list

- 1 Press the Call key and scroll to a tab.
- 2 Scroll to a name or a number and press the Call key.

Contacts

You can save names, phone numbers and personal information in **Contacts**. Information can be saved in the phone memory or on the SIM card.

-  You can synchronise your contacts using the Sony Ericsson PC Suite.

Default contacts

You can choose which contact information is shown by default. If **Phone contacts** is selected as the default, only contact information saved to the phone memory is listed in **Contacts**. If you select **SIM contacts** as the default, only names and numbers saved on the SIM card are shown in **Contacts**.

To select default contacts

- 1 Select **Menu > Contacts**.
- 2 Scroll to **New contact** and select **Options > Advanced > Default contacts**.
- 3 Select an option.

Phone contacts

Phone contacts can contain names, phone numbers and personal information. They are saved in the phone memory.

To add a phone contact

- 1 Select **Menu > Contacts**.
- 2 Scroll to **New contact** and select **Add**.
- 3 Enter the name and select **OK**.
- 4 Scroll to **New number:** and select **Add**.
- 5 Enter the number and select **OK**.
- 6 Select a number option.
- 7 Scroll between the tabs and add information to the fields.
- 8 Select **Save**.

Calling contacts

To call a contact

- 1 Select **Menu > Contacts**.
- 2 Scroll to a contact and press the Call key.

To go directly to the contacts list

- Press and hold down **(2)** – **(9)**.

To call with Smart search

- 1 Press **(0-9)** – **(9)** to enter a sequence of (at least two) digits. All entries which match the sequence of digits or corresponding letters are shown in a list.
- 2 Scroll to a contact or a phone number and press the Call key.

To turn on or off Smart search

- 1 Select **Menu > Settings > Calls > Smart search**.
- 2 Select an option.

Editing contacts

To add information to a phone contact

- 1 Select **Menu > Contacts**.
- 2 Scroll to a contact and select **Options > Edit contact**.
- 3 Scroll between the tabs and select **Add** or **Edit**.
- 4 Select an option and an item to add or edit.
- 5 Select **Save**.

- 💡 If your subscription supports Calling Line Identification (CLI) services, you can assign personal ringtones and pictures to contacts.

To copy names and numbers to phone contacts

- 1 Select **Menu > Contacts**.
- 2 Scroll to **New contact** and select **Options > Advanced > Copy from SIM**.
- 3 Select an option.

To copy names and numbers to the SIM card

- 1 Select **Menu > Contacts**.
- 2 Scroll to **New contact** and select **Options > Advanced > Copy to SIM**.
- 3 Select an option.

- ⚠ When you copy all contacts from your phone to the SIM card, all existing SIM card information is replaced.

To automatically save names and phone numbers on the SIM card

- 1 Select **Menu > Contacts**.
- 2 Scroll to **New contact** and select **Options > Advanced > Auto save on SIM**.
- 3 Select an option.

To save contacts in the Media memory

- 1 Select **Menu > Contacts**.
- 2 Scroll to **New contact** and select **Options > Advanced > Save to memory**.

SIM contacts

SIM contacts can contain names and numbers only. They are saved on the SIM card.

To add a SIM contact

- 1 Select **Menu > Contacts**.
- 2 Scroll to **New contact** and select **Add**.
- 3 Enter the name and select **OK**.
- 4 Enter the number and select **OK**.
- 5 Select a number option and add more information, if available.
- 6 Select **Save**.

Deleting contacts

To delete all contacts

- 1 Select **Menu > Contacts**.
- 2 Scroll to **New contact** and select **Options > Advanced > Del. all contacts**.
- 3 Select an option.

Contact memory status

The number of contacts you can save in your phone or on the SIM card depends on available memory.

To view contact memory status

- 1 Select **Menu > Contacts**.
- 2 Scroll to **New contact** and select **Options > Advanced > Memory status**.

Myself

You can enter information about yourself and, for example, send your business card.

To enter information in Myself

- 1 Select **Menu > Contacts**.
- 2 Scroll to **Myself** and select **Open**.
- 3 Scroll to an option and edit the information.
- 4 Select **Save**.

To add your own business card

- 1 Select **Menu > Contacts**.
- 2 Scroll to **Myself** and select **Open**.
- 3 Scroll to **My contact info** and select **Add > Create new**.
- 4 Scroll between the tabs and add information to the fields.
- 5 Enter the information and select **Save**.

Groups

You can create a group of phone numbers and email addresses from **Phone contacts** to send messages to. You can also use groups (with phone numbers) when you create accepted callers lists.

To create a group of numbers and email addresses

- 1 Select **Menu > Contacts**.
- 2 Scroll to **New contact** and select **Options > Groups**.
- 3 Scroll to **New group** and select **Add**.
- 4 Enter a name for the group and select **Continue**.
- 5 Scroll to **New** and select **Add**.
- 6 For each contact phone number or email address you want to mark, scroll to it and select **Mark**.
- 7 Select **Continue > Done**.

To edit a group of numbers and email addresses

- 1 Select **Menu > Contacts**.
- 2 Scroll to **New contact** and select **Options > Groups**.
- 3 Scroll to an existing group and select **Edit**.
- 4 To add a new contact, scroll to **New** and select **Add**. To delete a contact from the group, scroll to the contact and select **Delete**.
- 5 When you are finished, select **Done**.

Speed dial

Speed dialling lets you select nine contacts that you can dial quickly from standby. The contacts can be saved in positions 1-9.

To assign speed dial numbers to contacts

- 1 Select **Menu > Contacts**.
- 2 Scroll to **New contact** and select **Options > Speed dial**.
- 3 Scroll to a position number and select **Add**.
- 4 Select a contact.

To speed dial

- Enter the position number and press the Call key.

More calling features

Voicemail

If your subscription includes an answering service, callers can leave a voicemail message when you cannot answer a call.

To enter your voicemail number

- 1 Select **Menu > Messaging > Messages > Settings > the Message settings tab > Voicemail no.**
- 2 Enter the number and select **OK**.

To call your voicemail service

- Press and hold down **(1)**.

Voice control

By creating voice commands you can:

- Voice dial – call someone by saying their name
- Answer and reject calls when you use a handsfree

To record a voice command using voice dialling

- 1 Select **Menu > Settings > General > Voice control > Voice dialling > Activate**.
 - 2 Select **Yes > New voice comm.** and select a contact. If the contact has more than one number, select the number to add the voice command to.
 - 3 Follow the instructions that appear. Wait for the tone and say the command to record. Record a voice command such as “John mobile”. The voice command is played back to you.
 - 4 If the recording sounds OK, select **Yes**. If not, select **No** and repeat steps 3 and 4.
- ! Voice commands are saved in the phone memory only. They cannot be used in another phone.

To voice dial a contact

- 1 Press and hold down a volume key.
- 2 Wait for the tone and say a recorded voice command, for example “John mobile.” The phone plays the command back to you and connects the call.

To activate voice answering and record voice answer commands

- 1 Select **Menu > Settings > General > Voice control > Voice answer > Activate**.
- 2 Follow the instructions that appear and select **Continue**. Wait for the tone and say “Answer”, or say any other word.
- 3 Select **Yes** to accept or **No** to make a new recording.
- 4 Wait for the tone and say “Busy”, or say any other word.
- 5 Select **Yes** to accept or **No** to make a new recording.
- 6 Follow the instructions that appear and select **Continue**.
- 7 Select the environments in which you want to activate voice answering.

To answer a call using voice commands

- Say “Answer.”

To re-record a voice command

- 1 Select **Menu > Settings > General > Voice control > Voice dialling > Edit names.**
- 2 Scroll to a command and select **Options > Replace voice.**
- 3 Wait for the tone and say the command.

Diverting calls

You can divert calls, for example, to an answering service.

- ! When **Restrict calls** is used, some divert call options are not available.

To divert calls

- 1 Select **Menu > Settings > Calls > Divert calls.**
- 2 Select a call type and a divert option.
- 3 Select **Activate.**  appears.
- 4 Enter the number to divert calls to and select **OK.**

Call waiting

You will hear a beep if you receive a second call while call waiting is active.

To activate call waiting

- Select **Menu > Settings > Calls > Manage calls > Call waiting > Activate.**

More than one call

You can handle more than one call at a time. For example, you can put an ongoing call on hold while you make or answer a second call. You can also switch between the two calls. You cannot answer a third call without ending one of the first two calls.

To switch between two calls

- During the call, press the Call key.

To join two calls

- During the call, select **Options > Join calls.**

To end an ongoing call and return to the call on hold

- Press the End call key, then the Call key.

To make a second call

- 1 During the call, press the Call key. This puts the ongoing call on hold.
- 2 Select **Options > Add call.**
- 3 Enter the number to call and press the Call key.

To answer a second call

- During the call, press the Call key. This puts the ongoing call on hold.

To reject a second call

- During the call, press **End call** and continue with the ongoing call.

To end an ongoing call and answer a second call

- During the call, select **Replace active call.**

Conference calls

With a conference call, you can have a joint conversation with up to five people.

To add a new participant

- 1 During the call, press the Call key. This puts the joined calls on hold.
- 2 Select **Options** > **Add call**.
- 3 Enter the number to call and press the Call key.
- 4 Select **Options** > **Join calls** to add the new participant.
- 5 Repeat this task to add more participants.

To release a participant

- 1 Select **Options** > **Release party**.
- 2 Select the participant to release.

To have a private conversation

- 1 During the call, select **Options** > **Talk to** and select the participant to talk to.
- 2 To resume the conference call, select **Options** > **Join calls**.

My numbers

You can view, add and edit your own phone numbers.

To check your phone numbers

- 1 Select **Menu** > **Contacts**.
- 2 Scroll to **New contact** and select **Options** > **Special numbers** > **My numbers**.
- 3 Select an option.

Accept calls

You can choose to receive calls from certain phone numbers only.

To add numbers to the accepted callers list

- 1 Select **Menu** > **Settings** > **Calls** > **Manage calls** > **Accept calls** > **Only from list**.
- 2 Scroll to **New** and select **Add**.
- 3 Select a contact or **Groups**.

To accept all calls

- Select **Menu** > **Settings** > **Calls** > **Manage calls** > **Accept calls** > **All callers**.

Restricted dialling

You can restrict outgoing and incoming calls. A password from your service provider is required.

- ! If you divert incoming calls, you cannot use some restrict calls options.

Restrict calls options

Standard options are:

- **All outgoing** – restrict all outgoing calls
- **Outgoing intl** – restrict all outgoing international calls
- **Outg. intl roam.** – restrict all outgoing international calls except to your home country
- **All incoming** – restrict all incoming calls
- **Inc. when roaming** – restrict all incoming calls when you are abroad

To restrict calls

- 1 Select **Menu** > **Settings** > **Calls** > **Manage calls** > **Restrict calls**.
- 2 Select an option.
- 3 Select **Activate**.
- 4 Enter your password and select **OK**.

Call time and cost

During a call, the phone shows how long you have been talking. You can also check on the duration of your last call, your outgoing calls and the total time of all your calls.

To check the call time

- Select **Menu > Settings > Calls > Time > Call timers.**

Showing or hiding your phone number

You can decide to show or hide the number displayed on the call recipient's phone when you make a call.

To hide your phone number

- 1 Select **Menu > Settings > Calls > Show/hide my no..**
- 2 Select **Hide number.**

Messaging

Text and picture messages

Messages can contain text, pictures, sound effects, animations, and melodies.

When sending messages, the phone automatically selects the most suitable method (as a text or picture message) for sending the message.

If you cannot use picture messages, see *I cannot use Internet-based services* on page 48.



Sending messages

You can send messages from your phone. The maximum size of a standard text message is 160 characters (including spaces) if no other items are added to the message. If you enter more than 160 characters, a second message is created. Your messages are sent as one concatenated message.

To create and send a message

- 1 Select **Menu** > **Messaging** > **Write new** > **Message**.
 - 2 Enter text. To add items to the message, press the navigation key downwards, scroll by pressing the navigation key left or right, and select an item.
 - 3 Select **Continue** > **Contacts look-up**.
 - 4 Select a recipient and select **Send**.
- ! If you send a message to a group, you may be charged for each member. Contact your service provider for details.

Receiving and saving messages

You are notified when you receive a message.  or  appears. Messages are automatically saved in the phone memory. When the phone memory is full, you can delete messages or save them on the SIM card or in the Media memory.

To view a message in the inbox

- 1 Select **Menu** > **Messaging** > **Messages** > **Inbox**.
- 2 Scroll to the message and select **View**.

To save all incoming messages in the Media memory

- Select **Menu** > **Messaging** > **Messages** > **Settings** > **Save to** > **Media memory**.

To save a message on the SIM card

- 1 Select **Menu** > **Messaging** > **Messages** and select a folder.
- 2 Scroll to a message and select **Options** > **Save message**.

To call a number contained in a message

- When you are viewing the message, scroll to the phone number and press the Call key.

Message options

You can set some options, such as the Message alert and default storage location, to apply to all messages. You can set other options, such as the Delivery priority and Delivery time, for each message you send.

To set options for all messages

- 1 Select **Menu** > **Messaging** > **Messages** > **Settings**.
- 2 Select an option.

To set options for a specific message

- 1 When the message is ready and a recipient is selected, select **Options** > **Advanced**.
- 2 Scroll to an option and select **Edit**.

Conversations

You can choose whether to view your messages in **Conversations** or the **Inbox**. A messaging conversation shows all messaging communication between you and one of your contacts.

To view messages in Conversations

- Select **Menu** > **Messaging** > **Inbox** > the **Conversations** tab.
- Select **Menu** > **Messaging** > **Conversations** and select a conversation.

To send a message from Conversations

- 1 Select **Menu** > **Messaging**.
- 2 Select **Conversations**, or select **Inbox** > the **Conversations** tab.
- 3 Select a conversation.
- 4 Write a message and select **Send**.

Voice messages

You can send and receive a sound recording as a voice message.

- ! The sender and recipient must have a subscription supporting multimedia messaging.

To record and send a voice message

- 1 Select **Menu** > **Messaging** > **Write new** > **Voice msg**.
- 2 Record the message and select **Stop** > **Send** > **Contacts look-up**.
- 3 Select a recipient and select **Send**.

Email

You can get e-mail in your phone and use all standard e-mail functions.

- 💡 You can synchronise your email using the Microsoft® Exchange ActiveSync® application.

Before using email

You can use the setup wizard to check if settings for your email account can be automatically downloaded. If this does not work, you will be prompted to enter settings manually.

- ! To use email, you need the correct Internet settings in your phone. If you cannot use the Internet, see *I cannot use Internet-based services* on page 48.

To create an email account for the first time

- 1 To start the email setup wizard, select **Menu** > **Messaging** > **Email**.
- 2 Follow the instructions to create the account.

- 💡 If you need to enter settings manually, you can contact your email provider for more information. An email provider could be the company that supplied your email address.

To write and send an email message

- 1 Select **Menu > Messaging > Email**.
- 2 If you have several email accounts, select the account you want to send the message from.
- 3 Select **Write new**.
- 4 To add a recipient, scroll to **To:** and select **Add > Enter email addr..** Enter the email address and select **OK**.
- 5 To add more recipients, scroll to **To:** and select **Edit**. Scroll to an option and select **Add**. When you are ready, select **Done**.
- 6 To enter a subject, scroll to **Subject:**, select **Edit**, enter the subject, and select **OK**.
- 7 To enter the message text, scroll to **Text:**, select **Edit**, enter the text, and select **OK**.
- 8 Select **Add** to attach a file.
- 9 Select **Continue > Send**.

To receive and read an email message

- 1 Select **Menu > Messaging > Email**.
- 2 If you have several email accounts, select an account.
- 3 Select **Inbox > Options > Check email**.
- 4 Scroll to the message and select **View**.

To reply to an email message

- 1 Select **Menu > Messaging > Email**.
- 2 If you have several email accounts, select an account.
- 3 Select **Inbox**.
- 4 Scroll to the message and select **Options > Reply**.
- 5 Write the reply and select **OK**.
- 6 Select **Continue > Send**.

To use an attachment in an email message

- 1 When you view the message, select **Options > Attachments > Use**.
- 2 Select an option.

Active email account

If you have several email accounts, you can change which one is active.

To change the active email account

- 1 Select **Menu > Messaging > Email**.
- 2 If you have several email accounts, select an account.
- 3 Select **Accounts**.
- 4 Select the account you want to activate.

To create additional email accounts

- 1 Select **Menu > Messaging > Email**.
- 2 If you have several email accounts, select an account.
- 3 Select **Accounts**.
- 4 Scroll to **New account** and select **Add**.

Checking for new email messages automatically

You can set your phone to check for new email messages automatically. You can use a time interval for the check, or you can let the phone stay connected to the email server (push email). The phone will only check for email messages for the active email account. When you receive a new email message,  appears on the screen.

To set the interval for checking for new email messages

- 1 Select **Menu > Messaging > Email**.
- 2 If you have several email accounts, select an account.
- 3 Select **Settings > the Download tab > Check interval**.
- 4 Select an option.

To turn on push email

- 1 Select **Menu > Messaging > Email**.
 - 2 If you have several email accounts, select an account.
 - 3 Select **Settings > the Download tab > Push email**.
-  When using push email, the phone stays connected to the email server and normal traffic rates apply. Contact your network operator for details.

Pictures and videos

You can view pictures and videos that you have received or downloaded to your phone. Saved pictures and videos can be found in the **File manager**.

Viewing pictures and videos

To view pictures

- 1 Select **Menu > Organiser > File manager > Pictures**.
- 2 Scroll to a picture and select **View**.
- 3 To scroll through the pictures, press the navigation key left or right.

To play videos

- 1 Select **Menu > Organiser > File manager > Videos**.
- 2 Scroll to a video and select **View**.
- 3 Select **Play**.

To stop playing a video

- Press the centre selection key.

To fast forward and rewind

- Press and hold down the navigation key right or left.

To change the volume

- Press the volume keys up or down.

Using pictures and videos

You can add a picture to a contact, use the picture during phone startup, as a wallpaper in standby, or as a screen saver. You can use a video as a startup screen.

To use pictures

- 1 Select **Menu > Organiser > File manager > Pictures**.
- 2 Scroll to a picture and select **Options > Use as**.

To use videos

- 1 Select **Menu > Organiser > File manager > Videos**.
- 2 Scroll to a video and select **Options > Use as**.

Music

You can listen to music, audio books and podcasts. Use Media Go™ to transfer content to and from your phone. For more information, see *Transferring content to and from a computer* on page 31.

Stereo portable handsfree



To use a handsfree

- Connect a portable handsfree. Music stops when you receive a call and resumes when the call has ended.
- ! If headphones are not included with the phone, you may purchase them separately.

Music player

To play music

- 1 Select **Menu** > **Music player**.
- 2 Select **Options** > **My music**.
- 3 Browse by category using the navigation key.
- 4 Press the centre selection key to play music.

To stop playing music

- Press the centre selection key.

To fast forward and rewind

- Press and hold down the navigation key right or left.

To move between tracks

- Press the navigation key right or left.

To change the volume

- Press the volume keys up or down.

To minimise the music player

- Select **Options** > **Minimise**.

To return to the music player

- Select **Menu** > **Music player**.

Music player options

The following **Options** may be available when you listen to music:

- **My music** – browse your music tracks.
- **Settings**

- **Play mode** – select **Shuffle** to play tracks randomly in a playlist or **Loop** to restart a playlist after the last track ends.
- **Equaliser** – change the settings of the treble and bass when playing a track.
- **Stereo widen.** – change the output sound to enhance the stereo experience.
- **File**
 - **Send** – send a track using an available transfer method.
 - **Delete** – remove tracks. Tracks are only removed from the current playlist.
- **Save playlist** – save a play queue to a new playlist.
- **Minimise** – minimise the music player and return to standby with music still playing.

Playlists

You can create playlists to organise your music. You can add tracks and folders to a playlist. It may take a few minutes for the phone to create a playlist.

To create a playlist

- 1 Select **Menu** > **Music player** > **Options** > **Save playlist**.
- 2 Enter a name and select **OK**.
- 3 Select **Options** > **My music** > **Playlists** and select your playlist to view it.
- 4 To add tracks, scroll to **Add music** and select **Add**.
- 5 For each track you want to add, scroll to the track and select **Mark**.
- 6 Select **Add** to add the marked track to the playlist.

To add tracks to a playlist

- 1 Select **Menu** > **Music player**.
- 2 Select **Options** > **My music** > **Playlists** and select a playlist.
- 3 Scroll to **Add music** and select **Add**.
- 4 For each track you want to add, scroll to the track and select **Mark**.
- 5 Select **Add** to add the marked tracks to the playlist.

To delete tracks from a playlist

- 1 Select **Menu** > **Music player**.
- 2 Select **Options** > **My music** > **Playlists** and select a playlist.
- 3 Scroll to a track and press **(C)**.

To delete playlists

- 1 Select **Menu** > **Music player**.
- 2 Select **Options** > **My music** > **Playlists**.
- 3 Scroll to a playlist and press **(C)**.

Playlist options

The following may be available under **Options**:

- **Add music** – add tracks or folders to the playlist.
- **Resume** – start playing the track you last listened to. If music is playing, **Resume** takes you back to the player view.
- **Information** – view information about a track you have selected.
- **Delete** – delete a playlist or a track from a playlist. Only the reference to the track is removed and not the track itself. The tracks are still listed in **File manager**.
- **Rename** – rename a playlist. You can only rename user-created playlists.
- **Send** – send a track using an available transfer method.

Audio books

If you use Media Go™ to transfer audio books to your phone from a computer, you can listen to the audio books in your phone. It may take a few minutes before a transferred audio book appears in the list of available audio books.

To access audio books

- 1 Select **Menu > Music player**.
- 2 Select **Options > My music > Books**.

💡 You can find audio books in formats other than M4B and in those that do not have ID3v2 chapter tags in the **Tracks** folder.

Buy Now

If you subscribe to a music service allowing limited, non-permanent use with your phone, you can mark a track you are interested in buying later. The next time you synchronise your music with Windows Media® Player on a computer with enabled Internet access, you should be asked if you want to buy the track you marked earlier. If you accept, the track is downloaded to your computer and your selected music service account is charged. This service requires a subscription and account with a downloadable music service, a computer with Microsoft® Windows Media® Player 11 or subsequent compatible version of Windows Media® Player, and a USB computer connection.

! You cannot see that a track is marked. You cannot unmark tracks you have already marked.

To mark a track

- When the track you want to mark is playing, press and hold down (⏸).

TrackID™ technology

TrackID™ technology is a music recognition service. You can search for title, artist and album name for a track you hear playing through a loudspeaker or on the radio in your phone. If you cannot use TrackID™ technology, see *I cannot use Internet-based services* on page 48.

To search for track information

- When you hear a track playing through a loudspeaker, select **Menu > Entertainment > TrackID™ > Start**.
- When the radio in your phone is playing, select **Options > TrackID™**.

💡 For best results, use TrackID™ in a quiet area.



Online music and video clips

You can view video clips and listen to music by streaming them to your phone from the Internet. If you cannot use the Internet, see *I cannot use Internet-based services* on page 48.

To select a data account for streaming

- 1 Select **Menu > Settings > Connectivity > Streaming sett. > Connect using:**.
- 2 Select the data account to use.
- 3 Select **Save**.

To stream music and video clips

- 1 Select **Menu > Entertainment > Internet**.
- 2 Select  and then select .
- 3 Select a link to stream from.

Radio

! To listen to the radio, you need to use wired headphones that act as an antenna for the radio. The Bluetooth headset supplied with the phone cannot function as an antenna. If wired headphones are not included with the phone, you need to purchase them separately.

! Do not use your phone as a radio in places where this is prohibited.

To turn on the radio

- 1 Connect a handsfree to the phone.
- 2 Select **Menu > Radio**.

To search for channels automatically

- Select **Search**.

To fine tune the frequency

- Press the navigation key right or left.

To change the volume

- Press the volume keys up or down.

To minimise the radio

- Select **Options > Minimise**.

To return to the radio

- Select **Menu > Radio**.

Saving channels

You can save up to 20 preset channels.

To save channels automatically

- Select **Options > Channels > Auto save**.

To save channels manually

- 1 When you find a radio channel, select **Options > Channels > Save**.
- 2 Scroll to a position and select **Insert**.
- 3 If you want, you can rename the channel. Select **Save**.

💡 You can also save a channel in a position by pressing and holding down **(0-)** - **(9)**.

To switch between saved channels

- Press the navigation key upwards or downwards.

💡 You can also select a saved channel by pressing **(0-)** - **(9)**.

Recording sound

You can record a voice memo or a call. Recorded sounds can also be set as ringtones.

- ! In some countries or states, it is required by law that you inform the other person before recording a call.

To record a sound

- 1 Select **Menu > Entertainment > Record sound > Record**.
- 2 To stop recording and save, select **Save**.

To record a call

- 1 During an ongoing call, select **Options > Record**.
- 2 To save the recording, select **Save**.

To listen to a recording

- 1 Select **Menu > Organiser > File manager**.
- 2 Scroll to **Music** and select **Open**.
- 3 Scroll to a recording and select **Play**.

Transferring and handling content

You can transfer and handle content such as pictures and music.

- ! You are not allowed to exchange some copyright-protected material.  identifies a protected item.

Handling content in the phone

You can use **File manager** in your phone to handle content saved in the phone memory in the Media memory. Tabs and icons in **File manager** show where the content is saved. If the memory is full, delete some content to create space.

To view memory status

- 1 Select **Menu > Organiser > File manager**.
- 2 Select **Options > Memory status**.
- 3 Select **Media memory** or **Phone**.

To select more than one item in a folder

- 1 Select **Menu > Organiser > File manager**.
- 2 Scroll to a folder and select **Open**.
- 3 Select **Options > Mark > Mark several**.
- 4 For each item you want to mark, scroll to the item and select **Mark**.

To move items between the phone memory and the Media memory

- 1 Select **Menu > Organiser > File manager**.
- 2 Find an item and select **Options > Manage file > Move**.
- 3 Select **Media memory** or **Phone**.
- 4 Scroll to a folder and select **Open**.
- 5 Select **Paste**.

To view information about content

- 1 Select **Menu > Organiser > File manager**.
- 2 Find an item and select **Options > Information**.

Sending content to another phone

You can send content using different transfer methods, for example, Messages or Bluetooth wireless technology.

To send content

- 1 Scroll to an item and select **Options > Send**.
 - 2 Select a transfer method.
- ! Make sure the receiving device supports the transfer method you select.

Using a USB cable

You can connect your phone to a computer using a USB cable. If you are using a computer running Microsoft® Windows®, where you have not already installed the necessary USB software, you are asked to install PC Companion.

- ! You may have to purchase a USB cable separately. Only use a USB cable supported by your phone. Check that Autoplay functionality is enabled on your PC.

To disconnect the USB cable safely

-  Do not disconnect the USB cable when transferring content as this may corrupt the content.

- 1 **Computer:** Right-click the *Safely Remove Hardware* icon in Microsoft® Windows® Explorer.
- 2 Select the drives you want to disconnect. Select *Stop*.
- 3 Wait until you are notified that it is safe to remove the drive. Disconnect the USB cable.

PC Companion

PC Companion lets you:

- Explore content in your phone.
 - Use your phone as a modem.
 - Install PC software used to synchronise, transfer and back up phone content.
- For more information, including Feature guides, go to www.sonyericsson.com/support.
- 💡 To download Mac® compatible software, go to www.sonyericsson.com/support.

To install PC Companion

- ! If the necessary USB software has not been installed on your PC, you need to install PC Companion. Autoplay functionality needs to be enabled on your PC.
- 1 Connect your phone to a computer running Microsoft® Windows® using a USB cable supported by your phone.
 - 2 **Computer:** Follow the on-screen instructions.

Required operating systems

You need one of these operating systems to use Sony Ericsson PC software:

- Microsoft® Windows Vista™
- Microsoft® Windows® XP, Service Pack 2 or higher

Transferring content to and from a computer

You can use Media Go™ to transfer media content between your phone and a computer. Media Go™ is available for download through PC Companion or from www.sonyericsson.com/support.

- 💡 To download Mac® compatible software, go to www.sonyericsson.com/support.

Dragging and dropping content

You can drag and drop content between your phone memory, the Media memory and a computer using Microsoft® Windows® Explorer.

To drag and drop content

- 1 Connect your phone to a computer using a USB cable.
- 2 **Computer:** Wait until the phone memory and Media memory appear as external disks in Microsoft® Windows® Explorer.
- 3 Drag and drop selected files between the phone and the computer.

To transfer content using Media Go™

- 1 Connect the phone to a computer with a USB cable supported by your phone.
- 2 **Computer:** Select *Start/Programs/Sony/Media Go™*.
- 3 Select *Transfer to or from Device using Media Go™* and click *OK*.
- 4 Wait until the phone appears in Media Go™.
- 5 Move files between your phone and the computer in Media Go™.

To transfer content using the Media Transfer Protocol (MTP)

- ! If you are connecting to a computer, check that the computer has MTP support.

- 1 Select **Menu > Settings > Connectivity > USB > Set default mode.**
- 2 In the **Set default mode** window, select **PC mode, Other OS** or **MTP devices**, depending on the operating system or kind of device that you are connecting to.
- 3 Connect your phone to the computer or device using a USB cable supported by your phone.
 - If you are connecting to a computer, wait until the phone memory and Media memory appear as external disks in, for example, Microsoft® Windows® Explorer, or Finder if you are using a Mac computer. You can then drag and drop selected files between the phone and computer in the usual manner.
 - If you are connecting to an MTP device, see the User guide for the MTP device for more information on how to connect and transfer files.

To transfer content using mass storage mode

- 1 Select **Menu > Settings > Connectivity > USB > Set default mode.**
- 2 In the **Set default mode** window, select **USB memory** to transfer music, pictures and other files.
- 3 Connect your phone to the computer using a USB cable supported by your phone.
- 4 **Computer:** Wait until the phone memory and Media memory appear as external disks in, for example, Microsoft® Windows® Explorer, or Finder if you are using a Mac computer.
- 5 Drag and drop selected files between the phone and computer in the usual manner.

Phone name

You can enter a name for your phone that is shown to other devices when using, for example, Bluetooth™ wireless technology.

To enter a phone name

- 1 Select **Menu > Settings > Connectivity > Phone name.**
- 2 Enter the phone name and select **OK.**

Using Bluetooth™ wireless technology

Use Bluetooth™ technology to wirelessly connect to other devices, free of charge. You can, for example:

- Connect to handsfree devices.
 - Connect to several devices at the same time.
 - Connect to computers and access the Internet.
 - Exchange MP3 files, virtual business cards, photos, and more.
 - Play multiplayer games.
- ! A range of less than 10 metres (33 feet), with no solid objects in between, is recommended for Bluetooth communication.

Before using Bluetooth wireless technology

You must turn on the Bluetooth function to communicate with other devices. You may also have to pair your phone with other Bluetooth devices.

To turn on the Bluetooth function

- Select **Menu > Settings > Connectivity > Bluetooth > Turn on.**
- ! Make sure that the device you want to pair your phone with has the Bluetooth function activated and Bluetooth visibility turned on.

To pair the phone with another device

- 1 Select **Menu > Settings > Connectivity > Bluetooth > Add new device.**
- 2 Select a device.
- 3 Enter a passcode, if required.

To allow connections to the phone

- 1 Select **Menu > Settings > Connectivity > Bluetooth**.
- 2 Select a device from the list.
- 3 Select **Options > Allow conn..**
- 4 Select **Always ask** or **Always allow**.

! This is only possible with devices that require access to a secure service.

Power saving

You can save battery power with the Power save function. In Power save mode you can only connect to a single Bluetooth device. If you want to connect to more than one Bluetooth device at the same time, you must turn off this function.

To turn on Power save

- Select **Menu > Settings > Connectivity > Bluetooth > Options > Power save > On**.

To turn off Power save

- Select **Menu > Settings > Connectivity > Bluetooth > Options > Power save > Off**.

Transferring sound to and from a Bluetooth handsfree

You can transfer sound to and from a Bluetooth handsfree using the phone keypad or the appropriate key on the handsfree.

To transfer sound

- 1 Select **Menu > Settings > Connectivity > Bluetooth > Options > Incoming call**.
- 2 Select an option. **In phone** transfers sound to the phone. **In handsfree** transfers sound to the handsfree.

! If you select the option **In phone** and answer using the handsfree key, the sound transfers to the handsfree.

To transfer sound during a call

- 1 During a call, select **Sound**.
- 2 Select from the list of available handsfree devices.

Backing up and restoring

You can back up and restore contacts, the calendar, tasks, notes and bookmarks using the Sony Ericsson PC Suite.

Before backing up and restoring, you need to install the Sony Ericsson PC Suite, which is available through PC Companion or from www.sonyericsson.com/support.

You can back up and restore contacts in your phone using the Media memory. You can move content between the Media memory and the phone memory. See *Handling content in the phone* on page 30.

💡 Back up your phone content regularly to make sure you do not lose it.

To make a backup using the Sony Ericsson PC Suite

- 1 **Computer:** Start the Sony Ericsson PC Suite from *Start/Programs/Sony Ericsson/Sony Ericsson PC Suite*.
- 2 Follow the instructions in the Sony Ericsson PC Suite on how to connect.
- 3 Go to the backup and restore section in the Sony Ericsson PC Suite and make a backup of your phone content.

To restore phone content using the Sony Ericsson PC Suite

! The Sony Ericsson PC Suite overwrites all phone content during the restore process. You may damage your phone if you interrupt the process.

- 1 **Computer:** Start the Sony Ericsson PC Suite from *Start/Programs/Sony Ericsson/Sony Ericsson PC Suite*.
- 2 Follow the instructions in the Sony Ericsson PC Suite on how to connect.
- 3 Go to the backup and restore section in the Sony Ericsson PC Suite and restore your phone content.

Updating your phone

You can update your phone with the most recent software for optimal performance and to get the latest enhancements. This is done with the Update Service application. You have two options to update your phone with the Update Service application:

- Using a computer
 - Wireless update
- ! Remember to back up your phone content before updating with a computer. See *Backing up and restoring* on page 33.

Updating your phone using a computer

You can update your phone with the latest software by connecting it to a computer on which the Update Service application is installed. You need a USB cable and an Internet-connected PC.

To learn how, go to

www.sonyericsson.com/update.

Updating your phone wirelessly

You can update your phone over the air using the Update Service application in the phone. You do not lose personal or phone information.

- ! Update Service requires data access such as GPRS, 3G or HSDPA.

To select settings for Update Service

- Select **Menu > Settings > General > Update software > Settings > Internet settings**.

To use Update Service

- 1 Select **Menu > Settings > General > Update software**.
- 2 Select **Search for update** and follow the instructions that appear.

Internet

If you cannot use the Internet, see *I cannot use Internet-based services* on page 48.

To start the web browser

- Select **Menu > Entertainment > Internet**.

To go back when browsing





- To go back to the previous page, select .

To exit the browser

- 1 When you are browsing the web, select  and then select .
- 2 Select **Exit browser**.





To access the web browser toolbar

When you are viewing a web page, select . The following options appear:

Icon	Function
	Pan and zoom the web page
	Search the web or enter a web address
	Manage your favourite web pages
	Manage the files you have downloaded from the Internet

Web browser shortcuts



You can use the keypad to go directly to a web browser function.

Key	Shortcut
	Bookmarks
 - 	Enter text to enter an address, search the Internet or search in Bookmarks
	Zoom
	Overview (when Smart-Fit is off)



Bookmarks

You can create and edit bookmarks as quick links to your favourite web pages.



To create a bookmark

- 1 When you are viewing a web page you want to add to your bookmarks, select  and then select .
- 2 Select **Add as bookm..**

To select a bookmark

- 1 Select **Menu > Entertainment > Internet**.
- 2 When you are browsing the Internet, select  and then select .
- 3 Scroll to a bookmark and select **Go to**.



To send a bookmark

- 1 Select **Menu > Entertainment > Internet**.
- 2 When you are browsing the Internet, select  and then select .
- 3 Scroll to a bookmark, then select **Options**.
- 4 Select **Send** and select a transfer method.

History pages

You can view and go to web pages you have previously visited.

To view history pages

- 1 Select **Menu** > **Entertainment** > **Internet**.
- 2 Select  and then select .
- 3 Select **History**.

Smart-Fit Rendering™



With Smart-Fit Rendering™ on, the web page is adjusted to your display to avoid horizontal scrolling. With Smart-Fit Rendering™ off, you can pan and zoom while viewing a web page.

To turn on or off Smart-Fit Rendering™

- 1 Select **Menu** > **Entertainment** > **Internet**.
- 2 Select  and then select .
- 3 Select **Settings** > **Smart-Fit**.
- 4 Select an option.



More browser features

To use pan and zoom on a web page



- 1 When you are viewing a web page, select , then select .
- 2 Use the navigation key to move the frame.
- 3 Press the centre selection key to zoom in on a part of the web page.

! To use pan and zoom, **Smart-Fit** must be turned off.



To save a picture from a web page

- 1 When you are viewing a web page, select  and then select .
- 2 Select **Save picture**.
- 3 Select a picture.

To find text on a web page

- 1 When you are viewing a web page, select  and then select .
- 2 Select **Find on page**.
- 3 Enter text and press **Find**.

To send a link

- 1 When you are viewing a web page, select  and then select .
- 2 Select **Send link** and select a transfer method.

! Make sure the receiving device supports the transfer method you select.

Internet security and certificates

Your phone supports secure browsing. Certain Internet services, such as banking, require certificates in your phone. Your phone may already contain certificates when you buy it or you can download new certificates.

To view certificates in the phone

- Select **Menu** > **Settings** > **General** > **Security** > **Certificates**.

File transfers

The File transfer manager keeps track of the files you download from the Internet, for example media files and games, and helps you access them. In the File transfer manager

you can also install downloaded Java applications, and pause, resume or cancel downloads.

To access a file using File transfer

- 1 Select **Menu > Organiser > File transfer**.
- 2 Scroll to the file.
- 3 Press the centre selection key to access the file, or select **Options** for other actions.

Synchronising

You can synchronise your phone in two different ways: using a computer program, or using an Internet service.

- 💡 Use only one of the synchronisation methods at a time with your phone.

For more information, go to www.sonyericsson.com/support to read the *Synchronisation* Feature guide.

Synchronising using a computer

You can use a USB cable or Bluetooth wireless technology to synchronise phone contacts, appointments, bookmarks, tasks and notes using an online service or a computer program such as Microsoft® Outlook®.

Before synchronising, you need to install the Sony Ericsson PC Suite. Sony Ericsson PC Suite software is available for download through PC Companion or from www.sonyericsson.com/support.

- 💡 Mac® compatible software is also available for download at www.sonyericsson.com/support.

To synchronise using the Sony Ericsson PC Suite

- 1 **Computer:** Start Sony Ericsson PC Suite from *Start/Programs/Sony Ericsson/Sony Ericsson PC Suite*.
- 2 Follow the instructions in the Sony Ericsson PC Suite for how to connect.
- 3 When you are notified that the Sony Ericsson PC Suite has found your phone, you can start synchronising.

- 💡 For usage details, see the Sony Ericsson PC Suite Help section once the software has been installed on your computer.

Synchronising using an Internet service

You can synchronise with an Internet service using SyncML™ or a Microsoft® Exchange Server using Microsoft Exchange ActiveSync. For more information, go to www.sonyericsson.com/support to read the *Synchronisation* Feature guide.

More features

Flight mode

In **Flight mode** the network and radio transceivers are turned off to prevent disturbance to sensitive equipment.

When the flight mode menu is activated you are asked to select a mode the next time you turn on your phone:

- **Normal mode** – full functionality
- **Flight mode** – limited functionality

To activate the flight mode menu

- Select **Menu > Settings > General > Flight mode > Continue > Show at startup**.

To select flight mode

- 1 When the flight mode menu is activated, turn off your phone.
- 2 Turn on your phone and select **Flight mode**.  appears.

Alarms

You can set a sound or the radio as an alarm signal. The alarm sounds even if the phone is turned off. When the alarm sounds, you can silence it or turn it off.

To set the alarm

- 1 Select **Menu > Alarms**.
- 2 Scroll to an alarm and select **Edit**.
- 3 Scroll to **Time:** and select **Edit**.
- 4 Enter a time and select **OK > Save**.

To set the recurrent alarm

- 1 Select **Menu > Alarms**.
- 2 Scroll to an alarm and select **Edit**.
- 3 Scroll to **Recurrent:** and select **Edit**.
- 4 Scroll to a day and select **Mark**.
- 5 To select another day, scroll to the day and select **Mark**.
- 6 Select **Done > Save**.

To set the alarm signal

- 1 Select **Menu > Alarms**.
- 2 Scroll to an alarm and select **Edit**.
- 3 Scroll to the  tab.
- 4 Scroll to **Alarm signal:** and select **Edit**.
- 5 Find and select an alarm signal. Select **Save**.

To silence the alarm

- When the alarm sounds, press any key.
- To repeat the alarm, select **Snooze**.

To turn off the alarm

- When the alarm sounds, press any key, then select **Turn off**.

To cancel the alarm

- 1 Select **Menu > Alarms**.
- 2 Scroll to an alarm and select **Turn off**.

To set the snooze duration

- 1 Select **Menu > Alarms**.
- 2 Scroll to an alarm and select **Edit**.
- 3 Scroll to **Snooze duration:** and select **Edit**.
- 4 Select an option.

The alarm in silent mode

You can set the alarm not to sound when the phone is in silent mode.

To set an alarm to sound or not in silent mode

- 1 Select **Menu > Alarms**.
- 2 Scroll to an alarm and select **Edit**.
- 3 Scroll to the  tab.
- 4 Scroll to **Silent mode:** and select **Edit**.
- 5 Select an option.

Calendar



You can synchronise your calendar with a computer calendar, with a calendar on the web or with a Microsoft® Windows Server® (Outlook®) application.

Appointments

You can add new appointments or reuse existing appointments.

To add an appointment

- 1 Select **Menu > Organiser > Calendar**.
- 2 Select a date.
- 3 Scroll to **New entry** and select **Add**.
- 4 Enter the information and confirm each entry.
- 5 Select **Save**.

To view an appointment

- 1 Select **Menu > Organiser > Calendar**.
- 2 Select a date.
- 3 Scroll to an appointment and select **View**.

To edit an appointment

- 1 Select **Menu > Organiser > Calendar**.
- 2 Select a date.
- 3 Scroll to an appointment and select **View**.
- 4 Select **Options > Edit**.
- 5 Edit the appointment and confirm each entry.
- 6 Select **Save**.

To set when reminders should sound

- 1 Select **Menu > Organiser > Calendar**.
- 2 Select a date.
- 3 Select **Options > Advanced > Reminders**.
- 4 Select an option.



A reminders option set in **Calendar** affects a reminders option set in **Tasks**.

Notes

You can make notes and save them. You can also show a note in the standby view.

To add a note

- 1 Select **Menu > Organiser > Notes**.
- 2 Scroll to **New note** and select **Add**.
- 3 Write a note and select **Save**.

To show a note in standby

- 1 Select **Menu > Organiser > Notes**.
- 2 Scroll to a note and select **Options > Show in stby**.

To hide a note shown instandby

- 1 Select **Menu > Organiser > Notes**.
- 2 Scroll to the note shown in standby. This is marked with the icon . Select **Options > Hide in standb..**

Tasks

You can add new tasks or reuse existing tasks.

To add a task

- 1 Select **Menu > Organiser > Tasks**.
- 2 Select **New task** and select **Add**.
- 3 Select an option.
- 4 Enter details and confirm each entry.

To set when reminders should sound

- 1 Select **Menu > Organiser > Tasks**.
- 2 Scroll to a task and select **Options > Reminders**.
- 3 Select an option.

! A reminders option set in tasks affects a reminders option set in calendar.

Profiles

You can change settings such as the ring volume and vibrating alert to suit different locations. You can reset all profiles to the phone's original settings.

To select a profile

- 1 Select **Menu > Settings > General > Profiles**.
- 2 Select a profile.

To view and edit a profile

- 1 Select **Menu > Settings > General > Profiles**.
- 2 Scroll to a profile and select **Options > View and edit**.

! You cannot rename the **Normal** profile.

Time and date

To set the time

- 1 Select **Menu > Settings > General > Time & date > Time**.
- 2 Enter the time and select **Save**.

To set the date

- 1 Select **Menu > Settings > General > Time & date > Date**.
- 2 Enter the date and select **Save**.

To set the time zone

- 1 Select **Menu** > **Settings** > **General** > **Time & date** > **My time zone**.
- 2 Select the time zone you are in.

! If you select a city, **My time zone** also updates the time when daylight saving time changes.

To change the clock size displayed on the standby screen

- 1 Select **Menu** > **Settings** > **Display** > **Clock size**.
- 2 Select an option.

Themes

You can change the appearance of the screen using options such as different colours and wallpaper. You can also create new themes and download them. For more information, go to www.sonyericsson.com/fun.

To set a theme

- 1 Select **Menu** > **Settings** > **Display** > **Theme**.
- 2 Scroll to a theme and select **Set**.

Main menu layout

You can change the layout of the icons in the main menu.

To change the main menu layout

- 1 Select **Menu** > **Options** > **Layout**.
- 2 Select an option.

Ringtones

To set a ringtone

- 1 Select **Menu** > **Settings** > **Sounds & alerts** > **Ringtone**.
- 2 Find and select a ringtone.

To set the ringtone volume

- 1 Select **Menu** > **Settings** > **Sounds & alerts** > **Ring volume**.
- 2 Press the navigation key left or right to adjust the volume.
- 3 Select **Save**.

To turn off the ringtone

- Press and hold down (#*0). 📞 appears.
- ! The alarm signal is not affected.

To set the vibrating alert

- 1 Select **Menu** > **Settings** > **Sounds & alerts** > **Vibrating alert**.
- 2 Select an option.

Games

Your phone contains preloaded games. You can also download games. For more information, go to www.sonyericsson.com/fun. Help texts are available for most games.

To start a game

- 1 Select **Menu** > **Entertainment** > **Games**.
- 2 Select a game.

To end a game

- Press the End key.

Applications

You can download and run Java applications. You can also view information or set different permissions. If you cannot use Java applications, see *I cannot use Internet-based services* on page 48.

To select a Java application

- 1 Select **Menu > Organiser > Applications**.
- 2 Select an application.

To set permissions for a Java application

- 1 Select **Menu > Organiser > Applications**.
- 2 Scroll to an application and select **Options > Permissions**.
- 3 Set permissions.

Java application screen size

Some Java applications are designed for a specific screen size. For more information, contact the application vendor.

To set the screen size for a Java application

- 1 Select **Menu > Organiser > Applications**.
- 2 Scroll to an application and select **Options > Screen size**.
- 3 Select an option.

To set a Java™ application as a wallpaper

- 1 Select **Menu > Settings > Display**.
- 2 Select **Wallpaper > Application**.
- 3 Select a Java application.

- ! You can only see the Java applications that have support for wallpaper.

Antivirus

Antivirus identifies and removes applications you install on your phone that become infected by viruses. It automatically scans applications during installation. When an infected application is detected, you can delete or release the infected application. You can select a 30-day free evaluation or enter a subscription number. We recommend that you update the antivirus application with the latest virus protection frequently. You need the correct Internet settings in your phone to use this function.

- ! Our inclusion or your use of antivirus software does not ensure that your use of this product will be free from exposure to viruses, malware or other harmful software.

To turn on Antivirus scanning

- 1 Select **Menu > Settings > General > Security > Antivirus**.
- 2 Follow the instructions to use the setup wizard.

To turn off Antivirus scanning

- 1 Select **Menu > Settings > General > Security > Antivirus > Virus scan**.
- 2 Select **Off**.

PIN codes

SIM protection

This lock only protects your subscription. Your phone will work with a new SIM card. If the lock is on, you have to enter a PIN (Personal Identity Number).

If you enter your PIN incorrectly three times in a row, the SIM card is blocked and you need to enter your PUK (Personal Unblocking Key). Your PIN and PUK are supplied by your network operator.

To unblock the SIM card

- 1 When **PIN blocked** appears, enter your PUK and select **OK**.
- 2 Enter a new four-to-eight-digit PIN and select **OK**.
- 3 Re-enter the new PIN and select **OK**.

To edit the PIN

- 1 Select **Menu > Settings > General > PIN codes > SIM protection > Change PIN**.
 - 2 Enter your PIN and select **OK**.
 - 3 Enter a new four-to-eight-digit PIN and select **OK**.
 - 4 Re-enter the new PIN and select **OK**.
- ! If **Codes do not match** appears, you entered the new PIN incorrectly. If **Incorrect PIN** appears, you entered the old PIN incorrectly.

To use the SIM card lock

- 1 Select **Menu > Settings > General > PIN codes > SIM protection > Protection**.
- 2 Select an option.
- 3 Enter your PIN and select **OK**.

Phone protection

You can stop unauthorised use of your phone. Change the default phone lock code (0000) to any four-to-eight-digit personal code.

- ! It is important that you remember your new code. If you forget it, you need to take your phone to your local Sony Ericsson retailer.

To use the phone lock

- 1 Select **Menu > Settings > General > PIN codes > Phone protection > Protection**.
 - 2 Select an option.
 - 3 Enter the phone lock code and select **OK**.
- 💡 When **Automatic** phone protection is activated the phone protection code must be entered when another SIM card is inserted.

To unlock the phone

- When **Phone locked** appears, enter your phone lock code and select **OK**.

To change the phone lock code

- 1 Select **Menu > Settings > General > PIN codes > Phone protection > Change code**.
- 2 Enter the old code and select **OK**.
- 3 Enter the new code and select **OK**.
- 4 Repeat the code and select **OK**.

IMEI number

Keep a copy of your IMEI (International Mobile Equipment Identity) number in case your phone is stolen.

To view your IMEI number

- Press [*] , [#] , [0] , [6] , [#] .

Troubleshooting

Some problems can be fixed using Update Service. Using Update Service on a regular basis will optimise the phone's performance. See *Updating your phone using a computer* on page 35.

Some problems will require you to call your network operator.

For more support go to www.sonyericsson.com/support.

Common questions

Where can I find the regulatory information such as my IMEI number if I cannot turn on my phone?



I have problems with memory capacity or the phone is working slowly

Restart your phone every day to free memory or do a **Master reset**.

Master reset

If you select **Reset settings**, the changes that you have made to settings will be deleted.

If you select **Reset all**, your settings and content, such as contacts, messages, pictures, sounds and downloaded games, will be deleted. You may also lose content that was in the phone at purchase.

To reset the phone

- 1 Select **Menu > Settings > General > Master reset**.
- 2 Select an option.
- 3 Follow the instructions that appear.

What do I do if the phone freezes or hangs?

Press and hold down the volume down key and the power key simultaneously for 10 seconds.

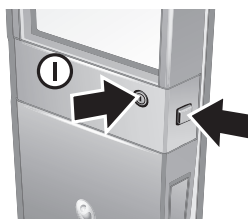

No battery icon appears when I start charging the phone

It may take a few minutes before the battery icon appears on the screen.

Some menu options appear in grey

A service is not activated. Contact your network operator.

I cannot use Internet-based services

Your subscription does not include data capability. Settings are missing or incorrect.

You can download settings using the **Settings downl.** or from www.sonyericsson.com/support.

To download settings

- 1 Select **Menu > Settings > User help > Settings downl.**
- 2 Follow the instructions that appear.



This feature might not be available in all markets. Contact your network operator or service provider for more information.

I cannot send messages from my phone

To send messages, you need to set a service centre number. The number is supplied by your service provider and is usually saved on the SIM card. If the number of your service centre is not saved on your SIM card, you must enter the number yourself.

To send most picture messages, you must set an MMS (Multimedia Messaging Service) profile and the address of your message server. If no MMS profile or message server exists, you can receive all the settings automatically from your network operator, using the Settings download, or go to www.sonyericsson.com/support.

To enter a service centre number

- 1 Select **Menu > Settings > Connectivity > Message settings > Text message** and scroll to **Service centre**. The number is shown if it is saved on the SIM card.
- 2 If there is no number shown, select **Edit**.
- 3 Scroll to **New serv. centre** and select **Add**.
- 4 Enter the number, including the international “+” sign and country code.
- 5 Select **Save**.

To select an MMS profile

- 1 Select **Menu > Settings > Connectivity > Message settings > Multimedia msg.**
- 2 Select an existing profile or create a new one.

To set the message server address

- 1 Select **Menu > Settings > Connectivity > Message settings > Multimedia msg.**
- 2 Scroll to a profile and select **Options > Edit**.
- 3 Scroll to **Message server** and select **Edit**.
- 4 Enter the address and select **OK > Save**.

The phone does not ring or rings too softly

Make sure that **Silent mode** has not been set to **On**. See *To turn off the ringtone* on page 43.

Check the ringtone volume. See *To set the ringtone volume* on page 43.

Check the profile. See *To select a profile* on page 42.

Check the divert call options. See *To divert calls* on page 18.

The phone cannot be detected by other devices using Bluetooth wireless technology

You have not turned the Bluetooth function on. Make sure that the visibility is set to **Show phone**. See *To turn on the Bluetooth function* on page 32.

I cannot synchronise or transfer content between my phone and the computer, when using a USB cable.

The software or the USB drivers have not been properly installed. Go to www.sonyericsson.com/support to read Feature guides which contain detailed installation instructions and troubleshooting sections.

Error messages

Insert SIM

There is no SIM card in your phone or you may have inserted it incorrectly.

See *To insert the SIM card* on page 4.

The SIM card connectors need cleaning. If the card is damaged, contact your network operator.

Insert correct SIM card

Your phone is set to work only with certain SIM cards. Check if you are using the correct operator SIM card.

Incorrect PIN/Incorrect PIN2

You have entered your PIN or PIN2 incorrectly.

Enter the correct PIN or PIN2 and select **OK**.

PIN blocked/PIN2 blocked

You have entered your PIN or PIN2 code incorrectly three times in a row.

To unblock, see *SIM protection* on page 45.

Codes do not match

Codes that you have entered do not match. When you want to change a security code, for example your PIN, you have to confirm the new code. See *SIM protection* on page 45.

No network

- Your phone is in flight mode. See *Flight mode* on page 40.
- Your phone is not receiving any network signal, or the received signal is too weak. Contact your network operator and make sure that the network has coverage where you are.
- The SIM card is not working properly. Insert your SIM card in another phone. If this works, it is probably your phone that is causing the problem. Please contact the nearest Sony Ericsson service location.

Emerg. calls only

You are within range of a network, but you are not allowed to use it. However, in an emergency, some network operators allow you to call the international emergency number 112. See *Emergency calls* on page 13.

PUK blocked. Contact operator.

You have entered your personal unblocking key code (PUK) incorrectly 10 times in a row.

Legal information

Sony Ericsson X5

This User guide is published by Sony Ericsson Mobile Communications AB or its local affiliated company, without any warranty. Improvements and changes to this User guide necessitated by typographical errors, inaccuracies of current information, or improvements to programs and/or equipment, may be made by Sony Ericsson Mobile Communications AB at any time and without notice. Such changes will, however, be incorporated into new editions of this User guide. All rights reserved.

©Sony Ericsson Mobile Communications AB, 2009

Publication number: 1231-2901.1

Your mobile phone has the capability to download, store and forward additional content, e.g. ringtones. The use of such content may be restricted or prohibited by rights of third parties, including but not limited to restriction under applicable copyright laws. You, and not Sony Ericsson, are entirely responsible for additional content that you download to or forward from your mobile phone. Prior to your use of any additional content, please verify that your intended use is properly licensed or is otherwise authorized. Sony Ericsson does not guarantee the accuracy, integrity or quality of any additional content or any other third party content. Under no circumstances will Sony Ericsson be liable in any way for your improper use of additional content or other third party content.

Smart-Fit Rendering is a trademark or a registered trademark of ACCESS Co., Ltd.

Bluetooth is a trademark or a registered trademark of Bluetooth SIG Inc. and any use of such mark by Sony Ericsson is under license.

The Liquid Identity logo, Xperia and TrackID are trademarks or registered trademarks of Sony Ericsson Mobile Communications AB.

TrackID™ is powered by Gracenote Mobile MusicID™. Gracenote and Gracenote Mobile MusicID are trademarks or registered trademarks of Gracenote, Inc.

Sony and "make.believe" are trademarks or registered trademarks of Sony Corporation.

Media Go is a trademark or registered trademark of Sony Media Software and Services.

microSD is a trademark or a registered trademark of SanDisk Corporation.

PictBridge is a trademark or registered trademark of Canon Kabushiki Kaisha Corporation.

YouTube and the YouTube logo are trademarks or registered trademarks of Google, Inc.

SyncML is a trademark or registered trademark of Open Mobile Alliance LTD.

Ericsson is a trademark or registered trademark of Telefonaktiebolaget LM Ericsson.

Mac is a trademark of Apple Computer, Inc., registered in the U.S. and other countries.

Adobe Photoshop Album Starter Edition is a trademark or registered trademark of Adobe Systems Incorporated in the United States and/or other countries.

Microsoft, Windows, Outlook, Windows Vista, Windows Server and ActiveSync are registered trademarks or trademarks of Microsoft Corporation in the United States and/or other countries.

This product is protected by certain intellectual property rights of Microsoft. Use or distribution of such technology outside of this product is prohibited without a license from Microsoft.

Content owners use Windows Media digital rights management technology (WMDRM) to protect their intellectual property, including copyrights. This device uses WMDRM software to access WMDRM-protected content. If the WMDRM software fails to protect the content, content owners may ask Microsoft to revoke the software's ability to use WMDRM to play or copy protected content. Revocation does not affect unprotected content. When you download licenses for protected content, you agree that Microsoft may include a revocation list with the licenses. Content owners may require you to upgrade WMDRM to access their content. If you decline an upgrade, you will not be able to access content that requires the upgrade.

This product is licensed under the MPEG-4 visual and AVC patent portfolio licenses for the personal and non-commercial use of a consumer for (i) encoding video in compliance with the MPEG-4 visual standard ("MPEG-4 video") or the AVC standard ("AVC video") and/or (ii) decoding MPEG-4 or AVC video that was encoded by a consumer engaged in a personal and non-commercial activity and/or was obtained from a video provider licensed by MPEG LA to provide MPEG-4 and/or AVC video. No license is granted or shall be implied for any other use. Additional information including that relating to promotional, internal and commercial uses and licensing may be obtained from MPEG LA, L.L.C. See <http://www.mpegla.com>. MPEG Layer-3 audio decoding technology licensed from Fraunhofer IIS and Thomson.

Java, JavaScript and Java-based trademarks and logos are trademarks or registered trademarks of Sun Microsystems, Inc. in the U.S. and other countries.

End-user license agreement for Sun Java Platform, Micro Edition.

1. Restrictions: Software is confidential copyrighted information of Sun and title to all copies is retained by Sun and/or its licensors. Customer shall not modify, decompile, disassemble, decrypt, extract, or otherwise reverse engineer Software. Software may not be leased, assigned, or sublicensed, in whole or in part.

2. Export Regulations: This product, including any software or technical data contained in or accompanying the product, may be subject to import and export regulations of the European Union, the United States and other countries. The user and any possessor of the product agrees to comply strictly with all such regulations and acknowledges that it is their responsibility to obtain any required licenses to export, re-export, or import this product. Without limiting the foregoing, and as an example, the user and any possessor of the product: (1) must not knowingly export or re-export Products to destinations identified pursuant to Articles in Chapter II of European Council Regulation (EC) 1334/2000; (2), must comply with U.S. government Export Administration Regulations ("EAR", 15 C.F.R. §§ 730-774, <http://www.bis.doc.gov/>) administered by Department of Commerce, Bureau of Industry and Security; and (3) must comply with economic sanctions regulations (30 C.F.R. §§ 500 et. seq., <http://www.treas.gov/offices/enforcement/ofac/>) administered by the U.S. Department of Treasury, Office of Foreign Assets Control. The user and any possessor of the product may not transport or deliver the product, its accessories or separate software to any country, region, entity or person prohibited by these regulations.

Restricted Rights: Use, duplication or disclosure by the United States government is subject to the restrictions as set forth in the Rights in Technical Data and Computer Software Clauses in DFARS 252.227-7013(c) (1) (ii) and FAR 52.227-19(c) (2) as applicable.

Other product and company names mentioned herein may be the trademarks of their respective owners.

Any rights not expressly granted herein are reserved.

All illustrations are for illustration only and may not accurately depict the actual phone.

Index

A	
activity menu	11
alarms	40
answering service	17
antivirus	44
applications	44
appointments	41
audio book	27
automatically checking for email	23
B	
backing up and restoring	33
battery	
capacity	6
charging	6
Bluetooth™ wireless technology	32
bookmarks	36
business card	16
C	
calendar	41
call divert	18
call list	14
call numbers in message	21
call time	19
caller-specific ringtones	15
calls	
accepting	19
answering and rejecting	13
emergency	13
international	13
making and receiving	13
putting on hold	18
recording	29
conference calls	18
contacts	
adding phone contacts	14
default contacts	14
groups	16
Smart search	15
conversations	22
costs	5
D	
date	42
download	
files	37
download	
settings	48
E	
email	22
emergency numbers	13
F	
file manager	30
file transfers	37
flight mode	40
G	
games	43
groups	16
H	
handsfree	17, 26
help	6
hiding number	20
I	
IMEI number	45
Internet	37
bookmarks	36
security and certificates	37
settings	48
Smart-Fit Rendering™	37
K	
keypad lock	10
keys	4
L	
language	11
lock	
keypad	10
SIM card	45
M	
master reset	47
Media Go™	31
Media memory	11
media transfer	31
memory	11
memory status	16
menu overview	9
messages	
email	22
picture	21
text	21
voice	22
microphone	13
<i>MMS See picture messages</i>	
model name	6
music player	26
my numbers	19
my phone number	6
N	
navigating menus	10
notes	41
O	
online	
music	28
video clips	28
P	
pan and zoom	
web pages	37
PC Companion	31
PC Suite	39
phone	
turning on	5
phone memory	6
phone name	32
picture messages	21
PIN	5, 45
playlists	27
power saving	33
profiles	42
protection	
phone	45
PUK	45
push email	23
Q	
Quick text input	11, 12

R	
radio	28
recording	
listening to	29
restricted dialling	19
ringtones	43
setting	43
roaming	5
S	
screen icons	8
search	
on web pages	37
selection keys	10
setting	
ringtones	43
settings	
download	48
Internet	48
shortcuts	11
web browser	36
SIM card	
copying to/from	15
inserting	4
lock and unblocking	45
Smart-Fit Rendering™	37
SMS <i>See text messages</i>	
SOS <i>See emergency numbers</i>	
sound recorder	29
speed dialling	16
standby	5
notes	42
streaming	28
synchronising	39
T	
tasks	42
text messages	21
theme	43
time	42, 43
time zone	43
TrackID™ technology	28
transfer method	
Bluetooth™ wireless technology	32
mass storage mode	32
Media Transfer Protocol (MTP)	31
USB cable	30
transferring	
music	31
photos	31
sound	33
Transferring content	30
turning on/off	
Bluetooth™ function	32
phone lock	45
SIM lock protection	45
U	
updating phone software	
Update Service	35
USB cable	30, 31, 32
V	
video ringtones	43
voice control	17
voice messages	22
voicemail	17
volume	
ear speaker	13
ringtone	43
W	
web browser	
Smart-Fit Rendering™	37
web pages history	37