

Panasonic[®]

Operating Instructions for advanced features

Digital Camera

Model No. **DMC-LS6**

LUMIX

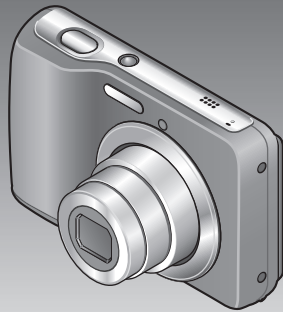

Before use, please read these instructions completely.



Contents

Before use

Cautions on handling this unit.....	4
Standard Accessories	6
Names and Functions of Main Parts....	7
Cursor button	7

Preparations

About the batteries	8
Guidelines for the number of recordable pictures and operating time.....	8
Inserting and removing the card (optional)/the batteries.....	10
Remaining battery and memory capacity....	12
Picture save destination (cards and built-in memory)	12
Recording capacity guidelines (pictures/recording time)	13
Setting the clock.....	14

Basics

Taking pictures with automatic settings [Intelligent Auto] Mode.....	16
Using zoom	18
Taking motion pictures [Motion Picture] Mode.....	19
Viewing your pictures [Normal Play]	20
Watching motion pictures	21
Viewing as list (Multi Playback)	22
Deleting pictures	23
To delete multiple (up to 50) or all pictures.....	23
Setting the menu	24
Using the [Setup] menu	26
[Clock Set].....	26
[Beep].....	26
[Volume].....	26
[Auto Power Off].....	26
[Light Freq.].....	26
[Auto Review].....	27
[Reset].....	27
[Version Disp.].....	27
[Format].....	28
[Language].....	28

Recording

Taking pictures with your own settings
[Normal Picture] Mode 29
 Recording Mode list 29

Aligning the focus 30

Changing recording information
display 31

Taking pictures with flash..... 32

Taking pictures with the self-timer ... 34

Taking pictures with Exposure
Compensation..... 35

Taking pictures according to the scene
[Scene Mode] 36
 [Portrait]..... 37
 [Self Portrait] 37
 [Scenery] 37
 [Panorama Assist] 38
 [Sports]..... 38
 [Night Portrait] 39
 [Night Scenery]..... 39
 [Food]..... 39
 [Party]..... 39
 [Baby] 40
 [Sunset]..... 40
 [High Sens.]..... 40
 [Fireworks]..... 41
 [Beach]..... 41
 [Snow] 41

Using the [Rec] menu..... 42
 [Picture Size]..... 42
 [Rec Quality] 43
 [Sensitivity] 43
 [White Balance] 44
 [AF Mode]..... 45
 [Digital Zoom] 46
 [Burst]..... 46
 [Color Mode]..... 47
 [Red-Eye Removal] 47
 [Stabilizer] 47
 [Date Stamp] 48
 [Clock Set]..... 48

Playback/Editing

Different playback methods
(Playback Mode) 49
 [Slide Show] 50
 [Category Selection]..... 51

Using the [Playback] menu..... 52
 [Resize] 52
 [Protect]..... 54
 [Copy]..... 55

Connecting with other devices

Using with your PC..... 56
 Using "PHOTOfunSTUDIO" to copy pictures
 to your computer 58

Printing 59
 Printing multiple pictures 60
 Print with date 61
 Making print settings on the camera 62

Others

List of LCD monitor displays..... 63

Message displays 65

Q&A Troubleshooting 67

Usage cautions and notes 73

Specifications 77

Cautions on handling this unit

■ Camera handling

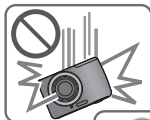

Keep the camera away from excessive vibration, force, or pressure.

- Avoid using the camera under the following conditions, which may damage the lens, LCD monitor, or camera body. This may also cause the camera to malfunction or prevent recording.
 - Dropping or hitting the camera against a hard surface
 - Sitting down with the camera in your pants pocket or forcing it into a full bag
 - Adding accessories to the camera strap
 - Pushing with excessive force on the lens or LCD monitor

The camera is not dust resistant, splash resistant, or waterproof.

Avoid using the camera in places with excessive dust or sand, or where water can come into contact with the camera.

- Avoid using the camera under the following conditions, which present a risk that sand, water, or foreign material may enter the camera through the lens or openings around buttons. Be especially careful, because these conditions may damage the camera and such damage may not be repairable.
 - In extremely dusty or sandy places
 - In the rain or by the shore, where the camera may be exposed to water

■ Condensation (lens fogging)

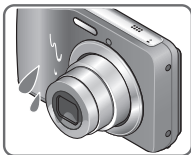

- Condensation may occur when the camera is exposed to sudden changes of temperature or humidity. Avoid these conditions, which may make the lens dirty, cause mould, or damage the camera.
- If condensation does occur, turn off the camera and wait about two hours before using it. Once the camera adjusts to the surrounding temperature, fogging will clear naturally.

■ Always take a test shot first

Before important events when you will use the camera (at weddings, for example), always take a test shot to make sure that pictures and sound record correctly.

■ No compensation for missed shots

We cannot compensate for missed shots if technical problems with the camera or card prevent recording.

■ Carefully observe copyright laws

Unauthorised use of recordings which contain works with copyright for purposes other than personal use is prohibited under copyright law. Recording of certain material may be restricted even for the purpose of personal use.

■ Also refer to “Usage cautions and notes” (→73)

Standard Accessories

Check that all the accessories are supplied before using the camera.

For details on the accessories, refer to Basic Operating Instructions.

- The accessories and their shape will differ depending on the country or area where the camera was purchased.
- LR6/AA alkaline batteries or HR6/AA rechargeable Ni-MH (nickel metal hydride) batteries is indicated as battery (or batteries) in the text.
- SD Memory Card, SDHC Memory Card and SDXC Memory Card are indicated as card in the text.
- Please dispose of all packaging appropriately.
- Keep small parts in a safe place out of the reach of children.

■ Optional accessories

- Memory cards are optional. You can record or play back pictures on the built-in memory when you are not using a card.
- Consult the dealer or your nearest Service Centre if you lose the supplied accessories. (You can purchase the accessories separately.)

Names and Functions of Main Parts

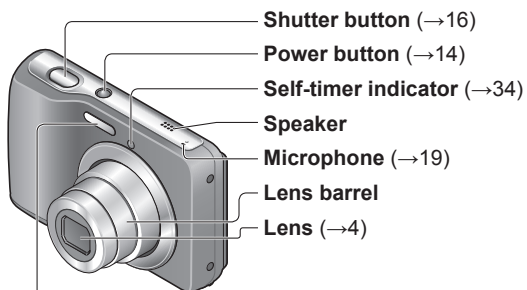

Flash (→32)

Tripod receptacle

- Ensure that the tripod is stable.

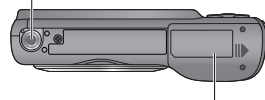

Card/Battery door (→10)

LCD monitor (→63)

[MODE] button (→29, 49)

Cursor button

Playback button (→20)

[/] (Delete/Return) button (→23)

Zoom button (→18)



[DIGITAL] socket (→56, 59)

Hand strap eyelet

We recommend using the supplied hand strap to avoid dropping the camera.

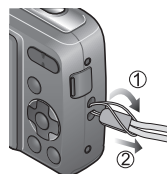

Cursor button

[MENU/SET] (menu display/set) (→24)

Left cursor button (◀)
 • Self-timer (→34)

Down cursor button (▼)
 • Changing information display (→31)

Up cursor button (▲)
 • Exposure Compensation (→35)

Right cursor button (▶)
 • Flash (→32)

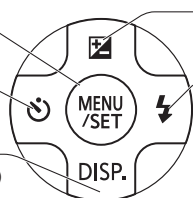

● In this manual, the button that is used is shaded or indicated by ▲▼◀▶.

- The illustrations and screens in this manual may differ from the actual product.
- Some methods of holding the camera may block the speaker, making it difficult to hear the beep, etc.

About the batteries

■ About batteries that you can use with this unit

LR6/AA alkaline batteries or optional HR6/AA rechargeable Ni-MH (nickel metal hydride) batteries can be used with this unit.

- EVOLTA (EVOIA) batteries (Panasonic battery) can also be used.
- The following batteries cannot be used.

Manganese batteries, lithium batteries, nickel batteries, Ni-Cd batteries, Oxymide batteries

If these batteries are used, the following problems may occur: battery leakage, incorrect display of remaining battery power, failure to turn on camera, damage to data written to built-in memory or card, and other troubles.

- Never use batteries such as those indicated below.
- Batteries with all or part of their covering peeled off, or batteries with flat ⊖ poles.

Guidelines for the number of recordable pictures and operating time

The number of recordable pictures or available operating time may vary according to surrounding environment and usage conditions. Figures may be reduced if flash, zoom, or other functions are used frequently, or in colder climates.

	Supplied batteries or optional Panasonic alkaline batteries	Fully-charged Panasonic Ni-MH batteries (optional, when the battery capacity is 1950 mAh)
Number of recordable pictures	Approx. 160 pictures	Approx. 320 pictures
Recording time	Approx. 80 min.	Approx. 160 min.
Playback time	Approx. 480 min.	Approx. 640 min.

● Recording conditions by CIPA standard

- CIPA is an abbreviation of [Camera & Imaging Products Association].
- [Normal Picture] Mode.
- Temperature: 23 °C/Humidity: 50%RH when LCD monitor is on.
- Using a Panasonic SD Memory Card (32 MB).
- Using the supplied batteries
- Starting recording 30 seconds after the camera is turned on. (When the Optical Image Stabiliser function is set to [ON].)
- Recording once every 30 seconds with full flash every second recording.
- Perform a zoom operation every recording (W end → T end, or T end → W end)
- Turning the camera off every 10 recordings and leaving it until the temperature of the batteries decreases.

Number reduced if intervals are longer – e.g. to approx. one quarter for 2-minute intervals under the above conditions.

About the batteries

Please note that the performance of alkaline batteries significantly decreases in low temperature conditions.

(When the temperature is 0 °C)

	Supplied batteries or optional Panasonic alkaline batteries	Fully-charged Panasonic Ni-MH batteries (optional, when the battery capacity is 1950 mAh)
Number of recordable pictures	Approx. 50 pictures	Approx. 240 pictures
Recording time	Approx. 25 min.	Approx. 120 min.
Playback time	Approx. 200 min.	Approx. 500 min.

- The number of recordable pictures, recording time, and playback time vary, depending on the storage and operating conditions of the batteries and the brand and type of batteries.
- We recommend turning off the camera frequently between recording sessions to make the batteries last longer. If you will be using the camera for long periods of time, the use of rechargeable Ni-MH batteries is recommended.
- If the available battery power is significantly reduced even when fully charged Ni-MH batteries are used, the batteries have reached the end of their life. Please purchase new batteries.
- Do not use a damaged or dented battery (especially connectors), e.g. by dropping (can cause faults).

Inserting and removing the card (optional)/the batteries

- 1** Slide the card/battery door out (①) before opening the door (②) as illustrated



- 2** Insert the batteries and card, making sure that their orientation is correct

- Batteries: Insert the batteries all the way with correct orientation of \oplus and \ominus poles.
- Card: Insert all the way firmly until it clicks.

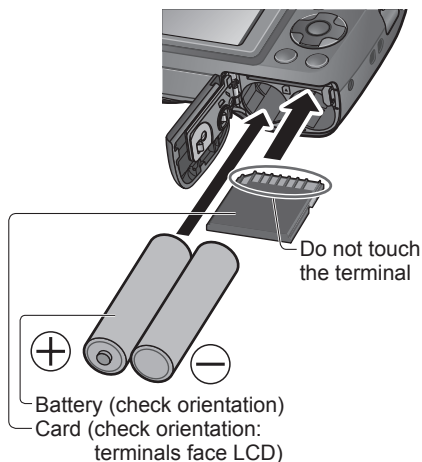

- 3** Close the card/battery door and slide the door inward until it locks firmly

Inserting and removing the card (optional)/the batteries

■ To remove

Before removing the card or batteries, turn off the camera and wait until the indication on the LCD monitor turns off completely.

(Otherwise, this unit may no longer operate normally, the card itself may become damaged or recorded pictures may be lost.)

• To remove batteries:

Tilt the camera and catch the batteries in your hand. Be careful not to drop them.

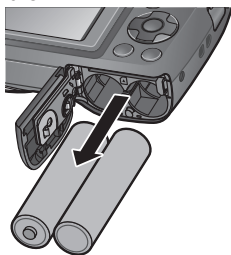

• To remove card:

Press the centre of the card and pull the card straight toward you. Be sure not to drop the batteries.

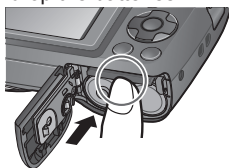

- Be sure to remove the batteries if you are not using the camera for a long period of time. Batteries may be hot immediately after use. Turn off the camera and wait until the battery temperature lowers before removing them.
- The clock settings may reset if batteries are removed from the camera for 24 hours or more.
- Always use two new batteries of the same type and brand when replacing batteries.
- Keep the Memory Card out of reach of children to prevent swallowing.

Inserting and removing the card (optional)/the batteries

Remaining battery and memory capacity

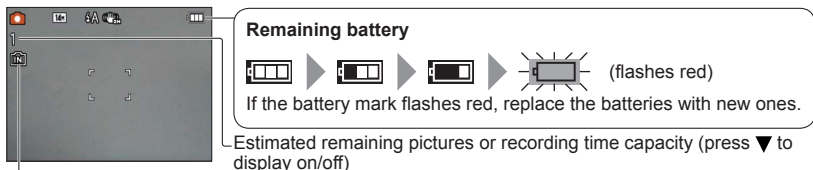

Displayed when no card is inserted (pictures will be saved to built-in memory)

When in operation

(Card) or (Built-in memory) are illuminated red.

While the light remains lit, an operation is taking place, such as picture writing or reading. While the light is lit, do not turn off the power or remove battery, card, as this can cause data loss or damage.

Keep the camera away from vibrations, impact, or static electricity. Should any of these cause camera operation to be terminated, attempt to perform the operation again.

Picture save destination (cards and built-in memory)

Pictures will be saved to a card if one is inserted, or to the built-in memory if not.

■ Built-in memory (Approx. 10 MB)

- Pictures may be copied between cards and the built-in memory (→55).
- The access time for the built-in memory may be longer than the access time for a card.
- [QVGA] in [Rec Quality] can only be available to record motion pictures in the built-in memory.

■ Compatible memory cards (optional)

The following SD standard-based cards (Panasonic brand recommended)

Type of Card	Capacity	Notes
SD Memory Cards	8 MB – 2 GB	<ul style="list-style-type: none">• Can be used with devices compatible with the respective formats.• Before using SDXC Memory Cards, check that your computer and other devices support this type of card. http://panasonic.net/avc/sdcard/information/SDXC.html• Only the cards listed on the left with the given capacities are supported.• Using a card of SD Speed "Class 6"* or above is recommended for recording motion pictures.
SDHC Memory Cards	4 GB – 32 GB	
SDXC Memory Cards	48 GB, 64 GB	

* SD speed class refers to a specification for sustained write speeds. Confirm the SD speed by checking the card label or other card related materials.

(Example)



Inserting and removing the card (optional)/the batteries

- Please reformat the card with this camera if it has already been formatted with a computer or another device. (→28)
- If the write-protect switch is set to “LOCK”, the card cannot be used to record or delete pictures, and it cannot be formatted.
- It is recommended that you copy important pictures to your computer (as electromagnetic waves, static electricity, or faults may cause data to be damaged).
- Latest information:
<http://panasonic.jp/support/global/cs/dsc/> (This Site is English only.)



Switch (LOCK)

Recording capacity guidelines (pictures/recording time)

The number of pictures you can take and the recording time varies in proportion to card capacity (and depending on recording conditions and type of card).

■ Recording picture capacity (still pictures)

[Picture Size]	Built-in memory	2 GB	32 GB	64 GB
4:3 14M	1	270	4470	8800
4:3 5M	3	730	11940	23010
4:3 0.3M	37	7920	141620	263250

- When the number of recordable pictures exceeds 99,999, “+99999” is displayed.

■ Recording time capacity (motion pictures)

[Rec Quality]	Built-in memory	2 GB	32 GB	64 GB
[HD]	—	10m50s	2h56m00s	5h51m00s
[VGA]	—	23m50s	6h24m00s	12h47m00s
[QVGA]	19s	1h2m00s	16h46m00s	23h59m00s

([h], [m] and [s] indicate “hour”, “minute” and “second”.)

- Motion pictures can be recorded continuously for up to 15 minutes. Also, continuous recording exceeding 2 GB is not possible. Remaining time for continuous recording is displayed on the screen.

Setting the clock

The clock is not set when the camera is shipped.

1 Press the Power button

The power is turned on.
If the language select screen is not displayed, proceed to step 4.

2 Press [MENU/SET] while the message is displayed



3 Press ▲ ▼ to select the language, and press [MENU/SET]

4 Press [MENU/SET]

5 Press ◀ ▶ to select the items (year, month, day, hour, minute, display order or time display format), and press ▲ ▼ to set



Select the setting item



Change the values and settings



Select either [24hrs] or [AM/PM] for the time display format.

Select the display order for the day, month, and year ([M/D/Y], [D/M/Y], or [Y/M/D]).

• To cancel → Press [⏪ / ⏩].

6 Press [MENU/SET]

7 Confirm the setting and press [MENU/SET]

- To return to the previous screen, press [⏪ / ⏩].
- Turn on power again and check time display.
(Time and date can be displayed by pressing ▼ several times.)



To change time setting

Select [Clock Set] from [Setup] or [Rec] menu, perform **5** and **6**.

- If approximately 5 hours have elapsed after installing the batteries in the camera, the clock settings will be retained for about 24 hours even if the batteries are removed.

- If the clock is not set, the correct date cannot be printed when you order a photo studio to print the picture, or when you stamp the date on the pictures with [Date Stamp].
- If the clock is set, the correct date can be printed even if the date is not displayed on the screen of the camera.

Taking pictures with automatic settings

[Intelligent Auto] Mode

Recording Mode: **iA**

Optimum settings are made automatically from information such as “face,” “brightness,” and “distance” just by pointing the camera at the subject, meaning that clear pictures can be taken without the need to make settings manually.

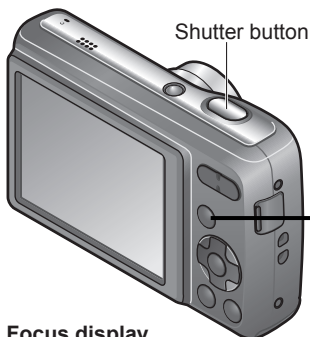

1 Display the screen for Recording Mode selection



2 Select **iA** [Intelligent Auto] Mode

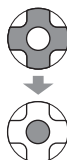

3 Take pictures



Press halfway
(press lightly to focus)



Press fully
(press the button all the way to record)

Focus display

(When focus is aligned: illuminated
When focus is not aligned: flashing)



The type of scene detected is indicated by a blue icon for two seconds

■Holding the camera

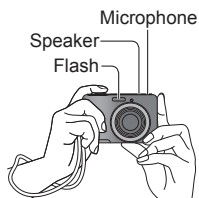

- To avoid camera shake, hold it with both hands keeping your arms close to your body and standing with your feet slightly apart.
- Do not touch the lens.
- Do not block the flash.
Do not look at it from close range.
- Try to hold the camera steady when you press the shutter button.
- **Be careful not to block the microphone or the speaker.**
- We recommend the use of the hand strap to avoid dropping the camera.

■To set flash











Select either **iA** or **SCN**.



- When **iA** is selected, the type of flash automatically changes according to the subject and brightness. (→32)
- **iA** and **SCN** indicate that the Red-Eye Reduction function is activated.
- The shutter speed is slower in **SCN** and **SCN**.

■ Automatic Scene Detection

Camera identifies the scene when pointed at the subject, and makes optimum settings automatically.

	People are detected
	Scenery is detected
	A close-up shot is detected
	People and night scenery are detected (Only when  is selected)
	Night scenery is detected
	When the scene does not correspond to any of the conditions above

When  or  is detected, Face Detection is activated, and the focus and exposure are adjusted for the recognised faces.

- Depending on recording conditions, different scene types may be determined for the same subject.
- If undesired scene type is selected, we recommend manually selecting the appropriate Recording Mode.
- We recommend using a tripod and the self-timer with  and .

-
- The following menu items may be set in [Intelligent Auto] Mode:

- [Rec] menu: [Picture Size]^{*1}, [Burst], [Color Mode]^{*1}
- [Setup] menu^{*2}: [Clock Set], [Beep], [Light Freq.], [Language]

^{*1} Items that may be set differ from other Recording Modes.

^{*2} Other items in the [Setup] menu will reflect settings made in other Recording Modes.

- The settings for the following functions are fixed:

- [Auto Power Off]: [5 MIN.] • [Auto Review]: [ON] • [Sensitivity]: [AUTO]
- [White Balance]: [AWB] • [AF Mode]:  (Face Detection)^{*3}
- [Red-Eye Removal]: [ON] • [Stabilizer]: [ON]

^{*3}  (9-area-focusing) when face cannot be recognised

- The following functions cannot be used:

[Exposure], [Digital Zoom]

Using zoom

Recording Mode:

“Optical Zoom” offers 5 x magnification. You can zoom in even closer without the loss of picture quality by lowering the picture size and using “Extra Optical Zoom.”
For zooming in even closer, “Digital Zoom” (→46) is available.



1 Zoom In/Out

Capture a wider area (wide-angle) Enlarge the subject (telephoto)

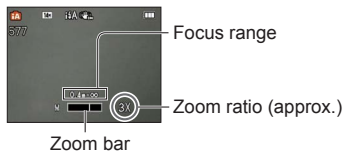

● Focus after adjusting the zoom.

Optical Zoom and Extra Optical Zoom (EZ)

Automatically switches to “Optical Zoom” when using maximum Picture Size (→42), and to “Extra Optical Zoom” (for further zooming) otherwise. (EZ is short for “Extra Optical Zoom.”)

• Optical Zoom



• Extra Optical Zoom



● Extra Optical Zoom system

When the recording pixel level is set to [3 M] (corresponding to 3 million pixels), 3 million pixels of the available pixel level in the centre of the CCD are used in recording, enabling higher magnification.

● The zoom ratio and the zoom bar displayed on the screen are estimates.

● Extra Optical Zoom cannot be used in the following cases:

Motion Picture, [High Sens.] in Scene Mode

Taking motion pictures [Motion Picture] Mode

Recording Mode: 



1 Display the screen for Recording Mode selection



2 Select [Motion Picture] Mode

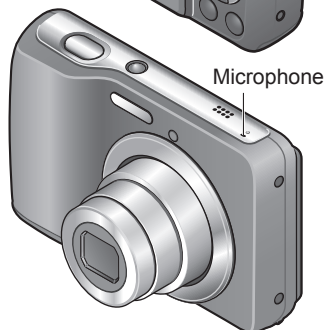
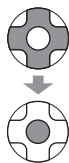

3 Start recording



Press halfway
(adjust the focus)



Press fully
(start recording)

- Immediately release the shutter button after pressing it all the way.
- The focus and zoom will remain as they were at the beginning of recording.

Remaining recording time (approx.)

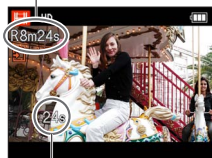

Elapsed recording time

4 End recording



Press fully

- Do not block the microphone.
- Depending on the type of card used, a card-access display may appear for a while after motion picture recording. This is not a fault.
- In [AF Mode],  (9-area-focusing) is fixed.
- [Stabilizer] does not function while recording motion pictures.
- When there is no space left to store the motion picture, recording automatically ends. Additionally, recording in progress may be stopped, depending on the card used.

Viewing your pictures [Normal Play]

Playback Mode: 

When a card is in the camera, pictures are played back from the card, and without a card, pictures are played back from the built-in memory.

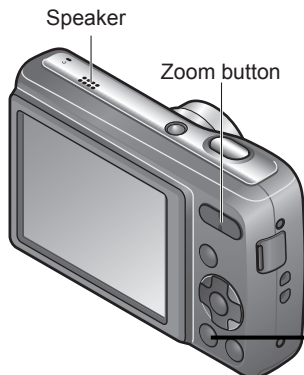

1 Press the Playback button



- Press again to enter the Recording Mode.

2 Scroll through pictures



Previous Next

Picture number/Total pictures





File number

- Press the shutter button to switch to Recording Mode.



■ To enlarge (Playback Zoom)



 
Press the T side of the zoom button



Current zoom position (displayed for 1 sec.)

- Each time the T side of the zoom button is pressed, the magnification increases. It moves through four levels after 1x: 2x, 4x, 8x, and 16x. (The picture quality displayed becomes successively lower.)
- To reduce zoom → Press the W side of the zoom button
- Move zoom position →  

- Some pictures edited on a computer may not be viewed on this camera.
- This camera is compliant with the unified DCF (Design rule for Camera File system) standard formulated by the Japan Electronics and Information Technology Industries Association (JEITA), and with Exif (Exchangeable image file format). Only files that are DCF-compliant can be played back.

Watching motion pictures

1 Select the motion picture and start playback

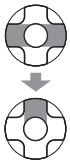

Motion picture recording time*

* When playback starts, the elapsed playback time is displayed in the top right of the screen.

Example: After 3 minutes and 30 seconds: [3m30s]

■ Operations during Motion Picture Playback



▲: Pause/Play

[MENU/SET]: Stop

◀: Fast rewind (2 steps)

Single-frame rewind (while paused)

▶: Fast forward (2 steps)

Single-frame forward (while paused)

- Press ▲ during fast rewind or fast forward to return to the normal playback speed.
- The volume can be adjusted with the zoom button.

- Motion pictures recorded on other devices may not be played correctly.
- Motion pictures can be viewed on your computer using "PHOTOfunSTUDIO" on the supplied CD-ROM or "QuickTime."

Viewing as list (Multi Playback)

Playback Mode:

You can view 12 (or 30) pictures at once (Multi Playback).



1 Press the Playback button



2 Set to multiple screen display



The display changes each time the W side is pressed

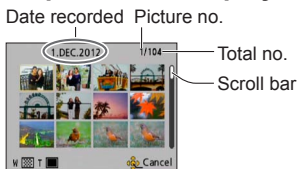

(12 screens)



(30 screens)

■ To restore

Press the T side of the zoom button

■ To change from 12/30-screen display to single-screen display

Select picture with ▲▼◀▶ and press [MENU/SET]

● Pictures displayed with [!] cannot be played back.

Deleting pictures

Playback Mode: 

Pictures will be deleted from the card if the card is inserted, or from the built-in memory if the card is not inserted. (Deleted pictures cannot be recovered.)



1 Press to delete the displayed picture



2 Select [Yes]

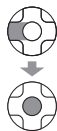

• Do not turn off the power during deletion.

To delete multiple (up to 50) or all pictures

(after step **1**)

2 Select type of deletion



• To use [Delete All]
→ go to step **5**

4 Select [OK]



3 Select the pictures to delete
(Repeat)

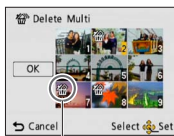
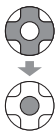

• To release
→ Press
[MENU/
SET]
again

 Picture selected

5 Press **◀** to select [Yes],
and then press [MENU/
SET]

• May take time depending on
number of pictures deleted.

- Use batteries with sufficient power.
- Pictures cannot be deleted in the following cases:
 - Protected pictures
 - Card switch is in "LOCK" position.
 - Pictures not of DCF standard (→20)

Setting the menu

■ About the menu screen

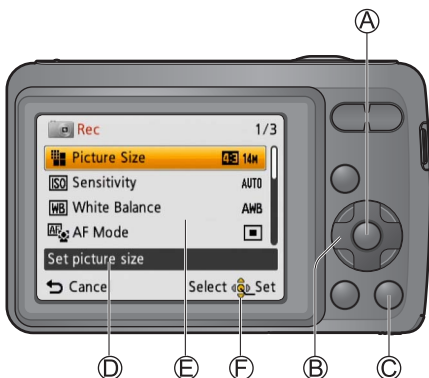

Buttons used in menu operations

- Ⓐ: [MENU/SET]
- Ⓑ: Cursor button
- Ⓒ: [⏏ / ↵] (Delete/Return) button

Menu screen configuration

- Ⓓ: Menu description
- Ⓔ: Menu items
- Ⓕ: Operation guide

■ Menu operation flow

Displaying the menu screen

Selecting the menu type

Select the item

Changing the settings

Exiting the menu screen

■ Menu type

[Setup] menu

Making the camera more convenient to use

- Enables you to specify clock settings, sound volume, and so on to make the camera easier to use.

[Rec] menu (Recording Mode only)

Changing picture preferences

- Enables you to specify colour, sensitivity, pixel level, and other settings.

[Playback] menu (Playback Mode only)

Using your pictures

- Enables you to specify picture protection, resizing, and other settings for pictures you have taken.

Refer to the procedure example below when operating the [Setup] menu, [Rec] menu and [Playback] menu.

Example: Changing [AF Mode] in the [Rec] menu in [Normal Picture] Mode

1 Press [MENU/SET]

The menu options screen is displayed.

2 Press ◀▶ to select [Rec], and then press [MENU/SET]

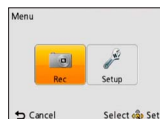

3 Press ▲▼ to select [AF Mode], and then press [MENU/SET]

Ⓒ: Pages

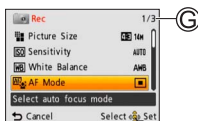

4 Press ▲▼ to select a setting, and then press [MENU/SET]

The selected setting is set.

• To cancel → Press [⏪ / ⏩]

Ⓓ: Settings

Ⓘ: Selected setting

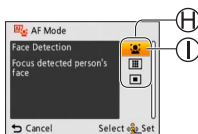

5 Press [⏪ / ⏩] several times









The menu closes and the monitor returns to the previous screen.



- The menu types and items that are displayed vary according to the mode.
- The setting methods vary depending on the menu item.
- In Recording Mode, the menu screen can also be exited by pressing the shutter button halfway.

Using the [Setup] menu



[Clock Set], [Auto Review] and [Auto Power Off] are important for clock setting and battery life. Please check these before use.

For details about the setting procedure in the [Setup] menu. (→24)

Item	Settings, Notes
 [Clock Set] (→14)	Set time, date, and display format.
 [Beep] Adjust volume of beep sounds.	 /  /  : Low/High/Mute
 [Volume] Adjust volume of sound from speakers (7 levels).	[0] / [1] / [2] / [3] / [4] / [5] / [6]
 [Auto Power Off] The camera turns off automatically after a specified period of inactivity.	[2 MIN.] / [5 MIN.] / [10 MIN.] / [OFF] <ul style="list-style-type: none"> • To restore → Turn on the power again. • Cannot be used in the following cases: When connected to computer/printer, during motion picture recording/playback, during Slide Shows • Specific periods apply in the following situations. [Intelligent Auto] Mode: [5 MIN.], and when a Slide Show is paused: [10 MIN.]
 [Light Freq.] Correct flickers on the LCD monitor.	[50Hz] / [60Hz] If the LCD monitor flickers when you record pictures under lighting such as fluorescent or LED lighting fixture, set the utility frequency of the area where you are using.

Item	Settings, Notes
 [Auto Review] Automatically display still pictures immediately after taking them.	[ON] (Automatically displays for 2 seconds.)/ [OFF] <ul style="list-style-type: none"> • Fixed to [ON] in [Intelligent Auto] Mode. • Auto review occurs immediately after taking still pictures in [Burst] mode, or [Panorama Assist] in Scene Mode, regardless of settings. • Motion pictures cannot be automatically reviewed.
 [Reset] Reset to the default settings.	[Reset Rec. settings?]
	[Reset setup parameters?] <ul style="list-style-type: none"> • When [Setup] settings are reset, [Age] setting in [Baby] Scene Mode is also reset. • Folder numbers and clock settings will remain unchanged.
 [Version Disp.] Check the version of the camera firmware.	Current version is displayed.

● For details about the setting procedure in the [Setup] menu. (→24)

Item	Settings, Notes
 [Format] Use when [Built-In Memory Error] or [Memory Card Error] appears, or when formatting the built-in memory or card. When a card/built-in memory is formatted, the data cannot be restored. Check the content of the card/built-in memory carefully before formatting.	<ul style="list-style-type: none"> • Confirm that the batteries have sufficient remaining power. When formatting the built-in memory, remove the cards. (Only inserted card will be formatted if present; built-in memory will be formatted if no card is inserted.) • Always format cards with this camera. • All protected pictures and other picture data will be deleted. • Do not turn off power or perform other operations during formatting. • Formatting the built-in memory may take several minutes. • Consult the dealer or your nearest Service Centre if format cannot be successfully completed.
 [Language] Change display language.	Set the language displayed on the screen.

● For details about the setting procedure in the [Setup] menu. (→24)

Taking pictures with your own settings

[Normal Picture] Mode

Recording Mode: 

Using the [Rec] menu to change settings and set up your own recording environment.

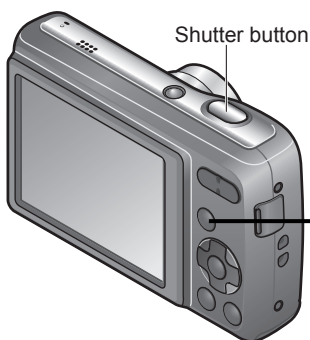

1 Display the screen for Recording Mode selection



2 Select  [Normal Picture] Mode



3 Take a picture



Press halfway
(press lightly to
focus)



Press fully
(press the button all
the way to record)





- If a warning is displayed about jitter, use [Stabilizer], a tripod, or [Selftimer].
- If aperture value or shutter speed is displayed in red, correct exposure has not been achieved. Use flash or change [Sensitivity] settings.



Jitter alert
display

Aperture value Shutter speed

Recording Mode list

	[Intelligent Auto] Mode	Take pictures with automatic settings.	(→16)
	[Normal Picture] Mode	Take pictures with your own settings.	-
	[Scene Mode]	Take pictures according to scene.	(→36)
	[Motion Picture] Mode	Take motion pictures.	(→19)

Aligning the focus

Useful when subject is not in the centre of picture.

1 First adjust focus according to subject

Align the AF area with the subject



Hold down halfway



Focus display

(When focus is aligned: illuminated
When focus is not aligned: flashing)

AF area

(When focus is aligned: green
When focus is not aligned: red)

2 Return to desired composition



Press fully



AF area

- Subjects/environments which may make focusing difficult:
 - Fast-moving or extremely bright objects, or objects with no colour contrast.
 - Taking pictures through glass or near objects emitting light. In the dark, or with significant jitter.
 - When too close to object or when taking pictures of both distant and close objects together in the same picture.

■ Focus range

Distance between the lens and the subject



15 cm
(0.49 feet)

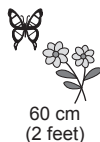

60 cm
(2 feet)



∞

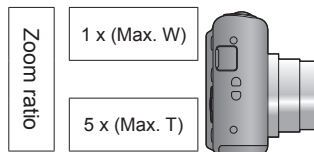

- The focus display flashes and beep sounds when focus is not aligned.
Use the focus range displayed in red as a reference.
Even if the focus display is lit, the camera may be unable to bring the subject into focus if it is out of range.
- AF area is displayed larger in dark conditions or when using Digital Zoom.



Focus range

Changing recording information display

You can switch between the various types of information shown on the LCD monitor, such as recording information.

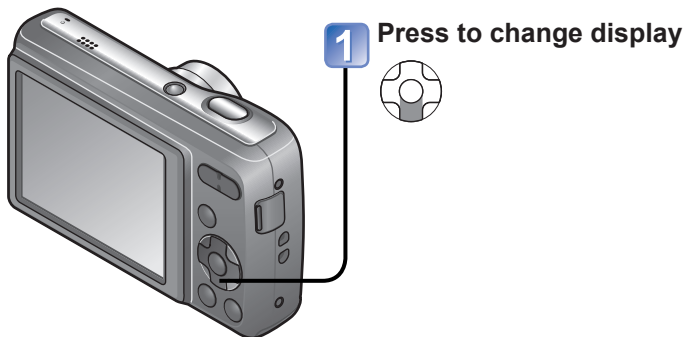

● In Recording Mode

Recording information



No display

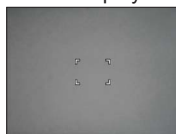

● In Playback Mode

Picture information



Picture information + Recording information



No display



- For motion picture or Slide Show playback, the operational guidance information is either displayed or not displayed on the LCD monitor.

Taking pictures with flash

Recording Mode: SCN



1 Display [Flash]



2 Select the desired type



(Can also be selected with ►.)



Type, operations		Uses
[Auto]	<ul style="list-style-type: none"> Automatically judges whether or not to flash 	Normal use
[Auto/Red-Eye]*	<ul style="list-style-type: none"> Automatically judges whether or not to flash (reduce red-eye) 	Taking pictures of subjects in dark places
[Forced Flash On]	<ul style="list-style-type: none"> Always flash 	Taking pictures with backlight or under bright lighting (e.g. fluorescent)
[Forced On/Red-Eye]*	<ul style="list-style-type: none"> Always flash (reduce red-eye) 	
[Slow Sync./Red-Eye]*	<ul style="list-style-type: none"> Automatically judges whether or not to flash (reduce red-eye; slow shutter speed to take brighter pictures) 	Taking pictures of subjects against a nightscape (tripod recommended)
[Forced Flash Off]	<ul style="list-style-type: none"> Never flash 	Places where flash use is prohibited

* When [Red-Eye Removal] is activated in the Recording menu, the icon is displayed, red-eye is automatically detected, and the still picture data is corrected. (Only when [AF Mode] is set to (Face Detection).)

■ Available types in each mode

(○: Available, -: Not available, ◻: Default setting)

	📷	iA	[Scene Mode]										
			📷	📷	📷	👤	📷	📷	📷	📷	📷	📷	📷
⚡A	○	○*1	○	○	○	-	○	-	○	○	-	○	
⚡A◻	○	-	○	○	-	-	-	-	○	-	-	-	
⚡	○	-	○	○	○	-	○	-	○	○	○	○	
⚡◻	-	-	-	-	-	-	-	○	-	-	-	-	
⚡S◻	-	-	-	-	-	○	-	○	-	-	-	-	
📷	○	○	○	○	○	○	○	○	○	○	○	○	

*1 Set to ⚡A, ⚡A◻, ⚡S◻ or ⚡S according to the subject and brightness.

• The flash cannot be used in Motion Picture Mode and in these Scene Modes:



• Scene Mode flash settings are restored to default when Scene Mode is changed.

■ The available flash range when [Sensitivity] setting is AUTO

W side (Max.)	Approx. 0.6 m (2 feet) - 4.6 m (15 feet)
T side (Max.)	Approx. 0.6 m (2 feet) - 2.0 m (6.6 feet)

- The flash is activated twice. Be sure to keep still until all flashing is complete.
- Shutter speeds are as follows:
 - ⚡A, ⚡A◻, ⚡, ⚡◻ : 1/60 - 1/2000th
 - ⚡S◻, 📷 : 1/8*2 - 1/2000th
- *2 Varies according to [Intelligent Auto] Mode, [Scene Mode] scene, etc.
- The effect of Red-Eye Reduction varies depending on the subject and is affected by factors such as distance to the subject, whether the subject is looking at the camera during preliminary flash, and so on. In some cases, the effect of Red-Eye Reduction may be negligible.
- **Do not touch or look at the flash (→7) from close distances (i.e. a few cm). Do not use the flash at close distances to other subjects (heat/light may damage subject).**
- Flash settings may be changed when changing Recording Mode.
- Scene Mode flash settings are restored to default when Scene Mode is changed.
- When [AUTO] is set in [Sensitivity], the ISO Sensitivity is automatically set in a range up to 800.
- No pictures may be taken if these marks (e.g. ⚡A◻) are flashing (flash is charging).
- Insufficient light may prevent appropriate exposure or white balance.
- Flash effect may not be fully achieved with high shutter speeds.
- Flash charging may take time if battery is low, or if using flash repeatedly.

Taking pictures with the self-timer

Recording Mode:   SCN

We recommend using a tripod. This is also effective for correcting jitter when pressing the shutter button, by setting the self-timer to 2 seconds.



1 Display [Selftimer]



2 Select time duration



(Can also be selected with ◀)

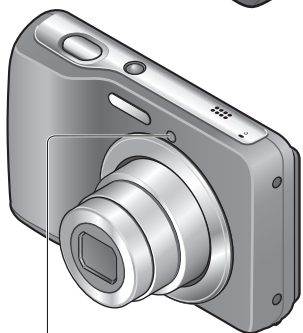

Self-timer indicator

3 Take a picture

Press the shutter button fully to make the self-timer indicator flash and start recording after the preset time.



- To cancel while in operation
→ Press [MENU/SET]

- Focus will be automatically adjusted immediately before recording if shutter button is pressed fully.
- In [Self Portrait] Scene Mode, [10sec.] is unavailable.

Taking pictures with Exposure Compensation

Recording Mode:  SCN 

Corrects exposure to obtain optimum exposure (for example, if there is difference between brightness of object and background). Depending on the brightness, this may be impossible in some cases.

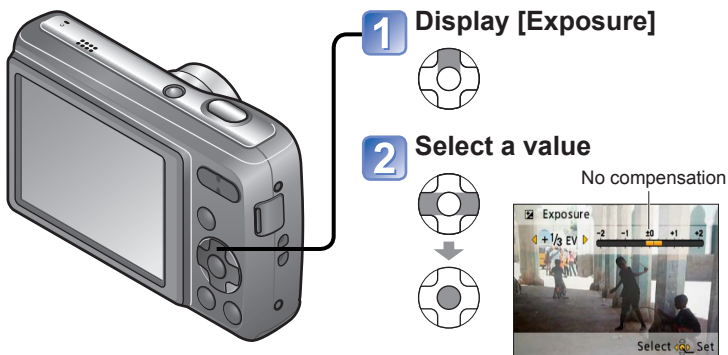

- After exposure adjustment, the adjustment value ( +1/3 for example) is displayed.
- The Exposure Compensation value you set is retained even after the camera is turned off.

Taking pictures according to the scene

[Scene Mode]



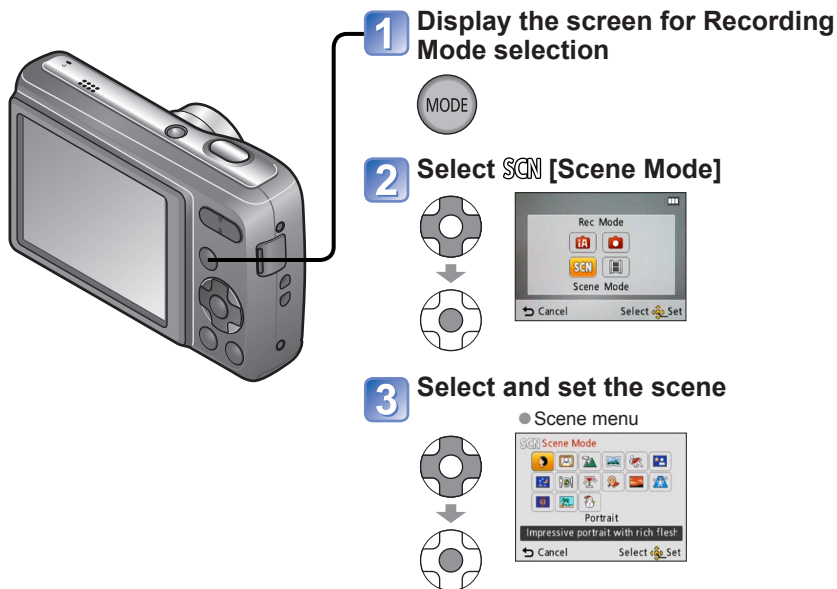

Recording Mode: SCN

Using [Scene Mode] enables you to take pictures with optimum settings (exposure, colouring, etc.) for given scenes.





- Selecting a Scene Mode inappropriate for the actual scene may affect the colouring of your picture.
- Following [Rec] menu settings will be automatically adjusted and cannot be selected manually.
[Sensitivity], [Color Mode]

Taking pictures according to the scene [Scene Mode]





 [Portrait]	<p>Improves the skin tone of subjects for a healthier appearance in bright daylight conditions.</p> <p>Tips</p> <ul style="list-style-type: none">• The closer the zoom is positioned to the T (telephoto) edge and the closer the camera is brought to the subject, the greater the effect will be.
 [Self Portrait]	<p>Take pictures of yourself.</p>  <p>Tips</p> <ul style="list-style-type: none">• Use of the 2-second self-timer is recommended when the shutter speed is slow or jitter occurs easily.
 [Scenery]	<p>Takes clear pictures of wide, distant subjects.</p>

- How to select a scene. (→36)
- Using flash in Scene Modes. (→33)



 [Panorama Assist]	<p>Use the supplied software to join multiple pictures into a single panorama picture.</p> <ol style="list-style-type: none"> ① Use ▲ ▼ to select the recording direction, and press [MENU/SET] to set. ② Take the picture. ③ Select [Next], and press [MENU/SET] to set. <ul style="list-style-type: none"> • Alternatively, press the shutter button halfway. • You can take pictures again by selecting [Retake]. ④ Change the composition and take the picture so that a part of the picture overlaps with the previous picture. <div style="display: flex; align-items: center; margin-top: 10px;">  <div style="margin-left: 10px;"> <ul style="list-style-type: none"> • To take more pictures, select [Next] and repeat steps ③ and ④. </div> </div> <p style="margin-top: 10px;">Section of picture that was taken last time</p> ⑤ After you finish taking pictures, select [Exit], and press [MENU/SET] to set. <p>Tips</p> <ul style="list-style-type: none"> • Use a tripod. • When it is dark, use the self-timer to record pictures. <p>Notes</p> <ul style="list-style-type: none"> • The focus, zoom, Exposure Compensation, White Balance, shutter speed, and ISO Sensitivity are all fixed at the setting for the first picture. • Panorama picture stitching cannot be performed by this camera. Use the software on the supplied CD-ROM "PHOTOfunSTUDIO" to make the pictures you record into a panorama still picture with your computer.
 [Sports]	<p>Takes pictures of scenes with fast movement, e.g. sports.</p> <p>Tips</p> <ul style="list-style-type: none"> • Stand at least 5 m (16 feet) away.

- How to select a scene. (→36)
- Using flash in Scene Modes. (→33)

Taking pictures according to the scene [Scene Mode]



 <p>[Night Portrait]</p>	<p>Takes pictures of people and nightscapes with close to actual brightness.</p> <p>Tips</p> <ul style="list-style-type: none">• Use flash.• Subject should not move.• Tripod, self-timer recommended.
 <p>[Night Scenery]</p>	<p>Takes clear pictures of night scenes.</p> <p>Tips</p> <ul style="list-style-type: none">• Tripod, self-timer recommended. <p>Notes</p> <ul style="list-style-type: none">• Shutter speed may slow down up to 8 seconds.• After recording, the shutter may stay closed (up to 8 seconds) to process the signal. This is not a malfunction.
 <p>[Food]</p>	<p>Takes natural-looking pictures of food.</p>
 <p>[Party]</p>	<p>Brighten subjects and background in pictures of indoor events, such as weddings.</p> <p>Tips</p> <ul style="list-style-type: none">• Stand approx. 1.5 m (4.9 feet) away.• Zoom: Wide (W side)• Use flash.• Tripod, self-timer recommended.

- How to select a scene. (→36)
- Using flash in Scene Modes. (→33)

 [Baby]	<p>Uses weak flash to bring out skin colours.</p> <ul style="list-style-type: none"> • To record age <ol style="list-style-type: none"> ① Select [Age], and press [MENU/SET]. ② Select [SET] with ▲▼, and press [MENU/SET]. ③ Set birthday with ▲▼◀▶, and press [MENU/SET]. ④ Select [Exit] with ▼, and press [MENU/SET]. <p>Tips</p> <ul style="list-style-type: none"> • Make sure [Age] is [ON] before taking a picture. <p>Notes</p> <ul style="list-style-type: none"> • You can perform print settings on your computer using the software "PHOTOfunSTUDIO" on the supplied CD-ROM when you print [Age] on a still picture.
 [Sunset]	<p>Takes clear pictures of scenes such as sunsets.</p>
 [High Sens.]	<p>Prevents blurring of subject in dark, indoor conditions.</p> <p>Select the aspect ratio and the picture size with ▲▼ and press [MENU/SET].</p>

- How to select a scene. (→36)
- Using flash in Scene Modes. (→33)

Taking pictures according to the scene [Scene Mode]

 [Fireworks]	<p>Takes clear pictures of fireworks in the night sky.</p> <p>Tips</p> <ul style="list-style-type: none">• Stand at least 10 m (33 feet) away.• Tripod recommended. <p>Notes</p> <ul style="list-style-type: none">• Shutter speed is fixed to 1/4. (Setting of shutter speed changes if exposure compensation is operated)
 [Beach]	<p>Brings out the clear blues of the sky and the sea without darkening subject.</p> <p>Notes</p> <ul style="list-style-type: none">• Do not touch camera with wet hands.• Beware of sand and sea water.
 [Snow]	<p>Brings out the natural colour of snow in ski slope and mountain scenes.</p>

- How to select a scene. (→36)
- Using flash in Scene Modes. (→33)

Using the [Rec] menu

For details about the setting procedure in the [Rec] menu (→24)

[Picture Size]

Set the size (number of pixels) of still pictures. This setting determines how many pictures you can record.

■ Mode: **iA**  **SCN**

■ Settings:

Recording pixel level type		
4:3	14 M	4320×3240
4:3	10 M EZ *	3648×2736
4:3	5 M EZ	2560×1920
4:3	3 M EZ *	2048×1536
4:3	0.3 M EZ	640×480
3:2	12.5 M	4320×2880
16:9	10.5 M	4320×2432

* This setting is not available in **iA** ([Intelligent Auto] Mode).

- **4:3** **3:2** **16:9** represent the aspect ratios of the still pictures.
- Extra Optical Zoom can be used for picture sizes indicated with **EZ**.
- Extra Optical Zoom is not available in the following cases.
 - [Motion Picture] Mode
 - [High Sens.] in Scene Mode
- Mosaic effect may appear depending on subject and recording conditions.

Setting guide

Larger Picture Size	←→	Smaller Picture Size
Sharper picture		Coarser picture
Lower recording capacity		Higher recording capacity

For details about the setting procedure in the [Rec] menu (→24)

[Rec Quality]

Set the picture size of motion pictures.

■ **Mode:** 

■ **Settings:**

Picture Quality	Picture Size	No. of Frames	Picture Aspect Ratio
[HD]	1280 × 720 pixels	30 fps	16:9
[VGA]	640 × 480 pixels		4:3
[QVGA]*	320 × 240 pixels		

*[QVGA] is fixed when recording to the built-in memory.

- Depending on the motion picture recording environment, static electricity or electromagnetic waves may cause the screen to go black momentarily or noise to be recorded.
- When recording motion pictures, it is recommended to use batteries with sufficient power.
- If you attempt to play motion pictures recorded with the camera on other devices, playback may not be possible, or the picture or sound quality may be poor. Additionally, incorrect recording information may be indicated.

[Sensitivity]

Set ISO Sensitivity (sensitivity to lighting) manually.

We recommend higher settings to take clear pictures in darker locations.

■ **Mode:** 

■ **Settings:** [AUTO] / [100] / [200] / [400] / [800] / [1600]

Setting guide

[Sensitivity]	[100] ←	↔	→ [1600]
Location (recommended)	Bright (outdoors)		Dark
Shutter speed	Slow		Fast
Interference	Low		High
Jitter of the subject	Increased		Less

- [AUTO] is automatically set in a range up to 800 based on brightness.
- Scope of flash recording (→33)

For details about the setting procedure in the [Rec] menu (→24)

[White Balance]

Adjust colouring to suit light source if colours otherwise appear unnatural.

■ **Mode:** **SCN**

■ **Settings:** **[AWB]** (automatic) / (outdoor, clear sky) / (outdoor, cloudy sky) / (outdoor, shade) / (incandescent lighting) / (uses value set in SET) / SET (set manually)

[AWB] operational range:

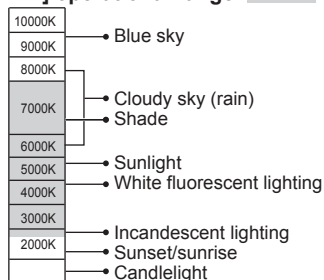

K=Kelvin colour Temperature

- Picture may appear red or blue if out of range. This function may also not work correctly even within the range if there are many light sources present.
- Under fluorescent lighting, LED lighting fixture etc., the appropriate White Balance will vary depending on the lighting type, so use [AWB] or SET.
- White Balance setting is fixed to [AWB] in the following Scene Modes: [Scenery], [Night Portrait], [Night Scenery], [Food], [Party], [Sunset], [Fireworks], [Beach], [Snow]
- If the Scene Mode is changed, the white balance setting returns automatically to [AWB].

■ **Setting White Balance manually** (SET)

- ① Select SET and press [MENU/SET].
- ② Point the camera towards a white object (e.g. paper) and press [MENU/SET].
 - White Balance is set to .
 - The White Balance you set is retained even after the power is turned off.
 - White Balance setting may not be possible if the subject is too bright or too dark. In such cases, adjust the subject to an appropriate brightness, and then set the White Balance again.

Only takes picture of white objects within frame (step ②)



For details about the setting procedure in the [Rec] menu (→24)

[AF Mode]

Method of aligning focus can be changed according to position and number of subjects.

■ **Mode:** SCN

■ **Settings:** / /

<p>Taking front-on pictures of people</p> <p> (Face Detection)</p>	<p>Detected faces (up to 11 people) and adjusts exposure and focus accordingly.</p>  <p>AF area Yellow: When the shutter button is pressed halfway, the frame turns green when the camera is focused. White: Displayed when more than one face is detected. Other faces that are the same distance away as faces within the yellow AF area are also focused.</p>
<p>Subject not centred in picture (AF area displayed only when focused)</p> <p> (9-area-focusing)</p>	<p>Automatically focuses on any of 9 points.</p>
<p>Determined position for focus</p> <p> (1-area-focusing)</p>	<p>Focuses on AF area in centre of picture. (Recommended when focus is difficult to align)</p>

- AF area becomes larger in dark locations or when using Digital Zoom, etc.
- Cannot set to "Face Detection" in the following cases:
 [Panorama Assist], [Night Scenery], [Food] Scene Modes
- If the camera misinterprets a non-human subject as a face in the "Face Detection" setting, switch to another setting.
- If faces cannot be detected such as when subjects are looking at places other than the camera or when the subject is moving rapidly, the AF mode setting switches to .

For details about the setting procedure in the [Rec] menu (→24)

[Digital Zoom]

Multiplies effect of Optical Zoom or Extra Optical Zoom by up to 4 times.
(Note that, with Digital Zoom, enlarging will decrease picture quality.)

■ **Mode:**  SCN

■ **Settings:** [ON]/[OFF]

Digital Zoom area is displayed within zoom bar on screen.



Digital Zoom area

- Zoom motion stops momentarily when entering Digital Zoom range.
- Within Digital Zoom range, AF area is displayed larger when the shutter button is pressed halfway.
- We recommend using a tripod and [Selftimer].

- The setting is fixed to [OFF] in [High Sens.] Scene Mode.
- Cannot change the setting in [Motion Picture] Mode. The setting in other Recording Mode is applied.

[Burst]

Enables a rapid succession of still pictures to be taken. Succession of still pictures taken while shutter button is held down.

■ **Mode:**   SCN

■ **Settings:**  / [OFF]

Speed	No. of pictures
Approx. 0.8 pictures/sec	Until card/built-in memory is full

- Burst speed may be reduced if ISO Sensitivity is set to high, or if shutter speed is reduced in darker locations.
- When burst is selected, the flash is disabled.
- When you record subjects in motion where there is a significant difference between light and dark areas, it may not be possible to achieve the optimal exposure.
- The setting is fixed to [OFF] in [Panorama Assist] and [Fireworks] Scene Modes.
- When [Selftimer] is set, 3 pictures are taken.

For details about the setting procedure in the [Rec] menu (→24)

[Color Mode]

Set colour effects.

■ **Mode:** 

■ **Settings:** [STANDARD]/[VIVID]* (sharper)/[B&W]/[SEPIA]



* [Normal Picture] Mode and [Motion Picture] Mode only

[Red-Eye Removal]

Automatically detects red-eye and corrects still picture data when recording with flash Red-Eye Reduction (.

■ **Mode:** 

■ **Settings:** [ON]/[OFF]

- Available only when [AF Mode] is set to  (Face Detection).
- The red-eye effect may not be corrected under certain conditions.
- When [ON] is selected,  is displayed in the flash icon.

[Stabilizer]

Automatically detects and prevents jitter.

■ **Mode:** 

■ **Settings:** [ON]/[OFF]

- The setting is fixed to [ON] in [Self Portrait] Scene Mode.
- Cases where Optical Image Stabiliser may be ineffective:
Heavy jitter, high zoom ratio (also in the Digital Zoom range), fast-moving objects, indoors or in dark locations (due to low shutter speed)

For details about the setting procedure in the [Rec] menu (→24)

[Date Stamp]

Still pictures can be taken with the recording date and time stamped on the still picture.

■ **Mode:**  SCN

■ **Settings:** [W/O TIME]/[WITH TIME]/[OFF]

- Date stamps on still pictures cannot be erased.
- The date cannot be stamped when [Burst] is set.
- The setting is fixed to [OFF] in [Panorama Assist] Scene Mode.
- Do not request date printing in store or make date printing on printer for still pictures with date stamps. (Date printing may be overlapping.)
- Cannot change the setting in [Intelligent Auto] Mode. The setting in other Recording Mode is applied.

[Clock Set]

Set the clock (→14). Same function as that in [Setup] menu.

Different playback methods (Playback Mode)

Playback Mode: 

Recorded pictures can be played back in a variety of ways.

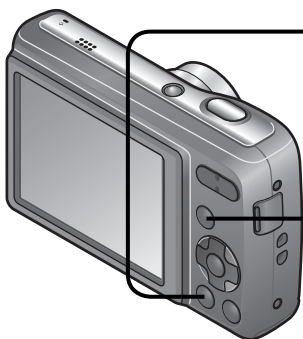

1 Press the Playback button



2 Display the screen for Playback Mode selection



3 Select the method of playback



■ [Normal Play]

(→20)

■ [Slide Show]

(→50)

■ [Category Selection]

(→51)

- When no card is inserted, pictures are played back from the built-in memory.
- After you switch from Recording Mode to Playback Mode, the Playback Mode automatically becomes [Normal Play].

For details about the switching Playback Mode procedure (→49)

[Slide Show]

Automatically plays back still pictures in order.

1 Select playback method



[All]	Playback of all still pictures
[Category Selection]	Select a category and play back. (Select category with ▲▼◀▶ and press [MENU/SET].) (→51)

2 Make sure [Start] is selected and press [MENU/SET]

■ Operations during Slide Show

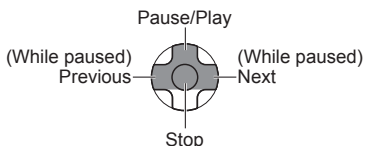

■ Changing settings such as playback duration

- ① Select [Setup] in step 2 above and press [MENU/SET]
- ② Select an item to change its setting

[Setup]	
[Duration]	[1 SEC.] / [2 SEC.] / [3 SEC.] / [5 SEC.]
[Repeat]	[ON]/[OFF]

- Motion pictures cannot be played back in a Slide Show. When the [Motion Picture] category is selected, the initial screens of motion pictures are played back as still pictures in the Slide Show.













For details about the switching Playback Mode procedure (→49)

[Category Selection]

You can narrow down the pictures displayed to view only a selected category.

1 Select a category and press [MENU/SET]



[Category]	Recording information such as Scene Modes
	[Portrait]/  /[Self Portrait]/[Night Portrait]/  /[Baby]
	[Scenery]/  /[Sunset]
	[Night Portrait]/  /[Night Scenery]/ 
	[Sports]/[Party]/[Fireworks]/[Beach]/[Snow]
	[Baby]
	[Food]
	[Motion Picture]

Using the [Playback] menu

Playback Mode: 

For details about the setting procedure in the [Playback] menu (→24)

[Resize]

Picture size can be reduced to facilitate e-mail attachment and use in webpages, etc. (Still pictures recorded at the smallest recording pixel level cannot be further reduced.)

Set-up: Press [MENU/SET] → [Playback] menu → Select [Resize]

■ [SINGLE]

1 Select [SINGLE]



2 Select still picture



3 Select size

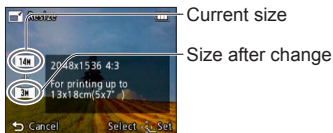

4 Select [Yes]



• After confirmation, press [ / ] to return to the menu screen.

■ [MULTI]

1 Select [MULTI] in step **1** on the previous page

2 Select size

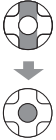

3 Select still picture (up to 50 pictures)

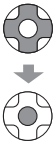

• To cancel → Press [MENU/SET] again.

4 Select [OK]

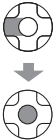

5 Select [Yes]

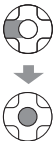

- Picture quality is reduced after resizing.
- Cannot resize the following pictures.
 - Motion pictures
 - Still pictures already stamped with the date using [Date Stamp]

For details about the setting procedure in the [Playback] menu (→24)

[Protect]

Set protection to disable picture deletion. Prevents deletion of important pictures.

Set-up: Press [MENU/SET] → [Playback] menu → Select [Protect]

1 Select [SINGLE] or [MULTI]

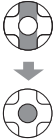

2 Select picture and make setting



- To cancel → Press [MENU/SET] again.
- After confirmation, press [Left] / [Right] to return to the menu screen.

■ To clear all

Select [CANCEL] in step 1 and select [Yes].

■ To cancel while releasing all

Press [MENU/SET].

- May not be effective when using other devices.
- Formatting will cause even protected files to be deleted.
- If the write-protect switch is set to "LOCK," pictures on the card cannot be deleted even if they are not protected with the camera setting.

For details about the setting procedure in the [Playback] menu (→24)

[Copy]

You can copy pictures between built-in memory and memory card.

Set-up: Press [MENU/SET] → [Playback] menu → Select [Copy]

1 Select the copy method (direction)



 : Copy all pictures from built-in memory to card (go to step 3).
 : Copy 1 picture at a time from card to built-in memory.





2 When selecting , press ◀▶ to select a picture, and then press [MENU/SET]

3 Select [Yes]



- To cancel → Press [MENU/SET].
- After confirmation, press  /  to return to the menu screen.



- Copying pictures may take several minutes. Do not turn off power or perform other operations during copying.
- If identical names (folder/file numbers) are present in the copy destination, a new folder for copying will be created when copying from built-in memory to card (). Identically-named files will not be copied from card to built-in memory (.
- The [Protect] setting will not be copied. Set it again after copying.
- Only pictures from Panasonic digital cameras (LUMIX) may be copied.

Using with your PC

Pictures and motion pictures can be imported from the camera to your computer by connecting the two together.

- If your computer does not support SDXC Memory Cards, a message will be displayed requesting you to format the card. (Do not format the card. This will erase recorded pictures.) If the card is not recognised, refer to the following support website: <http://panasonic.net/avc/sdcard/information/SDXC.html>

Getting Ready:

- Make sure to insert batteries with sufficient power.
- When importing pictures from the built-in memory, remove any memory cards.

Check socket direction and insert straight in.
(Damage to socket shape can lead to faulty operation.)

[Access]
(sending data)

- Do not disconnect the USB connection cable while [Access] is displayed.

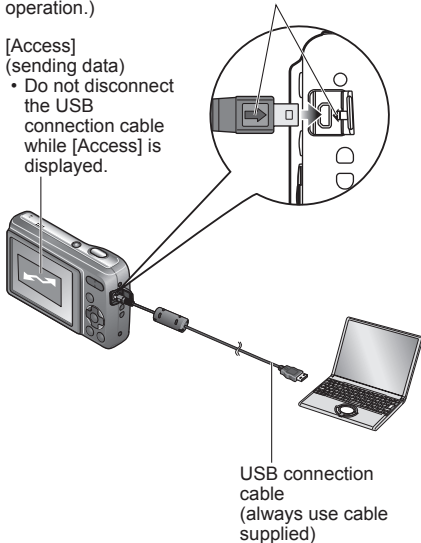

1 Connect camera to computer

- Please make sure you use the supplied USB connection cable. Use of cables other than the supplied USB connection cable may cause malfunction.

2 Select [PC] on the camera

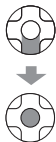

3 Operate with your computer

■ To cancel connection

Click “**Safely Remove Hardware**” in the Windows System Tray → disconnect USB connection cable → turn off camera power

You can save pictures to use on your computer by dragging and dropping folders and files into separate folders on your computer.

■ Folder and file names on computer

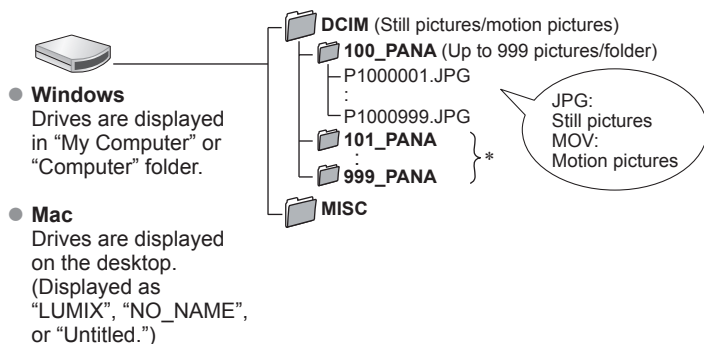

* New folders are created in the following cases:

- When pictures are added to folders containing files numbered 999.
- When using cards already containing the same folder number (for example, pictures taken with other cameras, etc.)

■ When using Windows XP, Windows Vista, Windows 7, or Mac OS X

The camera can be connected to your computer even if you select [PictBridge(PTP)] in the step 2 on the previous page.

- Only picture output can be performed from the camera. (Picture deletion can also be performed with Windows Vista and Windows 7.)
- It may not be possible to import if there are 1000 or more pictures on the card.

- Do not use any other USB connection cables except the one supplied.
- Turn off power before inserting or removing memory cards.
- If the batteries run out while transmitting, a warning beep sounds. Cancel transmission using your computer immediately. Use batteries with sufficient power.
- Some computers can read directly from the camera's memory card.
For details, see the manual for your computer.
- For more details, consult your computer operating manual.

Using “PHOTOfunSTUDIO” to copy pictures to your computer

With the “PHOTOfunSTUDIO” software on the supplied CD-ROM, a computer can be used to manage the recorded pictures.

- Main “PHOTOfunSTUDIO” functions
 - Copying recorded still pictures or motion pictures to a computer
 - Backing up still pictures or motion pictures that have been copied to a computer to media such as a DVD
 - Editing still pictures on a computer
 - Stitching still pictures recorded in Scene Mode [Panorama Assist] into a panorama
 - Attaching recorded pictures to e-mail
 - Uploading recorded pictures to YouTube or Facebook

- After importing pictures to your computer, you can print or e-mail them.

Printing

You can connect directly to a PictBridge-compatible printer for printing. Some printers can print directly from the camera's memory card. For details, see the manual for your printer.

Getting Ready:

- Make sure to insert batteries with sufficient power.
- When printing pictures from the built-in memory, remove any memory cards.
- Adjust the print quality or other settings on your printer, as needed.

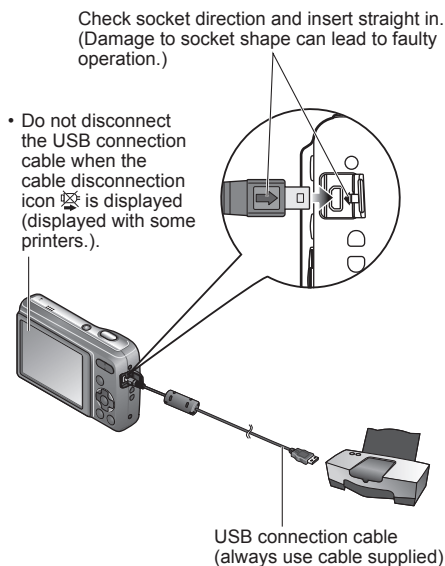

1 Connect camera to printer

- Make sure you use the supplied USB connection cable. Use of cables other than the supplied USB connection cable may cause malfunction.

2 Select [PictBridge(PTP)] on the camera

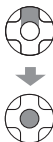

3 Press ◀▶ to select a picture to print, and then press [MENU/SET]

4 Select [Print start]

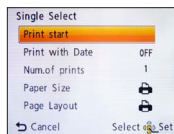

(Print settings (→62))

■ To cancel print

Press [MENU/SET].

Printing multiple pictures

1 Select [Multi Print] in step 3 on the previous page



2 Select item



- **[Multi Select]:** ① Scroll between pictures with ▲▼◀▶, select pictures with [MENU/SET] to print. (Press [MENU/SET] again to release selection.)



- **[Select All]:** Print all pictures.

3 Print (Previous page 4)

- Select [Yes] if print confirmation screen is displayed.
- An orange ● displayed during printing indicates an error message.
- Print may be divided into several times if printing a large amount of pictures. (Remaining sheets display may differ from set number.)

-
- Do not use any other USB connection cables except the one supplied.
 - Disconnect USB connection cable after printing.
 - Turn off power before inserting or removing memory cards.
 - When the batteries run out during communication, a warning beep sounds. Cancel printing and disconnect the USB connection cable. Use batteries with sufficient power.

Print with date

- Printing in store: Only recording date can be printed. Request date printing in store.
 - When printing still pictures of 16:9 Aspect Ratio, check in advance that the store can accept this size.
- Using computer: Print settings for recording date and text information can be made using the supplied CD-ROM "PHOTOfunSTUDIO."
- Using printer: Recording date can be printed by setting [Print with Date] (→62) to [ON] when connecting to a printer compatible with date printing.

Making print settings on the camera

(Make settings before selecting [Print start])

1 Select item

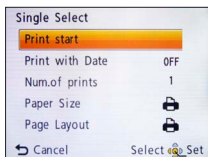

2 Select setting



Item	Settings												
[Print with Date]	[ON]/[OFF]												
[Num.of prints]	Set number of pictures (up to 999 pictures)												
[Paper Size]	<table border="0"> <tr> <td> (printer takes priority)</td> <td>[A3] (297×420 mm)</td> </tr> <tr> <td>[L/3.5"×5"] (89×127 mm)</td> <td>[10×15 cm] (100×150 mm)</td> </tr> <tr> <td>[2L/5"×7"] (127×178 mm)</td> <td>[4"×6"] (101.6×152.4 mm)</td> </tr> <tr> <td>[POSTCARD] (100×148 mm)</td> <td>[8"×10"] (203.2×254 mm)</td> </tr> <tr> <td>[16:9] (101.6×180.6 mm)</td> <td>[LETTER] (216×279.4 mm)</td> </tr> <tr> <td>[A4] (210×297 mm)</td> <td>[CARD SIZE] (54×85.6 mm)</td> </tr> </table>	(printer takes priority)	[A3] (297×420 mm)	[L/3.5"×5"] (89×127 mm)	[10×15 cm] (100×150 mm)	[2L/5"×7"] (127×178 mm)	[4"×6"] (101.6×152.4 mm)	[POSTCARD] (100×148 mm)	[8"×10"] (203.2×254 mm)	[16:9] (101.6×180.6 mm)	[LETTER] (216×279.4 mm)	[A4] (210×297 mm)	[CARD SIZE] (54×85.6 mm)
(printer takes priority)	[A3] (297×420 mm)												
[L/3.5"×5"] (89×127 mm)	[10×15 cm] (100×150 mm)												
[2L/5"×7"] (127×178 mm)	[4"×6"] (101.6×152.4 mm)												
[POSTCARD] (100×148 mm)	[8"×10"] (203.2×254 mm)												
[16:9] (101.6×180.6 mm)	[LETTER] (216×279.4 mm)												
[A4] (210×297 mm)	[CARD SIZE] (54×85.6 mm)												
[Page Layout]	(printer takes priority) / (1 picture, no border) / (1 picture, with border) / (2 pictures) / (4 pictures)												

- Items only compatible with the printer may be displayed.
- To arrange "2 pictures" or "4 pictures" in the same still pictures, set the number of prints for the still pictures to 2 or 4.
- To print to paper sizes/layouts not supported by this camera, set to and make settings on the printer. (Consult your printer's operating manual.)
- When setting [Print with Date] to [ON], check the date printing settings on the printer (printer settings may be prioritised).

List of LCD monitor displays

Press ▼ to change display (→31).

■ In recording

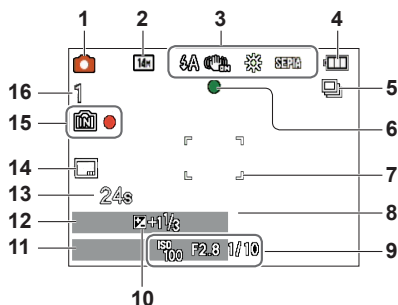

- | | |
|------------------------------------|--|
| 1 Recording Mode (→16, 19, 29, 36) | 9 ISO Sensitivity (→43) |
| 2 Picture Size (→42) | Aperture value/Shutter speed (→29) |
| Recording quality (→43) | 10 Exposure Compensation (→35) |
| 3 Flash Mode (→32) | 11 Current date/time |
| Optical Image Stabiliser (→47) | 12 Age in years/months (→40) |
| Jitter alert (→29) | 13 Elapsed recording time (→19) |
| White Balance (→44) | 14 Date Stamp (→48) |
| Colour Mode (→47) | 15 Save destination (→12) |
| 4 Battery capacity (→12) | Recording state |
| 5 Burst Mode (→46) | 16 Number of recordable pictures (→13) |
| 6 Focus (→16) | Remaining recording time (→19) |
| 7 AF area (→30) | RXXhXXmXXs* |
| 8 Self-timer Mode (→34) | |

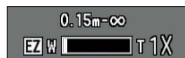

Focus range
Zoom (→18, 46)

* [h], [m] and [s] indicate "hour", "minute" and "second."

• Screens shown here are only examples. The actual display may vary.

■ In playback

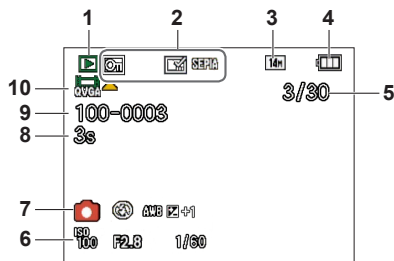

- | | |
|--|--|
| <p>1 Playback Mode (→49)</p> <p>2 Protected picture (→54)
Date Stamp (→48)
Colour Mode (→47)</p> <p>3 Picture Size (→42)</p> <p>4 Battery capacity (→12)</p> <p>5 Picture number/Total pictures (→20)
Elapsed playback time (→21)</p> <p>6 Recorded date and time
Age in years/months (→40)
ISO Sensitivity (→43)
Aperture value/Shutter speed (→29)</p> | <p>7 Recording Mode (→16, 19, 29, 36)
Flash Mode (→32)
White Balance (→44)
Exposure Compensation (→35)</p> <p>8 Motion picture recording time (→21)
XXhXXmXXs*</p> <p>9 Folder/File number (→20, 57)
Save destination (→12)</p> <p>10 Motion pictures (→21)
Cable disconnection warning icon (→59)</p> |
|--|--|

* [h], [m] and [s] indicate “hour”, “minute” and “second.”

• Screens shown here are only examples. The actual display may vary.

Message displays

Meanings and required responses to major messages displayed on LCD monitor.

[Some pictures cannot be deleted] [This picture cannot be deleted]

- Non-DCF pictures (→20) cannot be deleted.
→ Save needed data on a computer or other device, and then use [Format] on the camera. (→28)

[No additional selections can be made]

- The number of pictures that can be deleted at once has exceeded.
- The number of pictures allowing [Resize] (multiple settings) at once has exceeded.

[Please turn camera off and then on again] [System Error]

- The lens is not working correctly.
→ Turn on power again.
(Consult the dealer or your nearest Service Centre if display still remains)

[Some pictures cannot be copied] [Copy could not be completed]

- Pictures cannot be copied in the following cases:
→ Picture of same name already exists in built-in memory when copying from card.
→ File is not of DCF standard.
→ Picture taken or edited on a different device.

[Not enough space on built-in memory] [Not enough memory on the card]

- There is no space left on the built-in memory or the card. When you copy pictures from the built-in memory to the card (batch copy), the pictures are copied until the capacity of the card becomes full.

[Built-In Memory Error] [Format built-in memory?]

- Displayed when formatting built-in memory via computer, etc.
→ Reformat directly using camera. Data will be deleted.

[Memory card error. This card cannot be used in this camera. Format this card?]

- The card format cannot be used with this camera.
→ Save needed data on a computer or other device, and then use [Format] on the camera. (→28)

[Insert SD card again] [Try another card]

- Access to card has failed.
→ Insert card again.
- Try with a different card.

[Memory Card Error] [Memory card parameter error]

- Card is not of SD standard.
- When cards in capacities of 4 GB or more are used, only SDHC or SDXC Memory Cards are supported.

[Read Error]/[Write Error] [Please check the card]

- Data read has failed.
→ Check whether card has been inserted correctly (→10).
- Data write has failed.
→ Turn off power and remove card, before re-inserting and turning on power again.
- Card may possibly be damaged.
- Try with a different card.

[Motion recording was cancelled due to the limitation of the writing speed of the card]

- When recording motion picture, use a card rated with an SD speed class* of “Class 6” or higher.
* SD speed class refers to a specification for sustained write speeds.
- If recording stops even when using a card with speed of “Class 6” or faster, the data writing speed is low. We recommend backing up the data on the memory card and reformatting it. (→28)
- Motion picture recording may be automatically terminated with certain cards.

[A folder cannot be created]

- Folder numbers in use have reached 999.
→ Save needed data on a computer or other device, and then use [Format] on the camera. (→28)

Q&A Troubleshooting

Try checking these items (→67 - 72) first.

If the problem persists, performing [Reset] in the [Setup] menu may resolve the issue. (Note that except for some items such as [Clock Set], all settings are returned to their values from the time of purchase.)

Battery, power

The camera turns off immediately even with full battery power.

The remaining battery power is low even if new batteries are inserted.

- The batteries are expended.
- Depending on the battery brand and the operating temperature, the remaining battery power may not be displayed accurately.

Camera does not work even if power is turned on.

- Batteries are not inserted correctly (→10), or need recharging.

The power cuts off during use.

- The batteries are expended.
- Camera is set to [Auto Power Off]. (→26)
→ Turn on the power again.

Recording

Cannot record pictures.

- Built-in memory/card is full. → Free space by deleting unwanted pictures (→23).

Recorded pictures look white.

- Lens is dirty (fingerprints, etc.).
→ Clean lens surface with a soft, dry cloth.
- Lens is foggy (→4).

Recorded pictures are too bright/too dark.

- Adjust the exposure (→35).

2-3 pictures are taken when I press the shutter button just once.

- Camera is set to use [Burst] (→46).

Focus not aligned correctly.

- Not set to mode appropriate for distance to subject. (Focus range varies according to Recording Mode.)
- Subject outside of focus range.
- Caused by jitter or subject movement (→47).

Recorded pictures are blurred. Optical Image Stabiliser ineffective.

- Shutter speed is slower in dark locations and Optical Image Stabiliser is less effective.
→ Hold camera firmly with both hands, keeping arms close to body.
→ Set [Digital Zoom] to [OFF] and [Sensitivity] to [AUTO]. (→43, 46)

Recording (Continued)

Recorded pictures appear coarse, or there is interference.

- ISO Sensitivity is high, or shutter speed is low.
(Default [Sensitivity] setting is [AUTO] – interference may appear with indoor pictures.)
→ Lower [Sensitivity] (→43).
→ Take pictures in brighter locations.
- Camera is set to [High Sens.].
(Picture becomes slightly coarser in response to high sensitivity.)

Brightness or colouring of recorded picture different from real life.

- When recording under fluorescent or LED lighting fixture etc., increasing the shutter speed may introduce slight changes to brightness and colour. These are a result of the characteristics of the light source and do not indicate a malfunction.

Red banding may appear on the LCD monitor or part or the entire screen may have a reddish tint, when recording or pressing the shutter button halfway.

- This is a characteristic of CCD and may appear if subject contains brighter areas. Some blurring may occur around these areas, but this is not a fault. This will be recorded in motion pictures, but not in still pictures.
- We recommend keeping the screen away from strong light sources such as sunlight when taking pictures.



Motion picture recording stops midway.

- With some cards, access display may appear briefly after recording, and recording may end midway.
- When recording motion picture, use a card rated with an SD speed class* of “Class 6” or higher.
* SD speed class refers to a specification for sustained write speeds.
- If recording stops even when using a card with speed of “Class 6” or faster, the data writing speed is low. We recommend backing up the data on the memory card and reformatting it. (→28)

The beep volume is low.

- The speaker is blocked.

LCD monitor

Monitor sometimes shuts off even though power is on.

- After recording, monitor shuts off until next picture can be recorded.

Brightness is unstable.

- Aperture value is set while shutter button is pressed halfway.
(Does not affect recorded picture.)

Monitor flickers indoors.

- If the LCD monitor flickers when you record pictures under lighting such as fluorescent or LED lighting fixture, use [Light Freq.] in the [Setup] menu to set the utility frequency of the area where you are using. (→26)

Black/blue/red/green dots or interference appears. Monitor looks distorted when touched.

- This is not a fault, and will not be recorded on the actual pictures, so there is no need to worry.

Date/age is not displayed.

- The current date and [Age] are displayed for about 5 seconds in instances such as when the camera is turned on, when you switch from Playback Mode to Recording Mode, when you switch to [Baby] Scene Mode.

Flash

No flash emitted.

- Flash set to [Forced Flash Off]  (→32).
- Flash is disabled when using [Burst] or when using the following Scene Modes. [Scenery], [Panorama Assist], [Night Scenery], [Sunset], [Fireworks]

Playback

Cannot view pictures.

- Press the Playback button.
- No pictures in built-in memory or card (pictures are played from card if inserted, from built-in memory if card is not inserted).
- Camera set to [Category Selection].
→ Set Playback Mode to [Normal Play] (→49).

Folder/file number displayed as [-]. Picture is black.

- Picture edited on computer or taken with a different device.
- Batteries removed immediately after picture taken, or picture taken with low battery.
→ Use [Format] to delete (→28).

Playback (Continued)

The Playback volume and beep volume are low.

- The speaker is blocked.

White round spots like soap bubbles appear on the recorded picture.

- If you take a picture with the flash in a dark place or indoors, white round spots may appear on the picture caused by the flash reflecting particles of dust in the air. This is not a fault. A characteristic of this is that the number of round spots and their position differ in every picture.



[Thumbnail is displayed] is shown on the screen.

- The still pictures may have been recorded with another device. If so, they may be displayed with poor picture quality.

Blackened red areas in recorded pictures.

- When digital red-eye correction (ⓂA, Ⓜ, ⓂS) is operating, if a subject is recorded that has skin-coloured areas with red areas inside, the digital red-eye correction function may blacken the red areas.
→ We recommend setting the Flash Mode to ⓂA, Ⓜ, or ⓂS, or [Red-Eye Removal] to [OFF] before recording.

The sound of the recorded motion pictures sometimes breaks up.

- This unit automatically adjusts the aperture during motion picture recording. At such times, the sound may break up. This is not a malfunction.

Motion pictures recorded on this camera cannot be played on other devices.

- Motion pictures (Motion JPEG) recorded with this camera may not be played on digital cameras of other manufacturers. Additionally, motion pictures recorded with this camera cannot be played on Panasonic LUMIX digital cameras sold before July 2008. (However, motion pictures recorded with LUMIX digital cameras sold before this date can be played on this camera.)

Computer, printer**Cannot send pictures to computer.**

- Not connected correctly (→56).
- Check whether computer has recognised camera.
- Select [PC] when connecting the camera to your computer. (→56)

Computer does not recognise card (only reads built-in memory).

- Disconnect USB connection cable and reconnect with card in place.

The card is not recognised by the computer.**(You are using an SDXC Memory Card.)**

- Make sure your computer supports SDXC memory cards.
<http://panasonic.net/avc/sdcard/information/SDXC.html>
- When you insert a card, a message will be displayed requesting you to format the card, but do not format it.
- If [Access] remains displayed on the LCD monitor, turn off the camera and then disconnect the USB cable.

Cannot print when connecting to printer.

- Printer is not compatible with PictBridge.
- Set [USB Mode] to [PictBridge (PTP)]. (→59)

Cannot print the date.

- Make date printing settings before printing.
→ With supplied software: Select “with dates” within print settings.
- Use [Date Stamp] function when taking a picture. (→48)

Edges cut off pictures when printing.

- Release any trimming or edgeless printing settings on printer before printing.
(Consult printer operating manual.)
- The pictures were recorded in **16:9** aspect ratio.
→ If printing in shop, check if 16:9 sizes can be printed.

Others**Menu not displayed in desired language.**

- Change [Language] setting (→28).
-

Camera is hot.

- Camera may become a little warm during use, but this does not affect performance or quality.
-

Lens makes a clicking noise.

- When brightness changes, the lens may make a clicking noise and the monitor brightness may also change, but this is due to aperture settings being made.
(Does not affect recording.)
-

Clock is incorrect.

- Camera has been left for a long period.
→ Reset the clock (→14).
-

When using zoom, picture becomes slightly warped and the edges of the subject become coloured.

- Pictures may be slightly warped or coloured around the edges, depending on the zoom ratio, but this is not a fault.
-

File numbers are not recorded in sequence.

- File numbers are reset when new folders are created (→57).
-

File numbers have jumped backwards.

- Batteries were removed/inserted with power on.
(Numbers may jump backwards if folder/file numbers are not correctly recorded.)

Usage cautions and notes

When in use

- Camera may become warm if used for long periods of time, but this is not a fault.
- **Keep this unit as far away as possible from electromagnetic equipment (such as microwave ovens, TVs, video games etc.).**
 - If you use this unit on top of or near a TV, the pictures and/or sound on this unit may be disrupted by electromagnetic wave radiation.
 - Do not use this unit near cell phones because doing so may result in noise adversely affecting the pictures and/or sound.
 - Recorded data may be damaged, or pictures may be distorted, by strong magnetic fields created by speakers or large motors.
 - Electromagnetic wave radiation generated by microprocessors may adversely affect this unit, disturbing the pictures and/or sound.
 - If this unit is adversely affected by electromagnetic equipment and stops functioning properly, turn this unit off and remove the battery. Then reinsert the battery and turn this unit on.

Do not use this unit near radio transmitters or high-voltage lines.

- If you record near radio transmitters or high-voltage lines, the recorded pictures and/or sound may be adversely affected.
- Do not extend the supplied cord or cable.
- Do not allow camera to come into contact with pesticides or volatile substances (can cause surface damage or coating to peel).
- Never leave the camera and the batteries in a car or on a car hood in the summer. It may cause leakage of the battery electrolyte, generation of heat, and may cause a fire and the batteries to burst due to the high temperature.

Caring for your camera

To clean your camera, remove the batteries and wipe with a soft, dry cloth.

- Use a damp cloth to remove stubborn stains, before wiping again with a dry cloth.
- Do not use benzene, thinners, alcohol, or kitchen detergent, as these may damage the outer casing and finish of the camera.
- If using a chemically-treated cloth, read the supplied instructions carefully.

When not using for a while

- Turn off camera power before removing batteries and card.
- Do not leave in contact with rubber or plastic bags.
- Store together with a drying agent (silica gel) if leaving in a drawer, etc.

Memory cards

- To prevent damage to cards and data
 - Avoid high temperatures, direct sunlight, electromagnetic waves, and static electricity.
 - Do not bend, drop, or expose to strong impacts.
 - Do not touch connectors on reverse of card or allow them to become dirty or wet.
- When disposing of/transferring memory cards
 - If using the “format” or “delete” functions on your camera or computer, this only changes the file management information, and does not completely delete the data from within the memory card. When disposing of or transferring your memory cards, we recommend physically destroying the memory card itself, or using commercially available computer data erasing software to completely delete the data from the card. Data within memory cards should be managed responsibly.

LCD Monitor

- Do not press hard on the LCD monitor. This may cause uneven display and damage the monitor.
- Do not rub the LCD monitor forcefully or push on it.
- In cold climates or other situations when the camera becomes cold, the LCD monitor may be slightly less responsive than normal immediately after startup. Normal brightness will return once the internal components have warmed up.

Batteries

- Be sure to remove the batteries from the camera if you are not using it for a long period of time.
 - If the batteries are left in the camera, a small electrical current continues to flow even when the camera is turned off and the batteries will be gradually drained.
 - If the temperature is too high or low or the humidity is high, the terminals may rust causing a malfunction.
 - Be sure to store the batteries in cool (15 °C to 25 °C) location with low humidity (40%RH to 60%RH), where the temperature does not change sharply.
 - Keep batteries away from toddlers and children.
- Do not drop, throw, or subject batteries to other strong impact.
 - If you drop the batteries accidentally, make sure that the terminals have not been damaged.
 - Do not use batteries that show signs of leakage, deformation, discolouration, etc. If battery leakage occurs, remove the batteries, thoroughly wipe dry the battery compartment, and then insert new batteries or fully charged Ni-MH batteries.
- Always use the batteries in dry and clean conditions.
 - Do not immerse the batteries in water or seawater or wet the terminals.
 - If there is any foreign substance such as grease or dirt on the battery poles, the recording/playback time may become extremely short. Before inserting the batteries, carefully clean the poles with a soft dry cloth.

- Do not peel off or scratch the battery covering.
 - Do not use commercially available batteries that are entirely or partly uncovered. Do not use batteries with flat \ominus poles. Using such batteries may cause leakage, heat generation or explosion.
- Take spare batteries when going out.
 - Be aware that the recording time is reduced in low temperature conditions such as at a ski slope. Battery performance deteriorates when the ambient temperature is low (10 °C or less) and the recording/playback time may become extremely short. In particular, when using alkaline batteries, warm them in your pocket etc. before using them. Make sure that pocket heaters or metal objects such as lighters do not come into contact with the batteries when warming them in your pocket etc. The battery performance will recover when the temperature returns to normal.
 - Battery performance may vary greatly depending on the brand used, the storage life from the date of manufacture, and the storage conditions of the batteries.
 - Depending on the temperature and the conditions of use, the camera may not operate properly or the batteries may run out (the remaining battery power may not be accurately displayed). This is not a malfunction.
 - Expended batteries may temporarily recover some performance if they are left for a period of time. However, they cannot be used for an extended period. Be sure to replace them with new batteries.

Rechargeable Ni-MH batteries

- You can use Ni-MH batteries after charging them with a dedicated battery charger. However, improper handling of the batteries may cause leakage, heat generation, fire or an explosion. Observe the following.
 - If there is dirt on the battery poles, you may not be able to charge the batteries normally. Carefully clean the battery poles and battery charger terminals with a soft dry cloth.
 - Do not peel off or scratch the covering on Ni-MH batteries.
 - When the batteries are used for the first time, or after having not been used for a long period of time, they may not fully charge. This is a characteristic of Ni-MH batteries and is not a malfunction. Battery performance will return to normal after a few charges and discharges.
 - We recommend charging the batteries after they are fully discharged. If you repeat charging before they are fully discharged, battery performance may be reduced. (This is called "memory effect.")
 - If a "memory effect" occurs, continue using the batteries until the camera can no longer perform recording or playback and then charge them fully. Battery performance will be restored after a few charges and discharges.
 - Once the Ni-MH batteries have reached full charge, do not continue to charge them.
 - Over time, Ni-MH batteries naturally discharge and their performance lowers even if they are not used. If the batteries are left in the camera in this condition, they will be drained excessively and may become unusable even if they are charged again.
 - When storing the batteries for a long period of time, we recommend charging them once a year. Remove the batteries from the camera and store them again after they have been completely expended.

- Ni-MH batteries have a limited life. Battery performance gradually decreases over time as you keep using them and time goes by. If the length of time you can use the camera is extremely short even after fully charging the batteries, they may have exceeded their life span. Purchase new batteries.
- Read the operating instructions for the battery charger.

Disposing of used rechargeable batteries

- Insulate the terminals using adhesive tape etc.
- Do not disassemble the batteries.

Personal Information

If you set [Age] in [Baby] Mode, keep in mind that the camera and recorded pictures will contain personal information.

- Disclaimer
 - Data containing personal information can be altered or lost due to malfunction, static electricity, accidents, breakdowns, repairs, or other operations. Panasonic will not be liable for any damage that occurs, direct or indirect, as a result of the alteration or loss of data containing personal information.
- When ordering repairs or transferring/disposing of the camera
 - To protect your personal information, please reset the settings. (→27)
 - If any pictures are contained in the built-in memory, copy (→55) them to a memory card if necessary, and then format (→28) the built-in memory.
 - Remove the memory card from the camera.
 - When ordering repairs, the built-in memory and other settings may be returned to the initial purchase state.
 - If the above operations cannot be performed because of a camera malfunction, consult with the dealer or nearest Service Centre.

When transferring or disposing of your memory card, see “When disposing of/transferring memory cards” in the previous section.

Specifications

Power Source	DC 3 V LR6/AA Alkaline batteries (2) (supplied) DC 2.4 V HR6/AA Rechargeable Ni-MH (nickel metal hydride) batteries (2)
Power Consumption	When recording: 1.4 W When playing back: 0.8 W
Camera effective pixels	14,100,000 pixels
Image sensor	1/2.33" CCD, total pixel number 14,500,000 pixels Primary colour filter
Lens	Optical 5 x zoom f=4.7 mm to 23.5 mm (35 mm film camera equivalent: 26 mm to 130 mm)/ F2.8 (Max. W) to F6.5 (Max. T)
Image Stabiliser	Optical method
Digital Zoom	Max. 4 x
Extra Optical Zoom	Max. 10.5 x (When the picture size is set to 3 million pixels [3M] or less.)
Focus	Face Detection/9-area-focusing/1-area-focusing
Focus range	
Normal	15 cm (0.49 feet) (Wide)/0.6 m (2 feet) (Tele) to ∞
Scene Mode	There may be difference in above settings.
Shutter system	Electronic shutter + Mechanical shutter
ISO Sensitivity	AUTO/100/200/400/800/1600 [High Sens.] mode: 1600 - 6400
Shutter speed	8 to 1/2000 th
White Balance	Auto [AWB]/Daylight/Cloudy/Shade/Incandescent/White set
Exposure (AE)	AUTO (Programme AE) Exposure Compensation (1/3 EV Step, -2 EV to +2 EV)
Metering Mode	Multiple
LCD monitor	2.7" TFT LCD (4:3) (Approx. 230,400 dots) (field of view ratio about 100%)
Flash	Flash range: (ISO AUTO) Approx. 0.6 m (2 feet) to 4.6 m (15 feet) (Wide)
Microphone	Monaural
Speaker	Monaural

Specifications

Recording media	Built-in Memory (Approx. 10 MB)/SD Memory Card/ SDHC Memory Card/SDXC Memory Card
Picture size	
Still picture	When the aspect ratio setting is [4:3] 4320×3240 pixels / 3648×2736 pixels / 2560×1920 pixels / 2048×1536 pixels / 640×480 pixels When the aspect ratio setting is [3:2] 4320×2880 pixels When the aspect ratio setting is [16:9] 4320×2432 pixels
Motion pictures	1280×720 pixels* / 640×480 pixels* / 320×240 pixels 30 fps (* Only when using an SD Memory Card)
Recording file format	
Still picture	JPEG (based on Design rule for Camera File system, based on Exif 2.3 standard)
Motion pictures	QuickTime Motion JPEG (motion pictures with audio)
Interface	
Digital	USB 2.0 (High Speed) Data from the PC can not be written to the camera using the USB connection cable.
Terminal	DIGITAL: Dedicated jack (8 pin)
Dimensions	Approx. 96.5 mm (W) x 62.0 mm (H) x 27.2 mm (D) [3.8" (W) x 2.45" (H) x 1.07" (D)] (excluding the projection part)
Mass	With card and battery: Approx. 172 g (0.38 lb) Excluding card and battery: Approx. 125 g (0.28 lb)
Operating temperature	Between 0 °C and 40 °C
Operating humidity	Between 10%RH and 80%RH



- SDXC Logo is a trademark of SD-3C, LLC.
- QuickTime and the QuickTime logo are trademarks or registered trademarks of Apple Inc., used under license therefrom.
- Other names, company names, and product names printed in these instructions are trademarks or registered trademarks of the companies concerned.