

Nokia 6760 slide User Guide

Issue 2

DECLARATION OF CONFORMITY

CE 0434

Hereby, NOKIA CORPORATION declares that this RM-573 product is in compliance with the essential requirements and other relevant provisions of Directive 1999/5/EC. A copy of the Declaration of Conformity can be found at http://www.nokia.com/phones/declaration_of_conformity/.

Nokia, Nokia Connecting People, Mail for Exchange, Navi, Ovi, and Nokia Original Enhancements logo are trademarks or registered trademarks of Nokia Corporation. Nokia tune is a sound mark of Nokia Corporation. Other product and company names mentioned herein may be trademarks or tradenames of their respective owners. Reproduction, transfer, distribution, or storage of part or all of the contents in this document in any form without the prior written permission of Nokia is prohibited. Nokia operates a policy of continuous development. Nokia reserves the right to make changes and improvements to any of the products described in this document without prior notice.

This software is based in part of the work of the FreeType Team. This product is covered by one or more of the following patents: United States Patent 5,155,805, United States Patent 5,325,479, United States Patent 5,159,668, United States Patent 2232861 and France Patent 9005712.

symbian

This product includes software licensed from Symbian Software Ltd ©1998-2009. Symbian and Symbian OS are trademarks of Symbian Ltd.



Java and all Java-based marks are trademarks or registered trademarks of Sun Microsystems, Inc.

Portions of the Nokia Maps software are ©1996-2009 The FreeType Project. All rights reserved.

This product is licensed under the MPEG-4 Visual Patent Portfolio License (i) for personal and noncommercial use in connection with information which has been encoded in compliance with the MPEG-4 Visual Standard by a consumer engaged in a personal and noncommercial activity and (ii) for use in connection with MPEG-4 video provided by a licensed video provider. No license is granted or shall be implied for any other use. Additional information, including that related to promotional, internal, and commercial uses, may be obtained from MPEG LA, LLC. See <http://www.mpegla.com>.

TO THE MAXIMUM EXTENT PERMITTED BY APPLICABLE LAW, UNDER NO CIRCUMSTANCES SHALL NOKIA OR ANY OF ITS LICENSORS BE RESPONSIBLE FOR ANY LOSS OF DATA OR INCOME OR ANY SPECIAL, INCIDENTAL, CONSEQUENTIAL OR INDIRECT DAMAGES HOWSOEVER CAUSED.

THE CONTENTS OF THIS DOCUMENT ARE PROVIDED "AS IS". EXCEPT AS REQUIRED BY APPLICABLE LAW, NO WARRANTIES OF ANY KIND, EITHER EXPRESS OR IMPLIED, INCLUDING, BUT NOT LIMITED TO, THE IMPLIED WARRANTIES OF MERCHANTABILITY AND FITNESS FOR A PARTICULAR PURPOSE, ARE MADE IN RELATION TO THE ACCURACY, RELIABILITY OR CONTENTS OF THIS DOCUMENT. NOKIA RESERVES THE RIGHT TO REVISE THIS DOCUMENT OR WITHDRAW IT AT ANY TIME WITHOUT PRIOR NOTICE.

Reverse engineering of software in the device is prohibited to the extent permitted by applicable law. Insofar as this user guide contains any limitations on Nokia's representations, warranties, damages and liabilities, such limitations shall likewise limit any representations, warranties, damages and liabilities of Nokia's licensors.

The availability of particular products and applications and services for these products may vary by region. Please check with your Nokia dealer for details and availability of language options. This device may contain commodities, technology or software subject to export laws and regulations from the US and other countries. Diversion contrary to law is prohibited.

FCC/INDUSTRY CANADA NOTICE

Your device may cause TV or radio interference (for example, when using a telephone in close proximity to receiving equipment). The FCC or Industry Canada can require you to stop using your telephone if such interference cannot be eliminated. If you require assistance, contact your local service facility. This device complies with part 15 of the FCC rules. Operation is subject to the following two conditions: (1) This device may not cause harmful interference, and (2) this device must accept any interference received, including interference that may cause undesired operation. Any changes or modifications not expressly approved by Nokia could void the user's authority to operate this equipment.

/Issue 2 EN

Contents

Safety	7	Volume control.....	21
About your device.....	7	Write text with the keyboard.....	21
Office applications.....	8	Write and send messages.....	22
Network services.....	8	Active standby.....	23
Shared memory.....	8	Menu.....	23
Support	9	Indicators.....	23
1. Frequently asked questions	10	Clock.....	24
What is the lock code?.....	10	Antenna locations.....	25
Where can I get settings for my device?.....	10	4. Personalise your device	26
How can I transfer content from my old device?.....	11	Profiles	26
2. Get started	12	Select ringing tones.....	26
Keys and parts.....	12	Change the display theme.....	26
Insert the SIM card and battery.....	13	5. E-mail and instant messaging	28
Charge the battery.....	15	Messaging key.....	28
Switch the device on or off.....	15	Ovi Mail.....	28
Lock the keys.....	16	Nokia Messaging.....	28
Connect the headset.....	16	Mail for Exchange.....	28
Memory cards.....	16	Chat.....	29
Shortcuts.....	17	6. Ovi Maps	30
3. Your Nokia 6760 slide	19	Positioning (GPS).....	30
Phone setup.....	19	About Maps.....	33
Settings wizard.....	19	Move on a map.....	34
Transfer content.....	19	Plan a route.....	34
Make calls.....	20	Navigate to the destination.....	34
Voice mail	20	7. Internet and connectivity	36

Internet key.....	36
Browser.....	36
Fast downloading.....	38
Connect the USB data cable.....	38
Bluetooth.....	39
Connection manager.....	42

8. Calendar and contacts.....43

Create a calendar entry.....	43
Calendar views.....	43
Save and edit names and numbers.....	43
Create contact groups.....	44
Add ringing tones for contacts.....	44

9. Images and music.....45

Camera.....	45
Gallery.....	45
Share online.....	46
About Ovi Share.....	47
Music player.....	47
FM radio.....	48
RealPlayer.....	48

10. Office applications.....50

Calculator.....	50
Convert measurements.....	50
Find and organise files.....	50
Quickoffice.....	51
Zip manager.....	51
PDF reader.....	51

11. Downloads.....52

Application manager.....	52
Download!.....	54

12. Protect your device and data.....56

Lock the device.....	56
Memory card security.....	56
Back up data.....	57
Be careful when you connect.....	57

13. Settings.....58

General settings.....	58
Phone settings.....	58
Connection settings.....	58
Application settings.....	59

14. Green tips.....60

Save energy.....	60
Recycle.....	60
Save paper.....	60
Learn more.....	60

Accessories.....61

Battery.....62

Battery and charger information.....	62
Nokia battery authentication guidelines.....	63

Taking care of your device.....64

Recycle.....	64
--------------	----

Contents

Additional safety information.....	65
Small children.....	65
Operating environment.....	65
Medical devices.....	65
Vehicles.....	66
Potentially explosive environments.....	66
Emergency calls.....	66
Certification information (SAR).....	67
Index.....	68

Safety

Read these simple guidelines. Not following them may be dangerous or illegal. Read the complete user guide for further information.



SWITCH ON SAFELY

Do not switch the device on when wireless phone use is prohibited or when it may cause interference or danger.



ROAD SAFETY COMES FIRST

Obey all local laws. Always keep your hands free to operate the vehicle while driving. Your first consideration while driving should be road safety.



INTERFERENCE

All wireless devices may be susceptible to interference, which could affect performance.



SWITCH OFF IN RESTRICTED AREAS

Follow any restrictions. Switch the device off in aircraft, near medical equipment, fuel, chemicals, or blasting areas.



QUALIFIED SERVICE

Only qualified personnel may install or repair this product.



ACCESSORIES AND BATTERIES

Use only approved accessories and batteries. Do not connect incompatible products.



WATER-RESISTANCE

Your device is not water-resistant. Keep it dry.

About your device

The wireless device described in this guide is approved for use on the (E)GSM 850/900/1800/1900 and UMTS 900/2100 HSDPA networks. Contact your service provider for more information about networks.

Your device supports several connectivity methods and like computers may be exposed to viruses and other harmful content. Exercise caution with messages, connectivity requests, browsing, and downloads. Only install and use services and software from trustworthy sources that offer adequate security and protection, such as applications that are Symbian Signed or have passed the Java Verified™ testing. Consider installing antivirus and other security software on your device and any connected computer.

Your device may have preinstalled bookmarks and links for third-party internet sites and may allow you to access third-party sites. These are not affiliated with Nokia, and Nokia does not endorse or assume liability for them. If you access such sites, take precautions for security or content.



Warning: To use any features in this device, other than the alarm clock, the device must be switched on. Do not

Safety

switch the device on when wireless device use may cause interference or danger.

When using this device, obey all laws and respect local customs, privacy and legitimate rights of others, including copyrights. Copyright protection may prevent some images, music, and other content from being copied, modified, or transferred.

Make back-up copies or keep a written record of all important information stored in your device.

When connecting to any other device, read its user guide for detailed safety instructions. Do not connect incompatible products.

The images in this guide may differ from your device display.

Refer to the user guide for other important information about your device.

Office applications

The office applications support common features of Microsoft Word, PowerPoint, and Excel (Microsoft Office 2000, XP, and 2003). Not all file formats are supported.

Network services

To use the device you must have service from a wireless service provider. Some features are not available on all networks; other features may require that you make specific arrangements with your service provider to use them.

Network services involve transmission of data. Check with your service provider for details about fees in your home

network and when roaming on other networks. Your service provider can explain what charges will apply. Some networks may have limitations that affect how you can use some features of this device requiring network support such as support for specific technologies like WAP 2.0 protocols (HTTP and SSL) that run on TCP/IP protocols and language-dependent characters.

Your service provider may have requested that certain features be disabled or not activated in your device. If so, these features will not appear on your device menu. Your device may also have customized items such as menu names, menu order, and icons.

Shared memory

The following features in this device may share memory: tones, graphics, contacts, text messages, multimedia messages, instant messages, e-mail, calendar, games, notes, and applications. Use of one or more of these features may reduce the memory available for the remaining features. If your device displays a message that the memory is full, delete some of the information stored in the shared memory.

Support

When you want to learn more about how to use your product or you are unsure how your device should function, see the support pages at www.nokia.com/support or your local Nokia website, www.nokia.mobi/support (with a mobile device), the Help application in the device, or the user guide.

If this does not resolve your issue, do the following:

- Restart the device: switch off the device, and remove the battery. After about a minute, replace the battery, and switch on the device.
- With the Nokia Software Updater application, update your device software regularly for optimum performance and possible new features. See www.nokia.com/softwareupdate or your local Nokia website. Remember to back up your device data before updating the device software.
- Restore the original factory settings as explained in the user guide. Your documents and files are not deleted in the reset.

If the issue remains unsolved, contact Nokia for repair options. See www.nokia.com/repair. Before sending your device for repair, always back up the data in your device.

1. Frequently asked questions

When you take a new device into use, you may have questions. In addition to those answered in this guide, visit the product support pages of the Nokia website.

What is the lock code?

Your device is equipped with one or more codes to protect the device itself or the SIM card against unauthorised use.

Lock code

The lock code (also known as security code) protects your device against unauthorised use. The preset code is 12345.

You can change the code, and set the device to request the code. [See "Lock the device", p. 56.](#)

You must remember the new code, and keep it secret and in a safe place separate from your device. If you forget the lock code and your device is locked, you must take the device to a Nokia authorised service facility and additional charges may apply. To unlock the device, the software must be reloaded, and the data you have saved in the device may be lost.

PIN and PUK codes

If you forget any of the following access codes, contact your service provider.

- Personal identification number (PIN) code — This code protects your SIM card against unauthorised use. The PIN

code (4-8 digits) is usually supplied with the SIM card. After three consecutive incorrect PIN code entries, the code is blocked, and you need the PUK code to unblock it.

- PIN2 code — This code (4-8 digits) is supplied with some SIM cards, and is required to access some functions in your device.
- Personal Unblocking Key (PUK) code and PUK2 code — These codes (8 digits) are required to change a blocked PIN code or PIN2 code, respectively. If the codes are not supplied with the SIM card, contact the operator whose SIM card is in your device.

Where can I get settings for my device?

Your device normally has MMS, GPRS, streaming, and mobile internet settings automatically configured, based on your network service provider information. You may have settings from your service providers already installed in your device, or you may receive or request the settings from the network service providers as a special message.

You can also use the Settings wizard application to define the settings. [See "Settings wizard", p. 19.](#)

How can I transfer content from my old device?

You can use the Nokia Switch application to copy content such as phone numbers, addresses, calendar items, and images from your previous Nokia device to your Nokia 6760 slide.

[See "Transfer content", p. 19.](#)

2. Get started

Model number: 6760s-1.

Keys and parts



1 — Power/End key

2 — Right selection key

3 — Navi™ key; hereafter referred as scroll key

4 — Call key

5 — Left selection key

6 — Quick access keys: internet, menu , and messaging keys

7 — Backspace key

8 — Sym (symbol) key

9 — Shift key

10 — Function key

11 — Camera

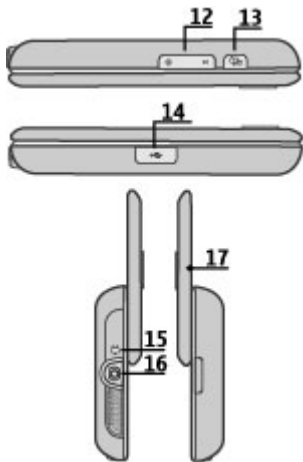

- 12 — Volume keys
- 13 — Capture key
- 14 — Micro USB connector
- 15 — Charger connector
- 16 — Headset connector
- 17 — Microphone

Insert the SIM card and battery

Safe removal. Always switch the device off and disconnect the charger before removing the battery.

1. Remove the back cover.



2. Remove the battery, if inserted.

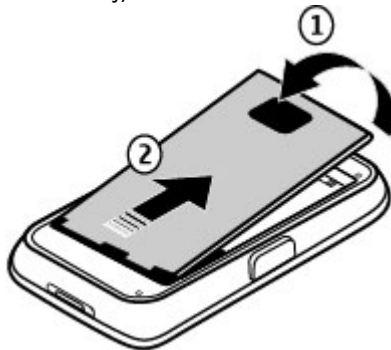

Get started

3. Insert the SIM card in the card holder. Ensure that the contact area on the card faces down. Close the SIM card holder, and slide the cover of the holder to lock it.



4. Align the battery contacts with the battery compartment connectors, and insert the battery.



5. Replace the back cover.

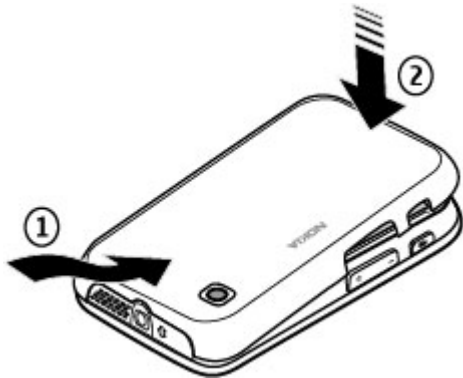

Charge the battery

Your battery has been partially charged at the factory. If the device indicates a low charge, do the following:

1. Connect the charger to a wall outlet.
2. Connect the charger to the device. The charging port is behind the black cover.



3. When the device indicates a full charge, disconnect the charger from the device, then from the wall outlet.

You do not need to charge the battery for a specific length of time, and you can use the device while it is charging. If the battery is completely discharged, it may take several minutes before the charging indicator appears on the display or before any calls can be made.



Tip: Disconnect the charger from the wall outlet when the charger is not in use. A charger that is connected to the outlet consumes power even when it is not connected to the device.

Switch the device on or off

Press and hold the power key until you feel the device vibrate.

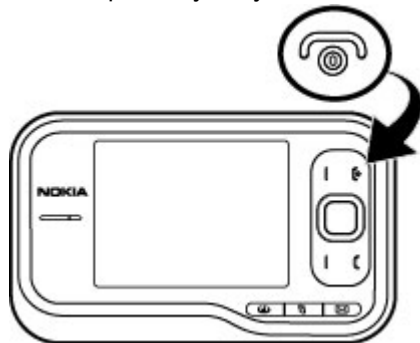

If prompted, enter the PIN code or lock code, and select **OK**. If the device asks for the lock code, enter the lock code, and select **OK**. See ["What is the lock code?"](#), p. 10.

The Phone setup application opens when you switch on your device for the first time. With the Phone setup application, you can customise how the device looks and works. To open the Phone setup application later, select  > **Applications** > **Help** > **Phone setup**.

To set the correct time zone, time, and date, select the country you are located and the current date and time. To find your country, enter the first letters of the country name. It is important to select the correct country, because scheduled calendar entries may change if you change the

Get started

country later and the new country is located in a different time zone.

Lock the keys

When the device or keypad is locked, calls may be possible to the official emergency number programmed into your device.

You can set the keypad to lock automatically after a time-out period, or when the slide is closed.

To change the length of the time-out period, after which the keypad is locked, select  > **Tools** > **Settings** and **General** > **Security** > **Phone and SIM card** > **Keypad autolock period** > **User defined** and the desired length of time.

To manually lock the keypad in phone mode, press the end key, and select **Lock keypad**.



Tip: When the keypad is locked, press and hold the scroll key to quickly view the date and time.

Connect the headset

Connect the compatible headset to the headset connector of your device.



Do not connect products that create an output signal as this may cause damage to the device. Do not connect any voltage source to the Nokia AV Connector.

When connecting any external device or any headset, other than those approved by Nokia for use with this device, to the Nokia AV Connector, pay special attention to volume levels.

Memory cards

Supported memory cards

Use only compatible microSD cards approved by Nokia for use with this device. Nokia uses approved industry standards for memory cards, but some brands may not be fully compatible with this device. Incompatible cards may damage the card and the device and corrupt data stored on the card.

Keep all memory cards out of the reach of small children.

You can extend the available memory with a microSDHC or microSD card with a capacity of up to 8 GB. Optimal performance is with a 4 GB microSD card. You can insert or remove a microSDHC or microSD card without switching the device off.

To maximize the performance of your device, it is recommended that no more than 100 files are stored in any folder.



Insert the memory card

Use a memory card to increase the amount of memory available for your device. You can also back up information from your device to the memory card.

Check the compatibility of a memory card with its manufacturer or provider.

A compatible memory card may be included in the sales package. The memory card may be already inserted in the device. If not, do the following:

1. Remove the back cover.
2. Insert the memory card in the slot with the contact area first. Ensure the contact area is facing the connectors on the device.



3. Push the card in until it locks into place.
4. Close the back cover.

Remove the memory card

1. Press the power key briefly, and select **Remove memory card**.
2. Remove the back cover.
3. Press the end of the memory card to release it from the memory card slot, and remove the card.
4. Replace the cover.

Shortcuts

Here are some of the keyboard shortcuts in your device. Shortcuts can make the use of the applications more efficient.

Get started

Shortcuts

General shortcuts

Power key	Press and hold to switch your device on and off. Press once to switch between profiles.
#	Press and hold # to activate the Silent profile.
Scroll key	Press and hold the scroll key to view the screen saver clock when the keypad is locked.

Standby mode

Call key	Open the call log. Up to 20 numbers that you last called or attempted to call are displayed. Scroll to the desired number or name, and press the call key.
0	Press and hold to open your homepage in the browser.
Number key (2-9)	Call a phone number using speed dialling. To activate speed dialling, select  > Tools > Settings and Phone > Call > Speed dialling .

Web shortcuts

Function key + *	Zoom in the page.
------------------	-------------------

Function key + #	Zoom out the page.
y	Go to the homepage.
r	Open the bookmarks folder.
t	Open the search dialog.
p	Return to the previous page.
w	View the active pages.
b	View the page overview.
n	Enter a new web address.

3. Your Nokia 6760 slide

After you have switched on your device, start to explore.

Phone setup

When you switch on your device for the first time, the Phone setup application opens.

To access the Phone setup application later, select  > **Applications** > **Help** > **Phone setup**.

To set up the device connections, select **Settings wizard**.

To transfer data to your device from a compatible Nokia device, select **Phone switch**.

The available options may vary.

Settings wizard

Select  > **Tools** > **Settings wizard**.

Use Settings wizard to define e-mail and connection settings. The availability of the items in Settings wizard depends on the features of the device, SIM card, service provider, and the data in the Settings wizard database.

To start Settings wizard, select **Start**.

To get the best results when using the settings wizard, keep your SIM card inserted in the device. If the SIM card is not inserted, follow the instructions on the display.

Select from the following:

- **Operator** — Define the operator-specific settings, such as MMS, internet, WAP, and streaming settings.
- **E-mail setup** — Configure a POP, IMAP, or Mail for Exchange account.

The settings available for editing may vary.

Transfer content

The type of content that can be transferred depends on the model of the device from which you want to transfer content. If that device supports synchronisation, you can also synchronise data between the devices. Your Nokia 6760 slide notifies you if the other device is not compatible.

If the other device cannot be switched on without a SIM card, you can insert your SIM card in it. When your Nokia 6760 slide is switched on without a SIM card, the offline profile is automatically activated, and transfer can be done.

Transfer content for the first time

1. To retrieve data from the other device for the first time, on your Nokia 6760 slide, select **Switch** in the Phone setup application, or select  > **Tools** > **Switch**.
2. Select the connection type you want to use to transfer the data. Both devices must support the selected connection type.
3. If you select Bluetooth, connect the two devices. To have your device search for devices with Bluetooth connectivity, select **Continue**. Select the device from

Your Nokia 6760 slide

which you want to transfer content. You are asked to enter a code on your Nokia 6760 slide. Enter a code (1-16 digits), and select **OK**. Enter the same code on the other device, and select **OK**. The devices are now paired.

Some earlier Nokia devices may not have the Switch application. In this case, the Switch application is sent to the other device as a message. To install Switch on the other device, open the message, and follow the instructions.

4. From your Nokia 6760 slide, select the content you want to transfer from the other device.

When the transfer has started, you can cancel it and continue later.

Content is transferred from the memory of the other device to the corresponding location in your Nokia 6760 slide. The length of the transfer time depends on the amount of data to be transferred.

Make calls



Note: The actual invoice for calls and services from your service provider may vary, depending on network features, rounding off for billing, taxes, and so forth.

To make and receive calls, the device must be switched on, it must have a valid SIM card installed, and you must be located in the service area of a cellular network.



Important: In the Offline profile you cannot make or receive any calls, or use other features that require cellular network coverage. Calls may still be possible to the official emergency number programmed into your device. To make calls, you must first activate the phone function by changing profiles. If the device has been locked, enter the lock code.

Make calls

To make a call, enter the phone number, including the area code, and press the call key. To end the call or cancel the call attempt, press the end key.



Tip: For international calls, add the + character that replaces the international access code, and enter the country code, area code (omit the leading 0, if necessary), and phone number.

Answer a call

To answer a call, press the call key. To reject a call, press the end key.

To mute the ringing tone instead of answering a call, select **Silence**.

To adjust the volume of an active call, use the volume keys.

Voice mail

Select  > **Tools** > **Call mailbox**.

When you open the Voice mail application for the first time, you are asked to enter the number of your voice mailbox.

To call your voice mailbox, scroll to Voice mailbox, and select **Options > Call voice mailbox**.

To call your mailbox in the standby mode, press and hold **1**; or press **1** and then the call key. Select the mailbox you want to call.

To change the mailbox number, select the mailbox and **Options > Change number**.

Volume control

To adjust the earpiece or loudspeaker volume during a call or when listening to an audio file, use the volume keys.

To activate or deactivate the loudspeaker during a call, select **Loudsp.** or **Handset**.



Warning: Continuous exposure to high volume may damage your hearing. Listen to music at a moderate level, and do not hold the device near your ear when the loudspeaker is in use.

Write text with the keyboard

Your device has a full keyboard.



To insert punctuation marks, press the corresponding key or a combination of keys.

To switch between the character cases, press the shift key.

To insert characters printed at the top of keys, press and hold the function key and press the corresponding key.

To erase a character, press the backspace key. To erase several characters, press and hold the backspace key.

To insert characters and symbols that are not shown on the keyboard, press the sym key.

Your Nokia 6760 slide

To change the writing language, or to activate predictive text input, select **Options** > **Input options** and the appropriate option.

Write and send messages

Select  > **Messaging**.



Important: Exercise caution when opening messages. Messages may contain malicious software or otherwise be harmful to your device or PC.

Before you can create a multimedia message or write an e-mail, you must have the correct connection settings in place.

The wireless network may limit the size of MMS messages. If the inserted picture exceeds this limit, the device may make it smaller so that it can be sent by MMS.

Check the size limit of e-mail messages with your service provider. If you attempt to send an e-mail message that exceeds the size limit of the e-mail server, the message is left in the Outbox folder, and the device attempts to resend it periodically. Sending an e-mail requires a data connection, and continuous attempts to resend the e-mail may increase your phone bill. In the Outbox folder, you can delete such a message, or move it to the Drafts folder.

1. Select **New message** > **Message** to send a text or multimedia message (MMS), **Audio message** to send a multimedia message that includes one sound clip, or **E-mail** to send an e-mail message.

2. In the To field, press the scroll key to select recipients or groups from the contacts list, or enter the recipient's phone number or e-mail address. To add a semicolon (;) that separates the recipients, press *. You can also copy and paste the number or address from the clipboard.
3. In the subject field, enter the subject of the e-mail. To change the fields that are visible, select **Options** > **Message header fields**.
4. In the message field, write the message. To insert a template or note, select **Options** > **Insert content** > **Insert text** > **Template** or **Note**.
5. To add a media file to a multimedia message, select **Options** > **Insert content**, the file type or source, and the desired file. To insert a business card, slide, note, or some other file to the message, select **Options** > **Insert content** > **Insert other**.
6. To capture an image or record a video or sound clip for a multimedia message, select **Options** > **Insert content** > **Insert image** > **New, Insert video clip** > **New**, or **Insert sound clip** > **New**.
7. To add an attachment to an e-mail, select **Options** and the attachment type. E-mail attachments are indicated by .
8. To send the message, select **Options** > **Send**, or press the call key.



Note: The message sent icon or text on your device screen does not indicate that the message is received at the intended destination.

Your device supports text messages beyond the limit for a single message. Longer messages are sent as two or more messages. Your service provider may charge accordingly. Characters with accents, other marks, or some language options take more space, and limit the number of characters that can be sent in a single message.

You may not be able to send video clips that are saved in the MP4 file format or that exceed the size limit of the wireless network in a multimedia message.

Active standby

When you have switched on the device, and it is registered to a network, the device is in the standby mode and ready for use.

To open the list of last dialled numbers, press the call key. Scroll left to access a list of received and missed calls.

To use voice commands or voice dialling, press and hold the right selection key.

To change the profile, press the power key, and select a profile.

To connect to the web, press the internet key.

Menu

The main menu is a starting point from which you can open all applications in the device or on a memory card. To access the main menu, press .

To open an application or a folder, select the item.

To change the menu view, select  > **Options** > **Change Menu view** and a view type.

To close an application or a folder, select **Back** and **Exit** as many times as needed to return to the standby mode.





Tip: To display and switch between open applications, press and hold the menu key, and select an application. To close an application, press the backspace key.

Leaving applications running in the background increases the demand of battery power and reduces the battery life.

Indicators

 The device is connected to a UMTS or GSM network.

 The battery charge level. The higher the bar, the stronger the charge in the battery.

 You have one or more unread messages in the Inbox folder in Messaging.

 You have received new e-mail in the remote mailbox.

 There are messages waiting to be sent in the Outbox folder in Messaging.

 You have one or more missed phone calls.

 The keys of the device are locked.



 An alarm is active.



 You have activated the Silent profile, and the device does not ring for an incoming call or message.



 Bluetooth connectivity is activated.



Your Nokia 6760 slide

 A Bluetooth connection is established. When the indicator is blinking, your device is trying to connect with another device.

 A GPRS packet data connection is available (network service).  indicates that the connection is active.  indicates that the connection is on hold.

 An EGPRS packet data connection is available (network service).  indicates that the connection is active.  indicates that the connection is on hold.

 A UMTS packet data connection is available (network service).  indicates that the connection is active.  indicates that the connection is on hold.

 High-speed downlink packet access (HSDPA) is supported and available (network service). The icon may vary between regions.  indicates that the connection is active.  indicates that the connection is on hold.

 Your device is connected to a computer with a USB data cable.

2 The second phone line is being used (network service).

 All calls are forwarded to another number. If you have two phone lines, a number indicates the active line.

 A headset is connected to the device.

 A handsfree car kit is connected to the device.

 A loopset is connected to the device.

 A text phone is connected to the device.

 Your device is synchronising.

Clock

With Clock, you can view your local time or time in other cities, and use your device as an alarm clock.

Alarm clock

Select  > **Applications** > **Clock**.

To view your active and inactive alarms, open the alarms tab. To set a new alarm, select **Options** > **New alarm**. Define the repetition, if needed. When an alarm is active,  is displayed.

To turn off the sounding alarm, select **Stop**. To stop the alarm for a certain time period, select **Snooze**. If your device is switched off when an alarm is due, your device switches itself on and starts sounding the alarm tone.

 **Tip:** To define the time period after which the alarm sounds again when you set it to snooze, select **Options** > **Settings** > **Alarm snooze time**.

To cancel an alarm, select **Options** > **Remove alarm**.

To change the time, date, and clock type settings, select **Options** > **Settings**.

To automatically update the time, date, and time zone information to your device (network service), select **Options** > **Settings** > **Automatic time update** > **On**.

World clock

Select  > **Applications** > **Clock**.

To view the time in different locations, open the world clock tab. To add locations to the list, select **Options > Add location**. You can add a maximum of 15 locations to the list.

To set your current location, scroll to a location, and select **Options > Set as current location**. The location is displayed in the clock main view, and the time in your device is changed according to the selected location. Ensure that the time is correct and matches your time zone.

Clock settings

Select **Options > Settings**.

To change the time or date, select **Time** or **Date**.

To change the clock shown in the standby modes, select **Clock type > Analogue** or **Digital**.

To allow the mobile phone network to update the time, date, and time zone information to your device (network service), select **Automatic time update > On**.

To change the alarm tone, select **Clock alarm tone**.

Antenna locations

Your device has three integrated antennas: cellular antenna, Bluetooth antenna, and GPS antenna.

Your device may have internal and external antennas. Avoid touching the antenna area unnecessarily while the antenna is transmitting or receiving. Contact with antennas affects the communication quality and may cause a higher power level during operation and may reduce the battery life.

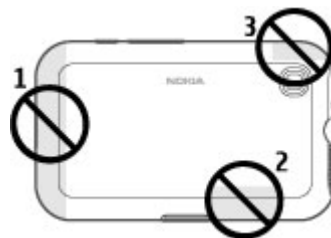

- 1 — Cellular antenna
- 2 — Bluetooth antenna
- 3 — GPS antenna

4. Personalise your device

You can personalise your device by, for example, adjusting the various tones, and changing the background image and screen saver.

Profiles

Select  > **Tools** > **Profiles**.

You can adjust and customise the ringing tones, alert tones, and other device tones for different events, environments, or caller groups. The active profile is shown at the top of the display in the standby mode. However, if the active profile is General, only today's date is shown.

To create a new profile, select **Options** > **Create new**, and define the settings.

To customise a profile, select a profile and **Options** > **Personalise**.

To change a profile, select a profile and **Options** > **Activate**. The Offline profile prevents your device from accidentally switching on, sending or receiving messages, or using Bluetooth connectivity, GPS, or FM radio; it also closes any internet connection that may be in operation when the profile is selected. The Offline profile does not prevent you from establishing a Bluetooth connection at a later time, or from restarting the GPS or FM radio, so comply with any applicable safety requirements when establishing and using these features.

To set the profile to be active until a certain time within the next 24 hours, scroll to the profile, select **Options** > **Timed**, and set the time. When the time expires, the profile changes back to the previously active non-timed profile. When the profile is timed,  is displayed in the standby mode. The Offline profile cannot be timed.

To delete a profile that you created, select **Options** > **Delete profile**. You cannot delete the predefined profiles.

Select ringing tones

To set a ringing tone for a profile, select **Options** > **Personalise** > **Ringtone**. Select a ringing tone from the list, or select **Download sounds** to open a bookmark folder containing a list of bookmarks for downloading tones using the browser. Any downloaded tones are saved to Gallery.

To play the ringing tone for a selected contact group only, select **Options** > **Personalise** > **Alert for**, and select the desired group. Phone calls coming from outside that group have a silent alert.

To change the message tone, select **Options** > **Personalise** > **Message alert tone**.

Change the display theme

Select  > **Tools** > **Themes**.

To change the theme used in all applications, select **General**.

To change the theme used in the main menu, select **Menu view**.

To change the theme for a particular application, select the application-specific folder.

To change the background image of the home screen, select **Wallpaper**.

To select an animation for the screen saver, select **Power saver**.

To turn theme effects on or off, select **General > Options > Theme effects**.

5. E-mail and instant messaging

With your device, you can read and reply to both personal and work e-mail, and chat with your instant messaging contacts.

Messaging key

Your device has a key for quick access to your messages.

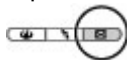

Ovi Mail

If you do not yet have an e-mail account, or want to create another one, Ovi Mail offers you that possibility. Ovi Mail is a free e-mail service that you can use from the web or directly from your device.

For more information, see mail.ovi.com.

This service may not be available in all regions or languages.

Nokia Messaging

With Nokia Messaging, you can receive e-mail sent to your personal e-mail address on your device.

You can access up to 10 personal e-mail accounts, such as Windows Live Hotmail or Google e-mail services. Each e-mail arrives in its own mailbox, and you can access all e-mails in one place.

Nokia Messaging can be used on your device together with most other e-mail solutions. However, if you are using Nokia

Intellisync Mobile Suite, you must uninstall it before using Nokia Messaging.

Nokia Messaging is currently provided on a trial basis.

Using Nokia Messaging may involve the transmission of large amounts of data (network service).

For more information, see www.email.nokia.com.

Mail for Exchange

With Mail for Exchange, you can receive your work e-mail to your device. You can read and reply to your e-mails, view and edit compatible attachments, view calendar information, receive and reply to meeting requests, schedule meetings, and view, add, and edit contact information. Mail for Exchange can be set up only if your company has Microsoft Exchange Server. In addition, your company's IT administrator must have activated Mail for Exchange for your account.

Before starting to set up Mail for Exchange, ensure that you have the following:

- A corporate e-mail ID
- Your office network user name
- Your office network password
- Your network domain name (contact your company's IT department)

- Your Mail for Exchange server name (contact your company's IT department)

Depending on your company's Mail for Exchange server configuration, you may need to enter other information in addition to those listed. If you do not know the correct information, contact your company's IT department.

With Mail for Exchange, the use of the lock code may be mandatory. The default lock code of your device is 12345, but your company's IT administrator may have set a different one for you to use.

You can access and modify the Mail for Exchange profile and settings in the Messaging settings.

Chat

With the instant messaging (IM) network service, you can send short, simple text messages to online users. You have to subscribe to a service and register with the IM service you want to use.

Select  > **Contacts**, and open the Ovi tab.

To connect to the service, select **Go online** and the connection method. A packet data connection may generate additional data transmission charges. For pricing details, contact your network service provider.

To start a chat with a friend, select **Options** > **Chat**. To send a chat message, enter the text in the message field, and select **Send**.

In the chat view, select **Options** and from the following:

- **Send** — Send the message.

- **Add smiley** — Insert a smiley.
- **Send my location** — Send your location details to your chat partner (if supported by both devices).
- **Profile** — View the details of a friend.
- **My profile** — Select your presence status or profile image, personalise your message, or modify your details.
- **Edit text** — Copy or paste text.
- **End chat** — End the active chat.
- **Exit** — End all active chats, and close the application.

The available options may vary.

To receive location information from your friend, you must have the Maps application. To send and receive location information, both the Maps and Positioning applications are needed.

To view the location of your friend, select **Show on map**.

To return to the Ovi Contacts main view without ending the chat, select **Back**. If you select a phone number in a chat, to add it to your contacts list, call, or copy the number, select **Options** and the appropriate option.

6. Ovi Maps

Need directions? Looking for a restaurant? Your device has the tools to get you where you want to be.

Positioning (GPS)

You can use applications such as GPS data to determine your location, or measure distances and coordinates. These applications require a GPS connection.

About GPS

The coordinates in the GPS are expressed in the degrees and decimal degrees format using the international WGS-84 coordinate system. The availability of the coordinates may vary by region.

The Global Positioning System (GPS) is operated by the government of the United States, which is solely responsible for its accuracy and maintenance. The accuracy of location data can be affected by adjustments to GPS satellites made by the United States government and is subject to change with the United States Department of Defense civil GPS policy and the Federal Radionavigation Plan. Accuracy can also be affected by poor satellite geometry. Availability and quality of GPS signals may be affected by your location, buildings, natural obstacles, and weather conditions. GPS signals may not be available inside buildings or underground and may be impaired by materials such as concrete and metal.

GPS should not be used for precise location measurement, and you should never rely solely on location data from the

GPS receiver and cellular radio networks for positioning or navigation.

The trip meter has limited accuracy, and rounding errors may occur. Accuracy can also be affected by availability and quality of GPS signals.

Different positioning methods can be enabled or disabled in positioning settings.

Assisted GPS (A-GPS)

Your device also supports assisted GPS (A-GPS).

A-GPS requires network support.

Assisted GPS (A-GPS) is used to retrieve assistance data over a packet data connection, which assists in calculating the coordinates of your current location when your device is receiving signals from satellites.

When you activate A-GPS, your device receives useful satellite information from an assistance data server over the cellular network. With the help of assisted data, your device can obtain the GPS position faster.

Your device is preconfigured to use the Nokia A-GPS service, if no service provider-specific A-GPS settings are available. The assistance data is retrieved from the Nokia A-GPS service server only when needed.

To disable the A-GPS service, select  > **Applications** > **GPS data and Options** > **Positioning settings** > **Positioning methods** > **Assisted GPS** > **Disable**.

You must have an internet access point defined in the device to retrieve assistance data from the Nokia A-GPS service over a packet data connection. The access point for A-GPS can be defined in positioning settings. Only a packet data internet access point can be used. Your device asks you to select the internet access point when GPS is used for the first time.

Hold your device correctly

When using the GPS receiver, ensure you do not cover the antenna with your hand.

Establishing a GPS connection may take from a couple of seconds to several minutes. Establishing a GPS connection in a vehicle may take longer.

The GPS receiver draws its power from the device battery. Using the GPS receiver may drain the battery faster.



Tips on creating a GPS connection

Check satellite signal status

To check how many satellites your device has found, and whether your device is receiving satellite signals, select **Applications** and **GPS data** > **Position** > **Options** > **Satellite status**.

If your device has found satellites, a bar for each satellite is shown in the satellite info view. The longer the bar, the stronger the satellite signal. When your device has received enough data from the satellite signal to calculate the coordinates of your location, the bar turns blue.



To view the positions of found satellites, select **Chg. view**.

Initially your device must receive signals from at least four satellites to be able to calculate the coordinates of your location. When the initial calculation has been made, it may be possible to continue calculating the coordinates of your location with three satellites. However, the accuracy is generally better when more satellites are found.

If your device cannot find the satellite signal, consider the following:

- If you are indoors, go outdoors to receive a better signal.
- If you are outdoors, move to a more open space.
- Ensure that your hand does not cover the GPS antenna of your device.
- If the weather conditions are bad, the signal strength may be affected.
- Some vehicles have tinted (athermic) windows, which may block the satellite signals.

Position requests

You may receive a request from a network service to receive your position information. Service providers may offer information about local topics, such as weather or traffic conditions, based on the location of your device.

When you receive a position request, the service that is making the request is displayed. Select **Accept** to allow your position information to be sent or **Reject** to deny the request.

Landmarks

Select  > **Applications** > **Landmarks**.

With Landmarks, you can save the position information of specific locations in your device. You can sort the saved locations into different categories, such as business, and add other information to them, such as addresses. You can use your saved landmarks in compatible applications, such as GPS data.

GPS coordinates are expressed in the degrees and decimal degrees format using the international WGS-84 coordinate system.

Select **Options** and from the following:

- **New landmark** — Create a new landmark. To make a positioning request for your current location, select **Current position**. To select the location from map, select **Select from map**. To enter the position information manually, select **Enter manually**.
- **Edit** — Edit or add information to a saved landmark (for example, a street address).

- **Add to category** — Add a landmark to a category in Landmarks. Select each category to which you want to add the landmark.
- **Send** — Send one or several landmarks to a compatible device. Your received landmarks are placed in the Inbox folder in Messaging.

You can sort your landmarks into preset categories, and create new categories. To edit and create new landmark categories, open the categories tab, and select **Options** > **Edit categories**.

GPS data

Select  > **Applications** > **GPS data**.

GPS data is designed to provide route guidance information to a selected destination, position information about your current location, and travelling information, such as the approximate distance to the destination and the approximate duration of travel.

The coordinates in the GPS are expressed in degrees and decimal degrees format using the international WGS-84 coordinate system.

To use GPS data, the GPS receiver of your device must initially receive position information from at least four satellites to calculate the coordinates of your location. When the initial calculation has been made, it may be possible to continue calculating the coordinates of your location with three satellites. However, the accuracy is generally better when more satellites are found.

Route guidance

Select  > **Applications** > **GPS data** and **Navigation**.

Start the route guidance outdoors. If started indoors, the GPS receiver may not receive the necessary information from the satellites.

Route guidance uses a rotating compass on the device display. A red ball shows the direction to the destination, and the approximate distance to it is shown inside the compass ring.

Route guidance is designed to show the straightest route and the shortest distance to the destination, measured in a straight line. Any obstacles on the route, such as buildings and natural obstacles, are ignored. Differences in altitude are not taken into account when calculating the distance. Route guidance is active only when you move.

To set your trip destination, select **Options** > **Set destination** and a landmark as the destination, or enter the latitude and longitude coordinates.

To clear the destination set for your trip, select **Stop navigation**.

Retrieve position information

Select  > **Applications** > **GPS data** and **Position**.

In the position view, you can view the position information of your current location. An estimate of the accuracy of the location is displayed.

To save your current location as a landmark, select **Options** > **Save position**. Landmarks are saved locations with more

information, and they can be used in other compatible applications and transferred between compatible devices.

Trip meter

Select  > **Applications** > **GPS data** and **Trip distance**.

The trip meter has limited accuracy, and rounding errors may occur. Accuracy can also be affected by availability and quality of GPS signals.

To turn trip distance calculation on or off, select **Options** > **Start** or **Stop**. The calculated values remain on the display. Use this feature outdoors to receive a better GPS signal.

To set the trip distance and time and average and maximum speeds to zero, and to start a new calculation, select **Options** > **Reset**. To set the trip meter and total time to zero, select **Restart**.

About Maps

With Maps, you can see your current location on the map, browse maps of different cities and countries, search for places, plan routes from one location to another, save locations, and send them to compatible devices. You can also purchase licences for traffic information and navigation services, if available for your country or region.

When you use Maps for the first time, you may need to select an internet access point for downloading maps.

If you browse to an area which is not covered by maps already downloaded in your device, a map for the area is automatically downloaded through the internet. Some maps

Ovi Maps

may be available in your device or on a memory card. You can also use the Nokia Map Loader PC software to download maps. To install Nokia Map Loader to a compatible PC, see www.nokia.com/maps.



Tip: To avoid data transfer costs, you can also use Maps without an internet connection, and browse the maps that are saved in your device or memory card.



Note: Downloading content such as maps, satellite images, voice files, guides or traffic information may involve transmission of large amounts of data (network service). Almost all digital cartography is inaccurate and incomplete to some extent. Never rely solely on the cartography that you download for use in this device.

Move on a map

When the GPS connection is active,  shows your current location on the map.

To view your current or last known location, select **Options > My position**.

To move on the map, scroll up, down, left, or right with the scroll key. The map is oriented towards north by default.

When you have an active data connection and browse the map on the display, a new map is automatically downloaded if you scroll to an area not covered by the maps that have already been downloaded. The maps are automatically saved in the device memory or on a compatible memory card, if inserted.

To zoom in and out on the map, press the left and right shift keys, or the shift key and the backspace key, depending on the keyboard of your device.

To change the map type, select **Options > Map mode**.

Plan a route

To plan a route, scroll to your start point on the map, press the scroll key, and select **Add to route**. To add the destination and more locations to the route, select **Add new route point**. If you want to use your current position as the starting point, add the destination to the route.

To change the order of the locations in the route, scroll to a location, press the scroll key, and select **Move**. Scroll to the place where you want to move the location, and select **Select**.

To edit the route, press the scroll key, and select **Edit route**.

To show the route on the map, select **Show route**.

To navigate to the destination by car or on foot, if you have purchased a licence for these services, select **Show route > Options > Start driving** or **Start walking**.

To save the route, select **Show route > Options > Save route**.

Navigate to the destination

To navigate to your destination, you must purchase a licence for the navigation service.

To purchase a licence for pedestrian and car navigation, select **Options** > **Shop & Licenses** > **Drive & Walk**. To purchase a licence for pedestrian navigation only, select **Walk**. The licence is region-specific and can be used only in the selected area. You can pay for the licence through a credit card or in your phone bill, if supported by your service provider. You can transfer the licence from your device to another compatible device, but the licence can only be used in one device at a time.

When you use car navigation for the first time, you are asked to select the language of the voice guidance and download the related voice guidance files. To change the language later, in the main view, select **Options** > **Tools** > **Settings** > **Navigation** > **Voice guidance**. Voice guidance is not available for pedestrian navigation.

To start navigating, scroll to a location, press the scroll key, and select **Drive to** or **Walk to**.

To stop navigating, select **Stop**.

7. Internet and connectivity

You can browse the internet, or connect your device to a compatible computer, using the various connectivity methods of your device.

Internet key

Your device has a key for accessing the web quickly.



Browser

With the Browser application, you can view web pages on the internet. You can also browse web pages that are designed specifically for mobile devices.

To browse the web, you need to have an internet access point configured in your device.

Browse the web

Select  > **Web**.



Shortcut: To open the browser, press the internet key.



Important: Use only services that you trust and that offer adequate security and protection against harmful software.



Important: Only install and use applications and other software from trusted sources, such as applications that are Symbian Signed or have passed the Java Verified™ testing.

The homepage opens. To change the homepage, select **Options** > **Settings**.

To browse a web page, in the bookmarks view, select a bookmark, or enter the address in the field () and press the scroll key.

Some web pages may contain material, such as graphics and sounds, that require a large amount of memory to view. If your device runs out of memory while loading such a web page, the graphics on the page are not displayed.

To browse web pages without graphics, to save memory, select **Options** > **Settings** > **Page** > **Load content** > **Text only**.

To enter a new web address, select **Options** > **Go to web address**.



Tip: While browsing, to open a bookmark, press **1**, and select a bookmark.

To refresh the content of the web page, select **Options** > **Navigation options** > **Reload**.

To save the current web page as a bookmark, select **Options** > **Save as bookmark**.

To view snapshots of the web pages you have visited during the current browsing session, select **Back** (available if **History list** is activated in the browser settings and the current web page is not the first web page you visit). Select the web page to return to.

To save a web page while browsing, select **Options** > **Tools** > **Save page**.

You can save web pages and browse them later when offline. You can also group web pages into folders. To access the web pages you have saved, in the bookmarks view, select **Saved pages**.

To open a sublist of commands or actions for the current web page, select **Options** > **Service options** (if supported by the web page).



To prevent or allow the automatic opening of multiple windows, select **Options** > **Window** > **Block pop-ups** or **Allow pop-ups**.

Shortcuts while browsing

- Press **1** to open the bookmarks view.
- Press **2** to search for keywords on the current page.
- Press **3** to return to the previous page.
- Press **5** to list all open windows.
- Press **8** to show the page overview of the current page. Press **8** again to zoom in and view the desired section of the page.
- Press **9** to enter a new web address.
- Press **0** to go to the homepage (if defined in settings).

- Press ***** and **#** to zoom in or out on the page.



Tip: To return to the home screen with the browser open in the background, press  twice or the end key. To return to the browser, press and hold , and select the browser.

Web feeds and blogs

Web feeds are XML files on web pages that are used to share, for example, the latest news headlines or blogs. Blogs or weblogs are web diaries. It is common to find web feeds on web, blog, and wiki pages.

The Web application automatically detects if a web page contains web feeds.

To subscribe to a web feed, select a feed and **Options** > **Subscribe to web feeds**.

To update a web feed, select a feed and **Options** > **Refresh**.

To define how the web feeds are updated, select **Options** > **Settings** > **Web feeds**.

Empty the cache

The information or services you have accessed are stored in the cache memory of the device.

A cache is a memory location that is used to store data temporarily. If you have tried to access or have accessed confidential information requiring passwords, empty the cache after each use. The information or services you have accessed are stored in the cache.

Internet and connectivity

To empty the cache, select **Options** > **Clear privacy data** > **Cache**.

End the connection

To end the connection and view the browser page offline, select **Options** > **Tools** > **Disconnect**; or to end the connection and close the browser, select **Options** > **Exit**.

To take the browser to the background, press the end key once. To end the connection, press and hold the end key.

To delete the information the network server collects about your visits to various web pages, select **Options** > **Clear privacy data** > **Cookies**.



Connection security

If the security indicator () is displayed during a connection, the data transmission between the device and the internet gateway or server is encrypted.

The security icon does not indicate that the data transmission between the gateway and the content server (where the data is stored) is secure. The service provider secures the data transmission between the gateway and the content server.

Security certificates may be required for some services, such as banking services. You are notified if the identity of the server is not authentic or if you do not have the correct security certificate in your device. For more information, contact your service provider.

Fast downloading

High-speed download packet access (HSDPA, also called 3.5G, indicated by ) is a network service in UMTS networks and provides high-speed data downloads. When HSDPA support in the device is activated and the device is connected to a UMTS network that supports HSDPA, downloading data such as messages, e-mail, and browser pages through the cellular network may be faster. An active HSDPA connection is indicated by . The icon may vary between regions.

To turn HSDPA on or off, select  > **Tools** > **Settings** and **Connection** > **Packet data** > **High speed packet access**. Some cellular networks do not allow incoming voice calls when HSDPA is active, in which case you need to deactivate HSDPA to receive calls. For more information, contact your service provider.

For availability and subscription to data connection services, contact your service provider.

HSDPA only affects the download speed; sending data to the network, such as messages and e-mail, is not affected.

Connect the USB data cable

The USB connector is behind a cover.

The USB data cable is for data transfer only and does not support charging.





To avoid corrupting data, do not disconnect the USB data cable during data transfer.

Transfer data between your device and a PC

1. Insert a memory card in your device, and connect the device to a compatible PC with the data cable.
2. When the device asks which mode to use, select **Mass storage**. In this mode, you can see your device as a removable hard drive in your computer.
3. End the connection from the computer (from the Unplug or Eject Hardware wizard in Microsoft Windows, for example) to avoid damaging the memory card.

To use Nokia PC Suite with your device, install Nokia PC Suite on your PC, connect the data cable, and select **PC Suite**.

To change the USB mode you normally use with the data cable, select  > **Tools** > **Settings** > **Connectivity** > **USB** and **USB connection mode**, and the desired option.

To set the device to ask for the mode each time you connect the data cable to the device, select  > **Tools** > **Settings** > **Connectivity** > **USB** and **Ask on connection** > **Yes**.

Bluetooth

Select  > **Tools** > **Connectivity** > **Bluetooth**.

About Bluetooth

Bluetooth technology in your device enables wireless connections between electronic devices within a range of 10 metres (33 feet). A Bluetooth connection can be used to send images, videos, text, business cards, calendar notes, or to connect wirelessly to devices that use Bluetooth technology.

Since devices using Bluetooth technology communicate using radio waves, your device and the other devices do not need to be in direct line-of-sight. The two devices only need to be within a maximum of 10 metres of each other, although the connection can be subject to interference from obstructions such as walls or other electronic devices.

Several Bluetooth connections can be active at a time. For example, if your device is connected to a headset, you can also transfer files to another compatible device at the same time.

This device is compliant with Bluetooth Specification 2.0 + EDR supporting the following profiles: advanced audio distribution, audio/video remote control, basic imaging, device identification, dial-up networking, file transfer, generic audio/video distribution, generic object exchange,

Internet and connectivity

hands-free, headset, human interface device, object push, phone book access, and SIM access. To ensure interoperability between other devices supporting Bluetooth technology, use Nokia approved accessories for this model. Check with the manufacturers of other devices to determine their compatibility with this device.

Features using Bluetooth technology increase the demand on battery power and reduce the battery life.

Send and receive data with Bluetooth

Select  > **Tools** > **Connectivity** > **Bluetooth**.

1. When you activate Bluetooth connectivity for the first time, you are asked to name your device. Give your device a unique name to make it easy to recognise if there are several Bluetooth devices nearby.
2. Select **Bluetooth** > **On**.
3. Select **My phone's visibility** > **Shown to all** or **Define period**. If you select **Define period**, you need to define the time during which your device is visible to others. Your device and the name you entered can now be seen by other users with devices using Bluetooth technology.
4. Open the application where the item you want to send is stored.
5. Select the item and **Options** > **Send** > **Via Bluetooth**. The device searches for other devices using Bluetooth technology within range and lists them.



Tip: If you have sent data using Bluetooth connectivity before, a list of the previous search

results is displayed. To search for more Bluetooth devices, select **More devices**.

6. Select the device with which you want to connect. If the other device requires pairing before data can be transmitted, you are asked to enter a passcode.

When the connection has been established, **Sending data** is displayed.

The Sent folder in the Messaging application does not store messages sent using Bluetooth connectivity.

To receive data using Bluetooth connectivity, select **Bluetooth** > **On** and **My phone's visibility** > **Shown to all** to receive data from a non-paired device or **Hidden** to receive data from a paired device only. When you receive data through Bluetooth connectivity, depending on the settings of an active profile, a tone sounds, and you are asked if you want to accept the message in which the data is included. If you accept, the message is placed in the Inbox folder in the Messaging application.



Tip: You can access the files in the device or on the memory card using a compatible accessory that supports the File Transfer Profile Client service (for example, a laptop computer).

A Bluetooth connection is disconnected automatically after sending or receiving data. Only Nokia PC Suite and some accessories such as headsets may maintain a connection even if not actively used.

Pair devices

Select  > **Tools** > **Connectivity** > **Bluetooth**.

Open the paired devices tab.

Before pairing, decide on your own passcode (1-16 digits), and agree with the user of the other device to use the same code. Devices that do not have a user interface have a fixed passcode. You need the passcode only when you connect the devices for the first time. After pairing, it is possible to authorise the connection. Pairing and authorising the connection makes connecting quicker and easier, as you do not have to accept the connection between paired devices every time you establish a connection.

The passcode for remote SIM access must have 16 digits.

When the wireless device is in the remote SIM mode, you can only use a compatible connected accessory, such as a car kit, to make or receive calls.

Your wireless device will not make any calls, except to the emergency numbers programmed into your device, while in this mode.

To make calls, you must first leave the remote SIM mode. If the device has been locked, enter the lock code to unlock it first.

1. Select **Options** > **New paired device**. The device starts to search for Bluetooth devices within range. If you have sent data using Bluetooth connectivity before, a list of the previous search results is displayed. To search for more Bluetooth devices, select **More devices**.
2. Select the device with which you want to pair, and enter the passcode. The same passcode must be entered to the other device as well.

3. Select **Yes** to make the connection between your device and the other device automatic, or **No** to confirm the connection manually every time a connection attempt is made. After pairing, the device is saved to the paired devices page.

To give a nickname to the paired device, select **Options** > **Assign short name**. The nickname is displayed in your device.

To delete a pairing, select the device whose pairing you want to delete and **Options** > **Delete**. To delete all pairings, select **Options** > **Delete all**. If you are currently connected to a device and cancel the pairing with that device, pairing is removed immediately, and the connection is ended.

To allow a paired device to connect automatically to your device, select **Set as authorised**. Connections between your device and the other device can be made without your knowledge. No separate acceptance or authorisation is needed. Use this status only for your own devices, such as your compatible headset or computer, or devices that belong to someone you trust. If you want to accept connection requests from the other device separately every time, select **Set as unauthorised**.

To use a Bluetooth audio accessory such as a Bluetooth handsfree or headset, you need to pair your device with the accessory. For the passcode and further instructions, see the accessory user guide. To connect to the audio accessory, switch on the accessory. Some audio accessories connect automatically to your device. Otherwise, open the paired devices tab, select the accessory and **Options** > **Connect to audio device**.

Connection manager

Select  > **Tools** > **Connectivity** > **Conn. mgr.**.

View and end active connections

Select  > **Tools** > **Connectivity** > **Conn. mgr.**.

To view detailed information about network connections, select a connection from the list and **Options** > **Details**. The type of information shown depends on the connection type.

To end the selected network connection, select **Options** > **Disconnect**.

To end all active network connections simultaneously, select **Options** > **Disconnect all**.

8. Calendar and contacts

With Calendar, you can, for example, keep track of your schedule, your friends' birthdays, or tasks that you need to do. Select  > **Office** > **Calendar**.

With Contacts, you can save and update contact information, such as phone numbers, home addresses, or e-mail addresses of your contacts. You can add a personal ringing tone or an image to a contact card. You can also create contact groups, which allow you to send text or e-mail messages to many recipients at the same time. Select  > **Contacts**.

You can use the Switch application to copy contacts from your previous Nokia device to your Nokia 6760 slide. [See "Transfer content", p. 19.](#)

Create a calendar entry

1. To add a new calendar entry, scroll to the desired date, select **Options** > **New entry** and from the following:
 - **Meeting** — Add a reminder of your meeting.
 - **Meeting request** — Create and send a new meeting request. You must have a mailbox set up for sending requests.
 - **Memo** — Write a general note for the day.
 - **Anniversary** — Add a reminder of birthdays or special dates (entries are repeated annually).
 - **To-do** — Add a reminder of a task that must be done by a specific date.
2. To add a description to an entry, select **Options** > **Add description**.

3. To save the entry, select **Done**.



Tip: In the day, week, or month calendar view, press a key (0-9). An appointment entry opens, and the characters you enter are added to the subject field. In the to-do view, a to-do note entry opens.

When the calendar alarm sounds, select **Silence** to mute the alarm.

To stop the calendar alarm, select **Stop**.

To set the alarm to snooze, select **Snooze**.

To define the period after which the calendar alarm sounds again when set to snooze, select **Options** > **Settings** > **Alarm snooze time**.

Calendar views

To switch between month, week, and to-do note view, select **Options** > **Month view**, **Week view**, or **To-do view**.

To change the starting day of the week, the view that is shown when you open the calendar, or the calendar alarm settings, select **Options** > **Settings**.

To go to a certain date, select **Options** > **Go to date**. To go to today, press #.

Save and edit names and numbers

1. Press , and select **Contacts** > **Options** > **New contact**.

Calendar and contacts

2. Fill in the fields that you want, and select **Done**.

To edit a contact card, select it, and **Options > Edit**. You can also search for the desired contact by entering the first letters of the name to the search field.

To attach an image to a contact card, open the contact card, and select **Options > Add image**. The image is shown when the contact calls.

Create contact groups

1. To create a new group, in the group list, select **Options > New group**. Use the default name or enter a new name. Select **OK**.
2. To add members to the group, select the group and **Options > Add members**.
3. Mark each contact you want to add, and select **OK**.

Add ringing tones for contacts

Press , and select **Contacts**.

To define a ringing tone for a contact or a contact group:

1. Press the scroll key to open a contact card or go to the groups list, and select a contact group.
2. Select **Options > Ringing tone**.
3. Select the ringing tone you want to use.

When a contact or group member calls you, the device plays the selected ringing tone (if the caller's phone number is sent with the call and your device recognises it).

To remove the ringing tone, select **Default tone** from the list of ringing tones.

9. Images and music

With your Nokia 6760 slide, you can capture images, and listen to music and radio. You can also share your images in different online services.

Camera

When you use the camera, the display is automatically rotated to landscape.







Capture an image

Select  > **Camera**.

To capture an image, use the display as a viewfinder, and press the capture key. The device saves the image in Gallery.

To zoom in or out before capturing an image, use the scroll key.

The toolbar provides you with shortcuts to different items and settings before and after capturing an image or recording a video clip. To view the toolbar, select **Options** > **Show toolbar**. Select from the following:

-  Switch to image mode.
-  Switch to video mode.
-  Activate sequence mode (images only).
-  Switch to night mode (video only).
-  Video length.
-  Close the toolbar.

The available options vary depending on the capture mode and view you are in. The settings return to the default values when you close the camera.

Record videos







Select  > **Camera**.

1. If the camera is in image mode, select video mode from the toolbar.
2. To start recording, press the capture key.
3. To pause recording, select **Pause**. Select **Continue** to resume recording.
4. To stop recording, select **Stop**. The video clip is automatically saved in Gallery. The maximum length of the video clip depends on the available memory.

Gallery

Select  > **Gallery**.

Select from the following:

- **Images**  — View images and videos in Photos.
- **Video clips**  — View videos in Video centre.
- **Songs**  — Open Music player.
- **Sound clips**  — Listen to sound clips.
- **Streaming links**  — View and open streaming links.
- **Presentations**  — View presentations.

Images and music

You can browse and open folders, and copy and move items to folders. You can also create albums and copy and add items to albums.

To open a file, press the scroll key. Video clips, RAM files, and streaming links open and play in Video centre, and music and sound clips in Music player.

Share online

About Share online

Select  > **Applications** > **Share online**.

With Share online, you can post your images, video clips, and sound clips from your device to compatible online sharing services, such as albums and blogs. You can also view and send comments to the posts in these services, and download content to your compatible Nokia device.

The supported content types and the availability of the Share online service may vary.

Subscribe to services

Select  > **Applications** > **Share online**.

To subscribe to an online sharing service, go to the service provider's website, and check that your Nokia device is compatible with the service. Create an account as instructed on the website. You receive a user name and password needed to set up your device with the account.

1. To activate a service, open the Share online application in your device, select a service and **Options** > **Activate**.

2. Allow the device to create a network connection. If you are prompted for an internet access point, select one from the list.
3. Sign in to your account as instructed on the service provider's website.

Nokia's services in the online sharing service are free of charge. Any data transferred over the network may incur charges from your service provider. For the availability and cost of the third party services and data transfer costs, contact your service provider or the relevant third party.

Create a post

Select  > **Applications** > **Share online**.

To post media files to a service, select a service and **Options** > **New upload**. If the online sharing service provides channels for posting files, select the desired channel.

To add an image, video clip, or sound clip to the post, select **Options** > **Insert**.

Enter a title or description for the post, if available.

To add tags to the post, select **Tags**.

To enable the posting of location information contained in the file, select **Location**.

To set the level of privacy for a file, select **Privacy**. To allow everyone to view your file, select **Public**. To restrict others from seeing your files, select **Private**. You can define the **Default** setting on the service provider's website.

To send the post to the service, select **Options** > **Upload**.

About Ovi Share

Ovi Share is an online service that helps you to share your images, video clips, audio, and other media on your computer or device with your family and friends. In Ovi Share, you can tag and comment on images, create lists of your favourites, and more. You must register to be able to share, but no registration is required to view the media that you share with others.

With your device, you can use the Share online application. For more information, see share.ovi.com.

Music player

Select  > **Music** > **Music player**.

Music player supports file formats such as AAC, AAC+, eAAC+, MP3, and WMA. Music player does not necessarily support all features of a file format or all the variations of file formats.

You can also use Music player to listen to podcast episodes. Podcasting is a method for delivering audio or video content over the internet using either RSS or Atom technologies for playback on mobile devices and PCs.

Play a song or a podcast episode

To add all available songs and podcasts to the music library, select **Options** > **Refresh library**.

To play a song or a podcast episode, select the desired category, and the song or podcast episode.

To pause playback, press the scroll key; to resume, press the scroll key again. To stop playback, scroll down.

To fast-forward or rewind, press and hold the scroll key to the right or left.

To skip to the next item, scroll right. To return to the beginning of the item, scroll left. To skip to the previous item, scroll left again within 2 seconds after a song or podcast has started.

To modify the tone of the music playback, select **Options** > **Equaliser**.

To modify the balance and stereo image, or to enhance bass, select **Options** > **Audio settings**.

To view a visualisation during playback, select **Options** > **Show visualisation**.

To return to the active standby mode and leave the player playing in the background, press the end key.

Nokia Music Store

Select  > **Music** > **Music store**.

In the Nokia Music Store (network service), you can search, browse, and purchase music to download to your PC and transfer to your device. To purchase music, you first need to register for the service.

To access the Nokia Music Store, you must have a valid internet access point in the device.

Nokia Music Store is not available for all countries or regions.

Nokia Music Store settings

The availability and appearance of the Nokia Music Store settings may vary. The settings may also be predefined and not editable. You may be asked to select the access point to use when connecting to the Nokia Music Store. Select **Default access point**.

In the Nokia Music Store, you may be able to edit the settings. Select **Options** > **Settings**.

Transfer music from PC

1. Ensure that a compatible memory card is inserted in the device.
2. Connect your device to the PC using Bluetooth connectivity or a compatible USB data cable.
3. If you are using a USB data cable, select **Media transfer** as the connection mode.

If you select **Media transfer** as the connection mode, you can use Windows Media Player to synchronise music between your device and PC.

FM radio

The FM radio depends on an antenna other than the wireless device antenna. A compatible headset or accessory needs to be attached to the device for the FM radio to function properly.



Listen to the radio

Select  > **Music** > **Radio**.

The quality of the radio broadcast depends on the coverage of the radio station in that particular area.

You can make a call or answer an incoming call while listening to the radio. The radio is muted when there is an active call.

To start a station search, select  or .

If you have saved radio stations in your device, to go to the next or previous saved station, select  or .

Select **Options** and from the following:

- **Activate loudspeaker** — Listen to the radio using the loudspeaker.
- **Manual tuning** — Change the frequency manually.
- **Station directory** — View available stations based on location (network service).
- **Save station** — Save the station to which you are currently tuned to your station list.
- **Stations** — Open the list of your saved stations.
- **Play in background** — Return to the standby mode while listening to the FM radio in the background.

RealPlayer

Select  > **Applications** > **RealPlayer**.

RealPlayer plays video and sound clips that are stored on your device, transferred from an e-mail message, or a compatible computer, or streamed to your device over the web.

Supported file formats include MPEG-4, MP4 (not streaming), 3GP, RV, RA, AMR, and Midi. RealPlayer does not necessarily support all variations of a media file format.

Play video clips and stream links

To play a video clip, select **Video clips**, and a clip.

To list recently played files, in the application main view, select **Recently played**.

To stream content over the air (network service), select **Streaming links** and a link. RealPlayer recognises two kinds of links: an rtsp:// URL and an http:// URL that points to a RAM file. Before the content begins streaming, your device must connect to a website and buffer the content. If a network connection problem causes a playback error, RealPlayer attempts automatically to reconnect to the internet access point.

To download video clips from the web, select **Download videos**.

To fast-forward during playback, scroll right and hold. To rewind during play, scroll left and hold.

To stop the playback or streaming, select **Stop**. Buffering or the connection to the streaming site stops, the playback of the clip stops, and the clip rewinds to the beginning.

To view the video clip in normal screen mode, select **Options > Continue in normal scr..**

RealPlayer settings

Select  > **Applications > RealPlayer**.

You may receive RealPlayer settings in a message from your service provider.

To define the settings manually, select **Options > Settings > Video or Streaming**.

10. Office applications

You can also use your device as a converter or calculator, or use the different applications to access attachments that you may have received in an e-mail.

Calculator

Select  > **Office** > **Calculator**.

This calculator has limited accuracy and is designed for simple calculations.

To make a calculation, enter the first number of the calculation. Select a function such as add or subtract from the function map. Enter the second number of the calculation, and select =. The calculator performs operations in the order they are entered. The result of the calculation remains in the editor field and can be used as the first number of a new calculation.

The device saves the result of the last calculation in its memory. Exiting the Calculator application or switching off the device does not clear the memory. To recall the last saved result the next time you open the Calculator application, select **Options** > **Last result**.

To save the numbers or results of a calculation, select **Options** > **Memory** > **Save**.

To retrieve the results of a calculation from the memory and use them in a calculation, select **Options** > **Memory** > **Recall**.

Convert measurements

Select  > **Office** > **Converter**.

1. Scroll to the type field, and select **Options** > **Conversion type** to open a list of measures. Select the measurement type to use (other than currency) and **OK**.
2. Scroll to the first unit field, and select **Options** > **Select unit**. Select the unit from which to convert and **OK**. Scroll to the next unit field, and select the unit to which to convert.
3. Scroll to the first amount field, and enter the value to convert. The other amount field changes automatically to show the converted value.

Find and organise files

Select  > **Office** > **File mgr..**

To find a file, select **Options** > **Find**. Enter a search term that matches the file name.

To move and copy files and folders, or to create new folders, select **Options** > **Organise**.



Shortcut: To apply actions to multiple items at once, mark the items. To mark or unmark items, press #.

Quickoffice

About Quickoffice

Select  > **Office** > **Quickoffice**.

Quickoffice consists of Quickword for viewing Microsoft Word documents, Quicksheet for viewing Microsoft Excel worksheets, Quickpoint for Microsoft PowerPoint presentations, and Quickmanager for purchasing software. You can view Microsoft Office 2000, XP, and 2003 documents (DOC, XLS, and PPT file formats) with Quickoffice. If you have the editor version of Quickoffice, you can also edit files.

Not all file formats or features are supported.

Work with files

To open a file, scroll to it, and press the scroll key.

To sort files according to the type, select **Options** > **Sort by**.

To view the details of a file, select **Options** > **Details**. The details include the name, size and location of the file, and the time and date when the file was last modified.

To send files to a compatible device, select **Options** > **Send** and the sending method.

Zip manager

Select  > **Office** > **Zip**.

With Zip manager, you can create new archive files to store compressed ZIP formatted files; add single or multiple compressed files or directories to an archive; set, clear, or

change the archive password for protected archives; and change settings, such as compression level, and file name encoding.

You can save the archive files in the device memory or on a memory card.

PDF reader

Select  > **Office** > **Adobe PDF**.

With PDF reader, you can read PDF documents on the display of your device; search for text in the documents; modify settings, such as zoom level and page views; and send PDF files using e-mail.

11. Downloads

You can download and install applications to your device.

Application manager

With Application manager, you can see the software packages installed in your device. You can view details of installed applications, remove applications, and define installation settings.

You can install two types of applications and software to your device:

- JME applications based on Java™ technology with the .jad or .jar file extensions
- Other applications and software suitable for the Symbian operating system with the .sis or .sisx file extensions

Only install software that is compatible with your device.

Install applications and software

You can transfer installation files to your device from a compatible computer, download them during browsing, or receive them in a multimedia message, as an e-mail attachment, or using other connectivity methods, such as Bluetooth connectivity. You can use Nokia Application Installer in Nokia PC Suite to install an application to your device.

Icons in Application manager indicate the following:

 .sis or .sisx application

 Java application

 application not fully installed



Important: Only install and use applications and other software from trusted sources, such as applications that are Symbian Signed or have passed the Java Verified testing.

Before installation, note the following:

- To view the application type, version number, and the supplier or manufacturer of the application, select **Options > View details**.
To display the security certificate details of the application, select **Details: > Certificates: > View details**.
- If you install a file that contains an update or repair to an existing application, you can only restore the original application if you have the original installation file or a full backup copy of the removed software package. To restore the original application, remove the application, and install the application again from the original installation file or the backup copy.

The JAR file is required for installing Java applications. If it is missing, the device may ask you to download it. If there is no access point defined for the application, you are asked to select one. When you are downloading the JAR file, you may need to enter a user name and password to access the server. You obtain these from the supplier or manufacturer of the application.

To install an application or software, do the following:

1. To locate an installation file, select  > **Applications** > **Installations** and **App. mgr.**. Alternatively, search installation files using File manager, or select **Messaging** > **Inbox**, and open a message that contains an installation file.
2. In Application manager, select **Options** > **Install**. In other applications, select the installation file to start the installation.

During installation, the device shows information about the progress of the installation. If you install an application without a digital signature or certification, the device displays a warning. Continue installation only if you are sure of the origin and contents of the application.

To start an installed application, select the application. If the application does not have a default folder defined, it is installed in the Installations folder in the main menu.

To see which software packages are installed or removed and when, select **Options** > **View log**.



Important: Your device can only support one antivirus application. Having more than one application with antivirus functionality could affect performance and operation or cause the device to stop functioning.

After you install applications to a compatible memory card, installation files (.sis, .sisx) remain in the device memory. The files may use large amounts of memory and prevent you from storing other files. To maintain sufficient memory, use Nokia

PC Suite to back up installation files to a compatible PC, then use the file manager to remove the installation files from the device memory. If the .sis file is a message attachment, delete the message from the Messaging inbox.

Remove applications and software

Select  > **Applications** > **Installations** > **App. mgr.**

Scroll to a software package, and select **Options** > **Uninstall**. Select **Yes** to confirm.

If you remove software, you can only reinstall it if you have the original software package or a full backup of the removed software package. If you remove a software package, you may no longer be able to open documents created with that software.

If another software package depends on the software package that you removed, the other software package may stop working. For more information, see the documentation of the installed software package.

Application manager settings

Select  > **Applications** > **Installations** > **App. mgr.**

Select **Options** > **Settings** and from the following:

- **Software installation** — Select whether Symbian software that has no verified digital signature can be installed.
- **Online certificate check** — Check the online certificates before installing an application.
- **Default web address** — Set the default address used when checking online certificates.

Downloads

Some Java applications may require that a message be sent or a network connection be made to a specific access point to download extra data or components.

Download!

Select  > **Download!**.

With Download! (network service), you can browse, download, and install items, such as latest applications and related documents, to your device from the web.

The items are categorised under catalogues and folders provided by Nokia or independent service providers. Some items may be chargeable, but you can usually preview them free of charge.

Download! uses available network connections to access the most up-to-date content. For information on additional items available through Download!, contact your service provider, or the supplier or manufacturer of the item.

Manage items

Select  > **Download!**.

To open an item or view the content of a folder or catalogue, select the item, folder, or catalogue.

To buy the selected item, select **Options** > **Buy**.

To download an item that is free of charge, select **Options** > **Get**.

To search for an item, select **Options** > **Search**.

To adjust the settings, select **Options** > **Applications** > **Settings**.

To view a list of downloaded items, select **Options** > **My items**.

Subscriptions

Select  > **Download!** and **Options** > **My items** > **My subscriptions**.

To view file details of the selected item, select **Options** > **Open**.

To renew or cancel a subscription, select **Options** and the corresponding option.

Download! search

Select  > **Download!** and **Options** > **Search**.

Scroll to the catalogues from which you want to search for items, select **Mark**, and enter the search keywords.

To start the search, select **Options** > **Search**.

Purchase history

Select  > **Download!** and **My items** > **My downloads**.

To open the selected item with the corresponding application, select **Options** > **Open**.

To view file details of the selected item, select **Options** > **View details**.

To start, pause, resume, or cancel the download of the selected item, select **Options** and the corresponding option.

Download! settings

Select  > **Download!**.

To change the Download! settings, select **Options** > **Settings** and from the following:

- **Network connection** — Select the network destination used for the network connection.
- **Connection type** — Select whether you want a confirmation query to be shown before the connection is created.
- **Automatic open** — Select whether you want the downloaded item or application to open automatically after the download is completed.
- **Preview confirmation** — Select whether you want a confirmation query to be shown before previewing an item.
- **Buy confirmation** — Select whether you want a confirmation query to be shown before buying an item.
- **Subscript. confirmation** — Define whether you want the subscription confirmation query to be shown before subscribing to an item.

12. Protect your device and data



Important: Your device can only support one antivirus application. Having more than one application with antivirus functionality could affect performance and operation or cause the device to stop functioning.

Lock the device

The lock code protects your device against unauthorised use. The preset code is 12345.

To lock the device, in the active standby, press the power key, and select **Lock phone**.

To unlock your device, select **Unlock**, enter the lock code, and select **OK**.

To change the lock code, select  > **Tools** > **Settings and General** > **Security** > **Phone and SIM card**. Enter the old code and then the new code twice. The new code can be 4-255 characters long. Both alphabets and digits can be used, and both uppercase and lowercase alphabets are possible.

Write down the new code, and keep it secret and in a safe place separate from your device. If you forget the lock code and your device is locked, you must take the device to a Nokia authorised service facility and additional charges may apply. To unlock the device, the software must be reloaded, and the data you have saved in the device may be lost.

You can also lock the device remotely by sending a text message to the device. To enable remote locking, and to

define the text for the message, select  > **Tools** > **Settings and General** > **Security** > **Phone and SIM card** > **Remote phone locking** > **Enabled**. Enter the remote lock message, and confirm the message. The message must be at least 5 characters long. Write down the text, as you may need it later.

Memory card security

Select  > **Office** > **File mgr..**

You can protect a memory card with a password to prevent unauthorised access. To set a password, select **Options** > **Memory card password** > **Set**. The password can be up to 8 characters long and is case-sensitive. The password is stored in your device. You do not need to enter it again while you use the memory card on the same device. If you use the memory card on another device, you are asked for the password. Not all memory cards support password protection.

To remove the memory card password, select **Options** > **Memory card password** > **Remove**. When you remove the password, the data on the memory card is not protected against unauthorised use.

To open a locked memory card, select **Options** > **Unlock memory card**. Enter the password.

If you cannot recall the password to unlock a locked memory card, you may reformat the card, in which case the card is

unlocked and password removed. Formatting a memory card deletes all data stored on the card.

Back up data

Select  > **Office** > **File mgr.**

It is recommended that you back up the device memory regularly to a memory card or a compatible computer.

To back up information from the device memory to a memory card, select **Options** > **Back up phone memory**.

To restore information from the memory card to the device memory, select **Options** > **Restore from mem. card**.

You can also connect your device to a compatible computer and use Nokia PC Suite to back up data.

Be careful when you connect

Your device supports several connectivity methods and, like computers, may be exposed to viruses and other harmful content. Exercise caution with messages, connectivity requests, browsing, and downloads.

Messages

- If you receive suspicious messages, do not open the attachments.



Important: Exercise caution when opening messages. Messages may contain malicious software or otherwise be harmful to your device or PC.

Bluetooth

Protect your device and data

- When you are not using Bluetooth connectivity, select **Bluetooth** > **Off** or **My phone's visibility** > **Hidden**.
- Do not pair with unknown devices or devices that you do not trust.

Browsing and downloads

- If you have tried to access or have accessed confidential information requiring passwords, empty the cache after each use. The information or services you have accessed are stored in the cache.



Important: Use only services that you trust and that offer adequate security and protection against harmful software.

13. Settings

Select  > **Tools** > **Settings**.

You can define and modify various settings of your device. Modifying these settings affects the operation of your device across several applications.

Some settings may be preset for the device or sent to you in a special message by your service provider. You may not be able to change such settings.

Select the setting you want to edit, and modify the values in the following ways:

- Switch between two values, such as on or off.
- Select a value from a list.
- Open a text editor to enter a value.
- Scroll left or right to adjust a value.

General settings

Select  > **Tools** > **Settings** and **General**.

Select from the following:

- **Personalisation** — Change the display settings, and personalise the device.
- **Date and time** — Change the date and time.
- **Enhancement** — Define the settings for your accessories.
- **Slide handling** — Change the slide settings.
- **My own key** — Change the function that is activated when you press the internet or messaging key.
- **Sensor settings** — Change the sensor settings.

- **Security** — Define the security settings.
- **Factory settings** — Restore the original settings of the device.
- **Positioning** — Define the positioning method and server for GPS-based applications.

Phone settings

Select  > **Tools** > **Settings** and **Phone**.

Select from the following:

- **Call** — Define general call settings.
- **Call divert** — Define call divert settings.
- **Call barring** — Define call barring settings.
- **Network** — Define the network settings.

Connection settings

Select  > **Tools** > **Settings** and **Connection**.

Select from the following:

- **Bluetooth** — Edit the Bluetooth settings.
- **USB** — Edit the data cable settings.
- **Destinations** — Define new or edit existing access points. Some or all access points may be preset for your device by your service provider, and you may not be able to create, edit, or remove them.
- **Packet data** — Define when packet data network is attached, and enter the default packet switched access

point name if you use your device as a modem for a computer.

- **Data call** — Set the length of the time-out period after which data call connections automatically end.
- **Presence** — Edit the settings for presence (network service). To register for the service, contact your service provider.
- **SIP settings** — View or create session initiation protocol (SIP) profiles.
- **XDM settings** — Create an XDM profile. The XDM profile is required for many communications applications, for example, presence.
- **Remote drives** — Connect the device to a remote drive.
- **Configurations** — View and delete trusted servers from which your device may receive configuration settings.
- **APN control** — Restrict packet data connections.

Application settings

Select  > **Tools** > **Settings** and **Applications**.

Select an application from the list to adjust its settings.

14. Green tips

Here are tips on how you can contribute to protecting the environment.



Save energy

When you have fully charged the battery and disconnected the charger from the device, unplug the charger from the wall outlet.

You do not need to charge your battery so often if you do the following:

- Close and disable applications, services, and connections when not in use.
- Decrease the brightness of the screen.
- Set the device to enter the power saver mode after the minimum period of inactivity, if available in your device.
- Disable unnecessary sounds, such as keypad and ringing tones.

Recycle

Most of the materials in a Nokia phone are recyclable. Check how to recycle your Nokia products at www.nokia.com/werecycle, or with a mobile device, www.nokia.mobi/werecycle.

Recycle packaging and user guides at your local recycling scheme.

Save paper

This user guide helps you get started with your device. For more detailed instructions, open the in-device help (in most applications, select **Options** > **Help**). For further support, see www.nokia.com/support.

Learn more

For more information on the environmental attributes of your device, see www.nokia.com/ecodeclaration.

Accessories



Warning: Use only batteries, chargers, and accessories approved by Nokia for use with this particular model. The use of any other types may invalidate any approval or warranty, and may be dangerous. In particular, use of unapproved chargers or batteries may present a risk of fire, explosion, leakage, or other hazard.

For availability of approved accessories, please check with your dealer. When you disconnect the power cord of any accessory, grasp and pull the plug, not the cord.

Battery

Battery and charger information

Your device is powered by a rechargeable battery. The battery intended for use with this device is BP-4L. Nokia may make additional battery models available for this device. This device is intended for use when supplied with power from the following chargers: AC-8. The exact charger model number may vary depending on the type of plug. The plug variant is identified by one of the following: E, EB, X, AR, U, A, C, K, or UB.

The battery can be charged and discharged hundreds of times, but it will eventually wear out. When the talk and standby times are noticeably shorter than normal, replace the battery. Use only Nokia approved batteries, and recharge your battery only with Nokia approved chargers designated for this device.

If a battery is being used for the first time or if the battery has not been used for a prolonged period, it may be necessary to connect the charger, then disconnect and reconnect it to begin charging the battery. If the battery is completely discharged, it may take several minutes before the charging indicator appears on the display or before any calls can be made.

Safe removal. Always switch the device off and disconnect the charger before removing the battery.

Proper charging. Unplug the charger from the electrical plug and the device when not in use. Do not leave a fully charged battery connected to a charger, since overcharging may

shorten its lifetime. If left unused, a fully charged battery will lose its charge over time.

Avoid extreme temperatures. Always try to keep the battery between 15°C and 25°C (59°F and 77°F). Extreme temperatures reduce the capacity and lifetime of the battery. A device with a hot or cold battery may not work temporarily. Battery performance is particularly limited in temperatures well below freezing.

Do not short-circuit. Accidental short-circuiting can occur when a metallic object such as a coin, clip, or pen causes direct connection of the positive (+) and negative (-) terminals of the battery. (These look like metal strips on the battery.) This might happen, for example, when you carry a spare battery in your pocket or purse. Short-circuiting the terminals may damage the battery or the connecting object.

Disposal. Do not dispose of batteries in a fire as they may explode. Dispose of batteries according to local regulations. Please recycle when possible. Do not dispose as household waste.

Leak. Do not dismantle, cut, open, crush, bend, puncture, or shred cells or batteries. In the event of a battery leak, prevent battery liquid contact with skin or eyes. If this happens, flush the affected areas immediately with water, or seek medical help.

Damage. Do not modify, remanufacture, attempt to insert foreign objects into the battery, or immerse or expose it to water or other liquids. Batteries may explode if damaged.

Correct use. Use the battery only for its intended purpose. Improper battery use may result in a fire, explosion, or other hazard. If the device or battery is dropped, especially on a hard surface, and you believe the battery has been damaged, take it to a service centre for inspection before continuing to use it. Never use any charger or battery that is damaged. Keep your battery out of the reach of small children.

Safe removal. Always switch the device off and disconnect the charger before removing the battery.

Nokia battery authentication guidelines

Always use original Nokia batteries for your safety. To check that you are getting an original Nokia battery, purchase it from a Nokia authorised service centre or dealer, and inspect the hologram label using the following steps:

Authenticate hologram

1. When you look at the hologram on the label, you should see the Nokia connecting hands symbol from one angle and the Nokia Original Enhancements logo when looking from another angle.



2. When you angle the hologram left, right, down and up, you should see 1, 2, 3 and 4 dots on each side respectively.



Successful completion of the steps is not a total assurance of the authenticity of the battery. If you cannot confirm authenticity or if you have any reason to believe that your Nokia battery with the hologram on the label is not an authentic Nokia battery, you should refrain from using it, and take it to the nearest Nokia authorised service centre or dealer for assistance.

To find out more about original Nokia batteries, see www.nokia.com/battery.

Taking care of your device

Your device is a product of superior design and craftsmanship and should be treated with care. The following suggestions will help you protect your warranty coverage.

- Keep the device dry. Precipitation, humidity, and all types of liquids or moisture can contain minerals that will corrode electronic circuits. If your device does get wet, remove the battery, and allow the device to dry completely before replacing it.
- Do not use or store the device in dusty, dirty areas. Its moving parts and electronic components can be damaged.
- Do not store the device in high or cold temperature. High temperatures can shorten the life of electronic devices, damage batteries, and warp or melt certain plastics. When the device warms to its normal temperature from a cold temperature, moisture can form inside the device and damage electronic circuit boards.
- Do not attempt to open the device other than as instructed in this guide.
- Do not drop, knock, or shake the device. Rough handling can break internal circuit boards and fine mechanics.
- Do not use harsh chemicals, cleaning solvents, or strong detergents to clean the device. Only use a soft, clean, dry cloth to clean the surface of the device.
- Do not paint the device. Paint can clog the moving parts and prevent proper operation.
- Use only the supplied or an approved replacement antenna. Unauthorised antennas, modifications, or

attachments could damage the device and may violate regulations governing radio devices.

- Use chargers indoors.
- Backup all data you want to keep, such as contacts and calendar notes.
- To reset the device from time to time for optimum performance, power off the device and remove the battery.

These suggestions apply equally to your device, battery, charger, or any accessory.

Recycle

Always return your used electronic products, batteries, and packaging materials to dedicated collection points. This way you help prevent uncontrolled waste disposal and promote the recycling of materials. Check product environmental information and how to recycle your Nokia products at www.nokia.com/wecycle, or nokia.mobi/wecycle.



The crossed-out wheeled-bin symbol on your product, battery, literature, or packaging reminds you that all electrical and electronic products, batteries, and accumulators must be taken to separate collection at the end of their working life. This requirement applies in the European Union. Do not dispose of these products as unsorted municipal waste. For more environmental information, see the product Eco-Declarations at www.nokia.com/environment.

Additional safety information

Small children

Your device and its accessories are not toys. They may contain small parts. Keep them out of the reach of small children.

Operating environment

This device meets RF exposure guidelines in the normal use position at the ear or at least 2.2 centimetre (7/8 inch) away from the body. Any carry case, belt clip, or holder for body-worn operation should not contain metal and should position the device the above-stated distance from your body.

To send data files or messages requires a quality connection to the network. Data files or messages may be delayed until such a connection is available. Follow the separation distance instructions until the transmission is completed.

Medical devices

Operation of any radio transmitting equipment, including wireless phones, may interfere with the functionality of inadequately protected medical devices. Consult a physician or the manufacturer of the medical device to determine if they are adequately shielded from external RF energy or if you have any questions. Switch off your device in health care facilities when any regulations posted in these areas instruct you to do so. Hospitals or health care facilities may be using equipment that could be sensitive to external RF energy.

Implanted medical devices

Manufacturers of medical devices recommend that a minimum separation of 15.3 centimetres (6 inches) should be maintained between a wireless device and an implanted medical device, such as a pacemaker or implanted cardioverter defibrillator, to avoid potential interference with the medical device. Persons who have such devices should:

- Always keep the wireless device more than 15.3 centimetres (6 inches) from the medical device when the wireless device is turned on.
- Not carry the wireless device in a breast pocket.
- Hold the wireless device to the ear opposite the medical device to minimise the potential for interference.
- Turn the wireless device off immediately if there is any reason to suspect that interference is taking place.
- Read and follow the directions from the manufacturer of their implanted medical device.

If you have any questions about using your wireless device with an implanted medical device, consult your health care provider.

Hearing aids

Some digital wireless devices may interfere with some hearing aids. If interference occurs, consult your service provider.

Vehicles

RF signals may affect improperly installed or inadequately shielded electronic systems in motor vehicles such as electronic fuel injection, electronic antilock braking, electronic speed control, and air bag systems. For more information, check with the manufacturer of your vehicle or its equipment.

Only qualified personnel should service the device or install the device in a vehicle. Faulty installation or service may be dangerous and may invalidate your warranty. Check regularly that all wireless device equipment in your vehicle is mounted and operating properly. Do not store or carry flammable liquids, gases, or explosive materials in the same compartment as the device, its parts, or accessories. Remember that air bags inflate with great force. Do not place your device or accessories in the air bag deployment area.

Switch off your device before boarding an aircraft. The use of wireless teledevices in an aircraft may be dangerous to the operation of the aircraft and may be illegal.

Potentially explosive environments

Switch off your device in any area with a potentially explosive atmosphere. Obey all posted instructions. Sparks in such areas could cause an explosion or fire resulting in bodily injury or death. Switch off the device at refuelling points such as near gas pumps at service stations. Observe restrictions in fuel depots, storage, and distribution areas; chemical plants; or where blasting operations are in progress. Areas with a potentially explosive atmosphere are often, but not always,

clearly marked. They include areas where you would be advised to turn off your vehicle engine, below deck on boats, chemical transfer or storage facilities and where the air contains chemicals or particles such as grain, dust, or metal powders. You should check with the manufacturers of vehicles using liquefied petroleum gas (such as propane or butane) to determine if this device can be safely used in their vicinity.

Emergency calls



Important: This device operates using radio signals, wireless networks, landline networks, and user-programmed functions. If your device supports voice calls over the internet (internet calls), activate both the internet calls and the cellular phone. The device may attempt to make emergency calls over both the cellular networks and through your internet call provider if both are activated. Connections in all conditions cannot be guaranteed. You should never rely solely on any wireless device for essential communications like medical emergencies.

To make an emergency call:

1. If the device is not on, switch it on. Check for adequate signal strength. Depending on your device, you may also need to complete the following:
 - Insert a SIM card if your device uses one.
 - Remove certain call restrictions you have activated in your device.

- Change your profile from Offline or Flight profile to an active profile.
2. Press the end key as many times as needed to clear the display and ready the device for calls.
 3. Enter the official emergency number for your present location. Emergency numbers vary by location.
 4. Press the call key.

When making an emergency call, give all the necessary information as accurately as possible. Your wireless device may be the only means of communication at the scene of an accident. Do not end the call until given permission to do so.

Certification information (SAR)

This mobile device meets guidelines for exposure to radio waves.

Your mobile device is a radio transmitter and receiver. It is designed not to exceed the limits for exposure to radio waves recommended by international guidelines. These guidelines were developed by the independent scientific organisation ICNIRP and include safety margins designed to assure the protection of all persons, regardless of age and health.

The exposure guidelines for mobile devices employ a unit of measurement known as the Specific Absorption Rate or SAR. The SAR limit stated in the ICNIRP guidelines is 2.0 watts/kilogram (W/kg) averaged over 10 grams of tissue. Tests for SAR are conducted using standard operating positions with the device transmitting at its highest certified power level in all tested frequency bands. The actual SAR level of an operating device can be below the maximum value because

the device is designed to use only the power required to reach the network. That amount changes depending on a number of factors such as how close you are to a network base station.

The highest SAR value under the ICNIRP guidelines for use of the device at the ear is 0.85 W/kg.

Use of device accessories may result in different SAR values. SAR values may vary depending on national reporting and testing requirements and the network band. Additional SAR information may be provided under product information at www.nokia.com.

Index

A

- access codes 10
- alarm
 - calendar note 43
- alarm clock 24
- animated screen saver 26
- anniversary notes 43
- antennas 25
- application manager 52
- application settings 59
- applications 23, 52
- assisted GPS (A-GPS) 30
- audio messages 22
- auto-update for time/date 24

B

- background image 26
- backing up data 57
- battery
 - charging 15
 - inserting 13
- birthday notes 43
- blogs 37
- Bluetooth
 - authorising devices 40
 - pairing 40
 - passcode 40
 - receiving data 40

- sending data 40
- browser 36
 - cache memory 37
 - security 38

C

- cache memory 37
- calculator 50
- calls
 - answering 20
 - making 20
 - voice mail 20
- camera
 - capturing images 45
 - toolbar 45
 - video clips 45
- chat services (IM) 29
- Clock
 - settings 25
- connection methods
 - Bluetooth 40
- contacts
 - creating groups 44
 - editing 43
 - images in 44
 - ringing tones 44
 - saving 43
- converting
 - measurements 50

D

- data connections 42
- date and time 24
- display
 - changing the look 26
- Download!
 - managing items 54
 - purchase history 54
 - search settings 54
 - settings 55
 - subscriptions 54

E

- e-mail 28

F

- feeds, news 37
- FM radio 48

G

- Gallery 45
- GPS
 - position requests 32
- GPS (global positioning system) 30

H

- headset 16

HSDPA 38

I

IM (instant messaging) 29

indicators 23

installing applications 52

internet connection 36

See also *browser*

J

Java applications 52

JME Java application support 52

K

keyboard 21

keypad lock 16

keys 12, 28, 36

L

landmarks 32

location information 30

lock code 10, 56

locking

device 56

M

mail for exchange 28

Maps 33

maps

browsing 34

navigating 34

routes 34

measurements

converting 50

media

radio 48

meeting notes 43

meetings

setting up 43

memo notes

See *to-do notes*

memory

web cache 37

memory card 16, 17

backing up data 57

locking 56

passwords 56

menus 23

MMS (multimedia message service) 22

multimedia messages 22

music player

playing 47

transferring music 48

music store 47

N

navigation tools 30

news feeds 37

Nokia Music Store 47

Nokia support information 9

O

Ovi Mail 28

Ovi Share 47

P

pairing

devices 40

passcode 40

PDF reader 51

personalisation 26

phone setup 19

PIN code 10

PIN2 code 10

playing

video and audio 49

positioning information 30

profiles

creating 26

customising 26

selecting ringing tones 26

PUK codes 10

Q

Quickoffice 51

R

radio 48

listening 48

RealPlayer

playing media clips 49

Index

- settings 49
- remote lock 56**
- ringing tones**
 - in profiles 26
- S**
- screen saver 26**
- security**
 - memory card 56
 - web browser 38
- security code 10, 56**
- sending**
 - using Bluetooth 40
- settings 10**
 - applications 59
 - clock 25
 - Download! application 55
 - RealPlayer 49
- settings wizard 19**
- Share online 46**
 - activating services 46
 - creating posts 46
 - subscribing 46
- sharing media files online 46**
- shortcuts 17**
- SIM card**
 - inserting 13
- SMS (short message service) 22**
- software applications 52**
- support resources 9**
- Switch 19**

- Switch application 11**
- switching device on or off 15**
- Symbian applications 52**

T

- text entry 21**
- text messages**
 - sending 22
- themes**
 - changing 26
- time and date 24**
- time zone settings 24**
- to-do notes 43**

U

- uploading media files 46**
- USB data cable 38**

V

- video clips**
 - playing 49
- voice mail**
 - calling 20
 - changing number 20
- volume control 21**

W

- web connection 36**
- web logs 37**

- week settings**
 - calendar alarm 43
- world clock 24**

Z

- Zip manager 51**