

HP iPAQ
Product Guide



© Copyright 2007 Hewlett-Packard
Development Company, L.P.

HP iPAQ products are powered by
Microsoft® Windows Mobile® 6 Professional
with Messaging and Security Feature Pack.

Microsoft Windows, the Windows logo,
Outlook, Windows Mobile Device Center,
and ActiveSync are trademarks of Microsoft
Corporation in the U.S. and other countries.



Java

POWERED Java and all Java-based
trademarks and logos are trademarks or
registered trademarks of Sun Microsystems,
Inc. in the U.S. and other countries.



SD Logo is a trademark of its
proprietor.

Bluetooth® is a trademark owned by its
proprietor and used by Hewlett-Packard
Development Company, L.P. under license.

Google and Google Maps are trademarks of
Google Inc.

All other product names mentioned herein
may be trademarks of their respective
companies.

Hewlett-Packard Company shall not be liable
for technical or editorial errors or omissions
contained herein. The information is
provided "as is" without warranty of any kind
and is subject to change without notice. The
warranties for Hewlett-Packard products are
set forth in the express limited warranty
statements accompanying such products.
Nothing herein should be construed as an
additional warranty.

This document contains proprietary
information that is protected by copyright. No
part of this document may be photocopied,
reproduced, or translated to another
language without the prior written consent of
Hewlett-Packard Development Company,
L.P.

January 2008

Document Part Number: 455719-001

Table of contents

1 Register your HP iPAQ

2 Box contents

3 Components

Front panel components	3
Top and bottom panel components	4
Left and right panel components	5
Back panel components	6

4 Set up your HP iPAQ

Step 1: Remove the battery cover and insert the SIM card	7
Step 2: Install the battery and replace the battery cover	8
Step 3: Charge the battery	9
Step 4: Turn on your HP iPAQ	9
Find the serial and model number	9
Status icons	10

5 Learn the basics

The Today screen	12
Enter text	12
Customize your HP iPAQ	14
Device name	14
Enter owner information	14
Change the regional settings	14
Adjust the volume	15
Change the power management settings	15
Dim or adjust the brightness of the backlight	15
Install and remove programs	16
Open and close programs	16
Set alarms and clocks	17
Shortcut menus	17
Display the clock in the title bar	17
Create and assign a category	17
Adjust the speed for scrolling through items in a list	18
View the Operating System (OS) information	18
Lock and unlock your HP iPAQ	18
Battery saving tips	19

6 Use your Business Navigator

Use the keypad	20
3-Way Thumb-Wheel	20

Call features	20
Make a call	20
Answer a call	20
Call waiting	21
Redial a number	21
Call a contact	21
Make a call from the Today screen	21
Make a call from the contacts	21
Make emergency calls	21
Make calls using speed dial	22
Voice mail	22
Handsfree function	22
Make data calls	23
Mute a call	23
Put a call on hold	23
Make a conference call	23
Make a call from a hyperlink phone number	23
Dial international numbers	24
Call history	24
Manage calls using call history	24
Make calls using call history	24
View call details	24
Voice commands	24
Check connection and signal strength	25
Change the SIM PIN	26
Change service settings	26
Change phone service settings	26
Forward calls	26
Configure caller ID	27
Block calls	27
Set up voice mail or text messaging center number	27
Change network settings	28
Change phone network settings	28
View available phone networks	28
Set preferred networks	28
Manually select a phone network	29
Change the ring tone and ring type	29
Take notes during a call	29
Select a frequency band automatically	29
Copy a contact from a SIM to a device	30
Add Tele-typewriter (TTY) functionality	30
Add TTY functionality for people who are hearing impaired or hard-of-hearing	30
Enable TTY support	31
Make a phone call using the TTY enabled HP iPAQ	31
Disable TTY support	31
Voice notes	32
Create voice notes	32
Delete voice notes	32
Listen to voice notes	33
Rename voice notes	33

Configure channels	33
Notes	33
Write a note	34
Create a copy of a note	34

7 Camera

Use the camera	35
Capture photos	35
View photos	35
Camera settings	35
Basic settings	36
Photo settings	36
Video recorder	36
Record videos	36
Configure video format	37
Video settings	37
Options for camera and video recorder	37
Transfer images	38
Use GPRS	38
Use Bluetooth	38

8 HP Photosmart Mobile

View pictures stored on your HP iPAQ or a storage card	39
Attach a voice note to a picture	39
Print using Storage Card	40
View a slideshow	40
E-mail pictures	40
Associate a picture with a contact	41
Assign a picture to the Today screen background	41
Snapfish	41
Enhance documents	41
Set the screen saver	42
Switch to camera application	42
Organize images	42
Send an image to clipboard	43
Video support	43

9 Storage cards

Use storage cards	44
Insert a storage card	44
Remove a storage card	45
View contents of a storage card	45

10 Synchronization

Synchronization software	46
Copy files	46
Migrate data from Palm Desktop to Microsoft Windows Mobile 6	47
Wireless synchronization cost saving tips	47
Troubleshoot synchronization issues	48

Customized links in WMDC	50
11 Tasks	
Set start and due dates for a task	51
Show start and due dates in the task list	51
Set options for displaying tasks on the Today screen	51
Mark a task as completed	51
12 Messaging	
Understand messages	53
Folder types	53
Synchronize e-mail	54
Set up messaging accounts	54
Set up e-mail using Exchange Server	54
Internet e-mail	55
Create a new POP3 or IMAP4 account	55
Change e-mail download options	56
Delete an account	57
Text messaging	57
MMS	57
MMS composer	57
Receive attachments	58
Receive meeting requests	59
Create or change a signature	59
Use messaging	60
Compose and send messages	60
Reply or forward a message	60
Add an attachment to a message	60
Download messages	61
Download messages from a server	61
Install an online address book	61
13 Calendar	
Access calendar	63
Change the display of the work week	63
Set a default reminder for all new appointments	63
Update an appointment	63
Cancel an appointment	64
14 Contacts	
Create a contact	65
Delete a contact	65
Change contact information	65
Copy a contact	65
Find a contact	66
Send an E-mail message to a contact	66
Send a text message to a contact	66
Add and remove a picture	67
Use the contact list	67

15 Connections

Use Wireless Manager	69
Wi-Fi	69
Wi-Fi Terms	70
Open Wi-Fi settings	70
Automatically connect to a Wi-Fi network	70
Manually connect to a Wi-Fi network	71
Find an IP address	71
Delete a Wi-Fi network	71
Bluetooth	71
Bluetooth terms	71
Open Bluetooth settings	72
Connect to a computer using Bluetooth	72
Create, end, and accept a Bluetooth partnership	73
Edit a Bluetooth partnership	74
Use your HP iPAQ as a wireless modem with Bluetooth	74
Bluetooth device profiles	75
Access services	75
Set a Bluetooth shared folder	75
Set up an incoming or outgoing Bluetooth COM port	75
GPRS/EDGE/HSDPA	76
GPRS/EDGE	76
HSDPA	76
Differences between GSM and GPRS/EDGE/WCDMA/3G technology	76
Configure GPRS network settings	76
Edit an Internet connection	77
Edit MMS settings	78
Edit WAP information settings	79
Troubleshoot automatic detection	80
Advanced settings	80
Connect to intranet URLs	80
Change an intranet URL	80
Set up an automatic choice for connections	80
Set up a WAP gateway	81
Configure advanced proxy settings	81
Advanced connection settings	82
Set up a VPN server connection	82
Change a connection group name	82
End a connection	83

16 Google Maps™ for mobile

Launch and navigate Google Maps	84
Google Search	84
Launch Google Search	85

17 Using Global Positioning System (GPS) on your HP iPAQ

18 Applications

HP applications	87
-----------------------	----

HP Help and Support	87
HP VoiceReply	87
HP iPAQ Setup Assistant	88
HP Shortcuts	89
Use HP Shortcuts	89
Edit HP Shortcuts	89
HP iPAQ DataConnect	89
HP Asset Viewer	90
HP CertEnroller	90
HP iPAQ Tips	91
HP iPAQ Mobile Broadband Connect	91
HP Enterprise Mobility Agent	91
HP iPAQ File Store	91
HP iPAQ Ring Tone Manager	92
Manage certificates	92
iPAQ Audio	92
Keyguard	93
Voice Commander	93
Internet Explorer	93
Remote Desktop Mobile	94
Windows Media Player	94
Clear the Now Playing List	94
Update a Library	95
Use Voice Commander to play media files	95
Office Mobile applications	95
Word Mobile	95
Excel Mobile	95
PowerPoint Mobile	96
Games	97
Bubble Breaker	97
Solitaire	97
Internet Sharing	97
To connect to a laptop using a USB data connection	98
To connect to a laptop using Bluetooth data connection	98
Internet Explorer	99
Windows Live Messenger	99
Sign in and out of messenger	99
Send instant messages	100
Change your status	100
SMS cell broadcast	100
SIM Toolkit	100
SIM Manager	101
Power	101
Backlight	101
19 Product specifications	102
System specifications	102
Physical specifications	102
Operating environment	103

20 Regulatory notices

Federal Communications Commission Notice	104
Modifications	104
Cables	104
Declaration of Conformity for Products Marked with the FCC Logo (United States Only)	104
Canadian Notice	105
Avis Canadien	105
European Union Notice	105
Products with 2.4–GHz Wireless LAN Devices	106
France	106
Italy	106
Battery Warning	106
Battery Recycling	106
Battery Disposal	106
Disposal of Waste Equipment by Users in Private Household	107
Equipment Warning	114
Acoustics Warning	114
Class 1 LED Product	114
Airline Travel Notice	115
Medical Electronic Equipment	115
SAR Notice	115
Wireless Notices	115
U.S. Regulatory Wireless Notice	116
Canadian Regulatory Wireless Notice	116
Brazilian Notice	116
Singaporean Wireless Notice	116
Japanese Notice	117
Wireless LAN 802.11b Devices	117
Wireless LAN 802.11g Devices	117
Bluetooth Devices	117
Taiwan DGT Notice	117
Korean Notice	118

21 Frequently Asked Questions

I am having trouble turning on my HP iPAQ. What should I do?	119
I am unable to make or receive calls. How do I fix this?	119
I have trouble connecting to the Internet. What should I do?	120
I am unable to hear voices clearly. How do I resolve this?	120
When I answer calls on my iPAQ, the caller is unable to hear my voice clearly. What could be the problem?	120
I cannot use certain call functions. What should I do?	120
Why do I hear noises in the background during a phone call?	120
How can I improve the standby time and talk time on my HP iPAQ?	120
Why does the HP iPAQ operate slowly sometimes?	121
I have trouble charging my battery. What should I do?	121
I am unable to synchronize my HP iPAQ with my computer. What should I do?	121
Which factors degrade the GPS signal and affect accuracy?	121
My HP iPAQ was connected while I was installing WMDC. But, WMDC does not launch even after installation?	122

Can I set up an active connection between my HP iPAQ and a computer using Bluetooth for the first time?	122
---	-----

22 Safety information

General Precautions	123
Safety Precautions for Power Cords and Accessories	124
Safety Precautions for Battery Packs	124
Safety Precautions for Docking Devices	125
Safety Precautions for Products with Wireless Devices	125
Safety Precautions for Products with Modems, Telecommunications or Local Area Network Accessories	125
Safety Precautions for Products with Laser Devices	125
CDRH Regulations	126

23 Guidelines for care and maintenance

Use your HP iPAQ	127
Cleaning your HP iPAQ	127
Carrying or storing your HP iPAQ	127
Use accessories	127

1 Register your HP iPAQ

You need to register your HP iPAQ with Hewlett-Packard to be able to:

- Access support and services, and get the most out of your HP products.
- Manage your profile.
- Sign up for free support alerts, software updates, and personalized newsletters.

After registering your HP iPAQ, you will receive an e-mail message regarding special offers and promotions. Visit <http://www.register.hp.com> to register your HP iPAQ or update your mail or e-mail address after registration. You are required to enter your user ID and registration password to edit your profile online.

 **NOTE:** Registration is not supported in all countries/regions.

2 Box contents

This illustration depicts the items that come in the box with your HP iPAQ.

 **NOTE:** Box contents might vary by model.

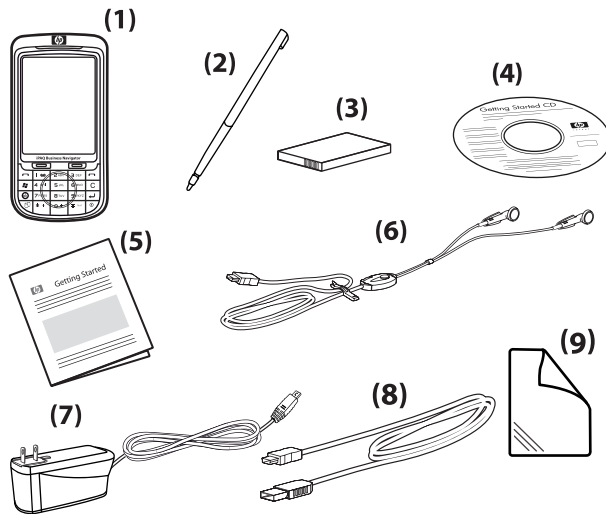

(1)	HP iPAQ 600 Series Business Navigator
(2)	Stylus
(3)	1590 mAh Li-polymer removable/rechargeable battery
(4)	<i>Getting Started</i> CD with additional software
(5)	HP iPAQ documentation
(6)	Wired stereo headset NOTE: Listening to personal stereo equipment at full volume for long periods can damage hearing. To reduce the risk of hearing loss, do not spend much time listening to personal stereo equipment at full volume. HP recommends use of the headset manufactured by Merry, part number 455673-001, that is included with your HP iPAQ.
(7)	AC adapter
(8)	Mini-USB charging/synchronization cable
(9)	Screen protector film

3 Components

Know the different components of your HP iPAQ.

 **NOTE:** Not all models or features are available in all countries/regions.

Front panel components

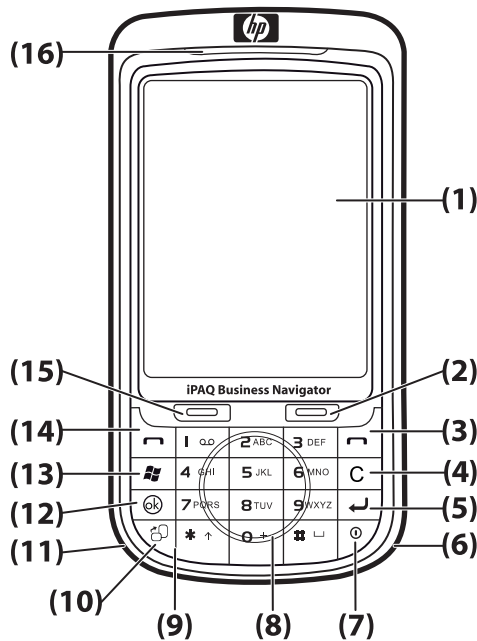

Component		Function
(1)	Touch Screen Display	Use to view the contents on the screen. Use stylus to select items, navigate menus, change feature settings, and play games.
(2)	Right Softkey	Press to launch HP Shortcuts from the Today screen.
(3)	End Key	Press to end a phone call.
(4)	Back Space/Clear Key	Press back space/clear and clear text one at a time.
(5)	Enter Key	Press to open an application or insert a line break while typing messages.
(6)	Wi-Fi antenna	Detects Wi-Fi hotspots. NOTE: This component will not be visible externally.
(7)	Power Key	Press to switch to standby mode. Press and hold to switch your HP iPAQ on or off.
(8)	Smart-Touch Navigation Wheel	Use to navigate and scroll through items on the screen.

Component		Function
(9)	Keyboard	Use keys on the keyboard to enter text, dial numbers, or navigate menus.
(10)	Landscape/Portrait Key	Press to switch between the landscape and portrait views.
(11)	Bluetooth Antenna	Detects and radiates Bluetooth signals. NOTE: This component will not be visible externally.
(12)	ok Key	Press to confirm your selection.
(13)	Windows Key	Press to display the Start menu.
(14)	Answer/Send Key	Press to answer a call or to view the on-screen keypad.
(15)	Left SoftKey	Press to launch Messaging from the Today screen.
(16)	LEDs	<ul style="list-style-type: none"> • Solid Amber – Charging • Flashing Amber – One or more notifications received • Solid Green – Fully charged • Flashing Red – Low battery warning • Flashing Green – Within GPRS/GSM/EDGE/WCDMA/3G coverage area • Flashing Blue – Wi-Fi or Bluetooth on • Blue Off – Wi-Fi and Bluetooth off

Top and bottom panel components

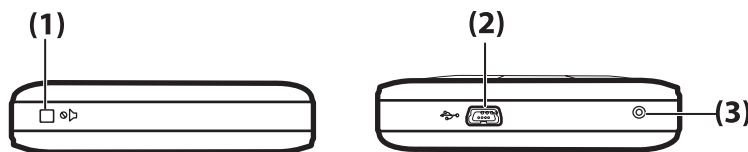

Component		Function
(1)	Mute Key	Use to set your HP iPAQ in silent mode.
(2)	Charging/Communications Port	Use to connect the mini-USB charging/synchronization cable (WMDC for Windows Vista and ActiveSync for Windows XP).
(3)	Reset	Use to soft reset your HP iPAQ. WARNING! Resetting your HP iPAQ before turning it off might corrupt data present on your HP iPAQ. You will lose unsaved data on performing a soft reset.

Left and right panel components

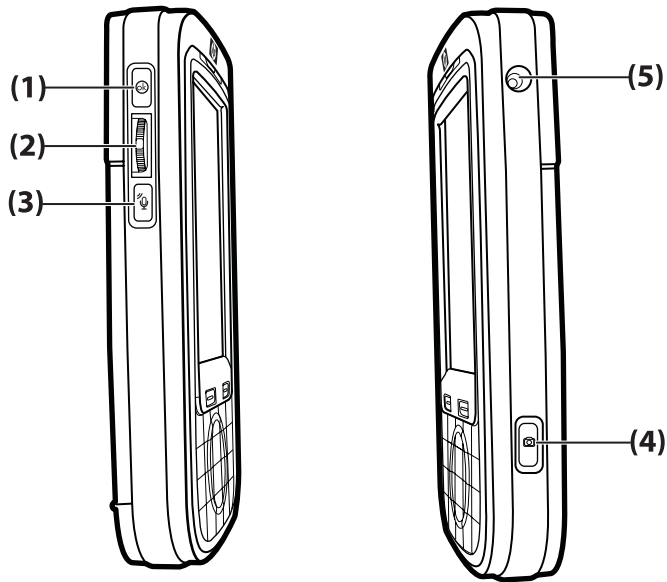

Component		Function
(1)	ok Key	Press to confirm your selection.
(2)	3-Way Thumb-Wheel	Use to navigate and scroll through items on the screen and confirm your selection. During a call, move the wheel up or down to increase or decrease the volume.
(3)	Voice Commander Key	Press to launch the Voice Commander application.
(4)	Camera Key	Press to use the camera and capture photos. NOTE: The camera is not available on all models.
(5)	External GPS Antenna Connector	Use to connect an external GPS antenna.

Back panel components

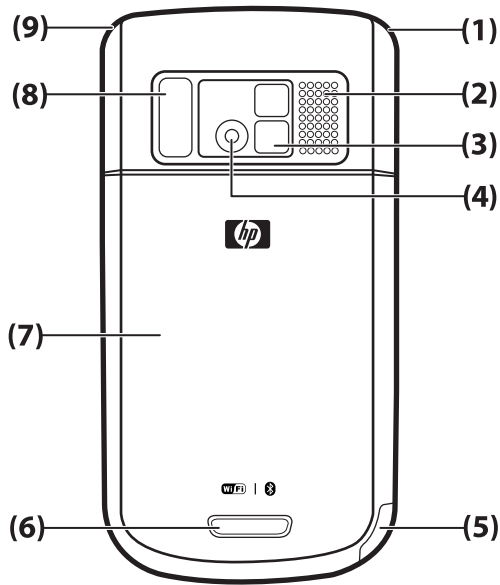

Component		Function
(1)	Main antenna	Detects phone signals. NOTE: This component will not be visible externally.
(2)	Back Speaker	Use the speaker to listen to music or as a speakerphone.
(3)	Self Portrait Mirror	Use the mirror lens to center your own image for a self-photograph.
(4)	Camera	With the camera turned on, frame the subject in the camera lens and view it on your HP iPAQ screen before capturing the photo. NOTE: The camera is not available on all models.
(5)	Stylus	Remove and use to select elements on the screen and input information. Slide down to remove the stylus. Slide up to place the stylus.
(6)	Cover Latch	Press the cover latch on the battery cover and slide the cover down and away from the HP iPAQ.
(7)	Battery Cover	Remove to insert or remove the battery, SIM card, or SD card.
(8)	Flash Light	Turn on the flash light while capturing pictures in dim light.
(9)	GPS antenna	Detects GPS signals. NOTE: This component will not be visible externally.

4 Set up your HP iPAQ

Step 1: Remove the battery cover and insert the SIM card

To remove the battery cover and insert the SIM card:

1. Press the cover latch on the battery cover and slide the cover down and away from the HP iPAQ.

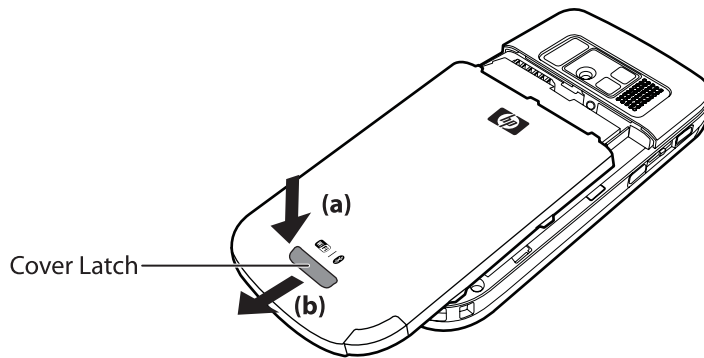

2. Slide the SIM card slot cover and lift to open it.

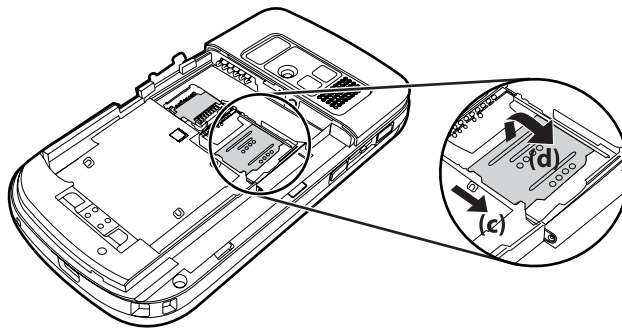

3. Place the SIM card into the SIM card slot.

 **NOTE:** Make sure that the metal contacts are facing down and the notched corner is in the correct position.

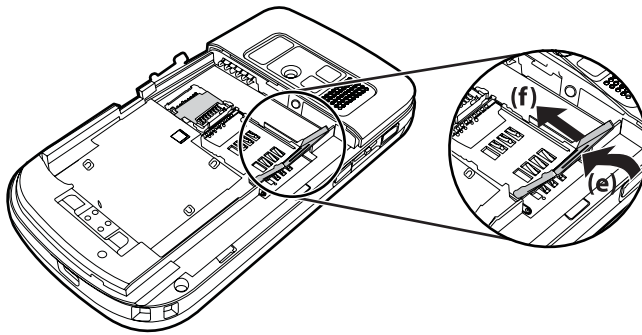

4. Slide back the SIM card slot cover until it locks into place.

Step 2: Install the battery and replace the battery cover

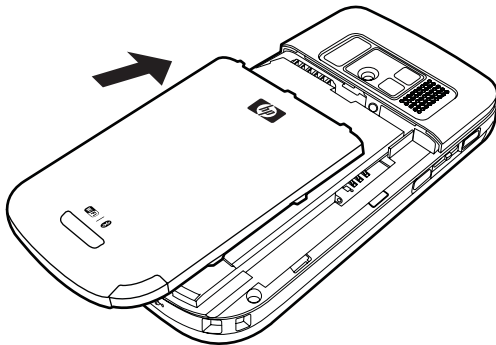
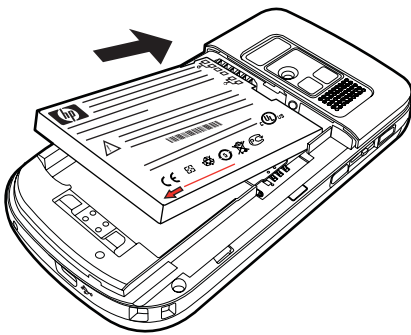

To install the battery and replace the battery cover:

1. Align the battery connectors on the battery with the housing pins in the battery compartment, and insert the battery.
2. Place the battery cover down and slide up until it locks into place.

Step 3: Charge the battery

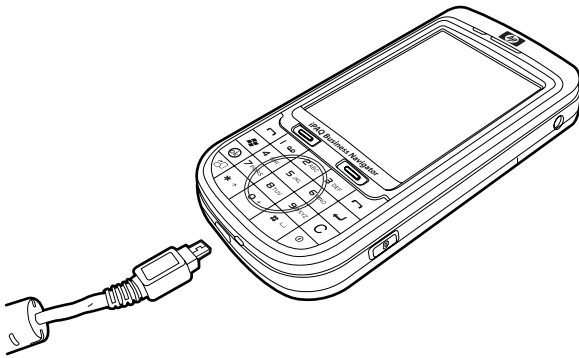

△ **CAUTION:** To avoid damaging your HP iPAQ or the AC adapter, make sure all connectors are properly aligned before connecting.

The battery provides power for your HP iPAQ to operate. Use the mini-USB synchronization cable, that comes with your HP iPAQ, to charge the device.

It takes approximately 2-4 hours to fully charge the battery for the first time. Subsequent charges might take longer.

To charge the battery:

1. Insert the USB end of the mini-USB synchronization cable into the port on the AC adapter.
2. Connect the AC adapter to an electrical outlet.
3. Connect the mini-USB synchronization cable to the charging/communications port on your HP iPAQ. The cable connector only fits one way. If the connector does not insert easily, turn it over.

💡 **TIP:** You can also charge the battery by connecting your HP iPAQ to a USB port on your computer using the mini-USB synchronization cable. To enable USB charging on your iPAQ, tap **Start > Settings > System > Power > USB Charging**. On the **Power** screen, select the **Use USB Charging** check box.

📝 **NOTE:** Whenever a replacement battery is inserted into your HP iPAQ, press the **Power** key for at least two seconds. In case the device does not turn on, attach an AC adapter to turn on your HP iPAQ.

Step 4: Turn on your HP iPAQ

Press and hold the **Power** key for a few seconds to turn on your HP iPAQ. Next, follow the instructions on the screen to complete the setup. Use the on-screen keypad to enter information.

📝 **NOTE:** The HP iPAQ will take a few minutes for the initial boot up. The keypad will not be active during this period.

Find the serial and model number

Locate the serial and model numbers before contacting HP Customer Support, particularly if you are calling for in-warranty support.

View the serial and model number by tapping **Start > Programs > HP Help and Support > Serial and Model Number**.







To locate the serial and model number:





1. Remove the battery cover.
2. Remove the battery from the unit.
3. Locate the label containing the product ID and serial number underneath the battery.

 **NOTE:** Tap **Start > Settings > System > HP Asset Viewer > Identity** to view the serial number and tap **Start > Settings > System > HP Asset Viewer > System** to view the model number on your HP iPAQ. For more information, see [HP Asset Viewer on page 90](#).

Status icons

The following table lists the common status indicators and their meanings.

Icon	Status	Icon	Status
	Missed call		Call forwarding active
	Voice call active		Call on hold
	No SIM card installed		SIM card fault
	New Voice mail		New e-mail or SMS
	Instant message received		Battery level
	Battery level low		Battery charging
	Silent mode on		Sync error
	Ringer off		Speaker phone on
	Wi-Fi on		Bluetooth
	Roaming		General Packet Radio Service (GPRS) available
	GPRS available in roaming		GPRS in use
	Enhanced Data Rates for GSM Evolution (EDGE) available		EDGE available in roaming
	EDGE in use		Signal strength

Icon	Status	Icon	Status
	Phone connection unavailable or network error		Radio off
	3G on		HSDPA on

5 Learn the basics

Get started with your HP iPAQ by learning the basic functions such as knowing the **Today** screen, entering text, and synchronizing data.

The Today screen

The **Today** screen displays the date and time and provides a quick status of the upcoming appointments, your current profile, and the number of unread text messages. At the top of the **Today** screen, connectivity icons, volume indicator, battery indicator, and clock are displayed.

To customize the **Today** screen:

1. Tap **Start > Settings > Personal > Today**.
2. On the **Appearance** tab, select the required theme for the background of the **Today** screen.
3. On the **Items** tab, select the items to appear on the **Today** screen.

 **TIP:** To move the order in which the items appear, tap **Start > Settings > Personal > Today**. On the **Items** tab, tap **Move Up** or **Move Down**.

 **NOTE:** There are two default softkeys on the bottom of the **Today** screen: **Messaging** and **HP Shortcuts**. On the **Today** screen, the **Messaging** softkey is also the **Notification** softkey. Any type of alert, such as a meeting reminder, is displayed on the **Today** screen as a notification.

Enter text

Based on your preference, you can use the on-screen keypad or a handwriting recognition feature such as **Block Recognizer**, **Keyboard**, **Letter Recognizer**, or **Transcriber** to enter text.

 **NOTE:** Transcriber is not available in all countries/regions.



To enter text:

1. Tap **Start > Settings > Personal > Input**.
2. On the **Input method** tab, select a text input method and change options as appropriate.
3. Tap **ok**.

You can now go to a program (such as Notes) and start entering text.

Text-Input Method	Definition
Block Recognizer	Use a single stroke to write letters, numbers, symbols, and punctuation marks that get converted into typed text.
Keyboard	Tap keys on the keyboard to enter text.
Letter Recognizer	Write individual letters, numbers, and punctuation marks that are converted into typed text.
Transcriber	Write in cursive, print, or mixed handwriting (consisting of both cursive and print), and convert your writing into typed text.

Text-Input Method	Definition
	NOTE: Not available in all countries/regions.
XT9	Use this mode for different text entry options.

 **TIP:** Change the text-input method from within any program by tapping the  (Input selector) arrow and selecting an input method. To switch between XT9 and multipress mode while entering text, press and hold * key on the keypad.

 **NOTE:** To disable the **Smart-Touch Navigation** wheel while entering text, press and hold the **ok** key on the left panel of your HP iPAQ.

Press and hold * key on the keypad to view the available XT9 options:

 **NOTE:** Before you enter text using XT9, make sure you disable the on-screen keyboard by tapping anywhere on the screen.

Label	Description
XT9 English	<p>This mode supports the following features:</p> <ul style="list-style-type: none"> • Visible selection list – Displays words from the entire XT9 vocabulary in a list at the bottom of the screen as you compose a message. • Word completion – Populates the first two letters of a word as you type, and populates the selection list with words that are derived from the letters you typed. • Spell correction – Adds spell corrected words to the selection list. • Auto-Substitution – Converts shortcut entries into longer words or phrases. • Auto-Append – Constructs words that are not in the dictionary.
ABC	<p>Press a text-entry key on the keypad repeatedly to cycle around to the desired character.</p> <p>NOTE: Text entry in this mode does not have regional error correction, word completion, next word prediction, spell correction, or auto substitution.</p>
123	Enter numerals using this mode.
Symbols	Enter symbols by navigating through the symbols page using the arrow keys.
Language	<p>Select the language of your choice.</p> <p>IMPORTANT: XT9 may not be supported in all countries.</p>
XT9 Settings	<p>Enable or disable the following features for XT9:</p> <ul style="list-style-type: none"> • Spell Corrections • Next Word Completion • Auto-Append • Auto-Substitution

Label	Description
	<ul style="list-style-type: none"> • Word Completion • Multitap Word Completion
About XT9	View XT9 version information.

Customize your HP iPAQ

Device name

The device name is used to identify the HP iPAQ in the following situations:

- Synchronizing with a computer
- Connecting to a network

 **NOTE:** If you synchronize multiple devices with the same computer, each device must have a unique name.

To change the device name:

1. Tap **Start > Settings > System > About > Device ID**.
2. Enter a name for the device. The device name must begin with a letter, consist of letters from A to Z, numbers from 0 to 9, and the special character underscore (_). The device name cannot contain spaces.

To get detailed information about your HP iPAQ:

- Tap **Start > Settings > System > About**.

The **Version** tab displays important device information, including the type of processor and the amount of memory installed.

Enter owner information

You can enter your personal information, such as your name and address, so that the HP iPAQ can be returned to you if it is lost.

To enter owner information:

1. Tap **Start > Settings > Personal > Owner Information**.
2. On the **Identification** tab, enter your personal information.

 **TIP:** You can edit the owner information directly from the **Today** screen. To be able to do so, you need to select the **Owner Information** check box while customizing the **Today** screen. For more information, see [The Today screen on page 12](#).

Change the regional settings

The style in which regions, numbers, currency, time, and date are displayed is specified in regional settings.

To change the regional settings:

1. Tap **Start > Settings > System > Regional Settings > Region**.
2. Select a region.
The region you select determines the options available on the other tabs.
3. To customize additional settings, tap the appropriate tabs and select the required options.
 - On the **Region** tab, select the required region display options.
 - On the **Number** tab, select the required number display options.
 - On the **Currency** tab, select the required currency display options.
 - On the **Time** tab, select the required time display options.
 - On the **Date** tab, select the required date display options.

Adjust the volume

You can change the volume for various sounds, such as the sound you hear when you tap program names and menu options.

To adjust volume:

1. Tap  (Speaker) icon at the top of the screen.
2. Move the system volume slider on the screen using the stylus, **3-Way Thumb-Wheel**, or the **Smart-Touch Navigation** wheel of your HP iPAQ to the required volume level.
3. To mute system sounds, tap **Off**.

 **TIP:** To switch to silent mode, press the **Mute** key on the top of your HP iPAQ.

You can also set a specific sound for a specific event.

To set sounds:

1. Tap **Start > Settings > Personal > Sounds & Notifications**.
2. On the **Sounds** tab, choose how you want to be notified by selecting the appropriate check boxes.
3. On the **Notifications** tab, in the **Event** list, tap an event name and choose how you want to be notified by selecting the appropriate check boxes. You can choose from several options, such as a special sound, a message, or a flashing light.

 **NOTE:** Turning off sounds and the LED notification helps conserve battery power.

Change the power management settings

To change the power management settings:

1. Tap **Start > Settings > System > Power**.
2. Tap **Advanced** and select the length of time the HP iPAQ stays on when using battery power or AC power.

Dim or adjust the brightness of the backlight

You can set the backlight to dim after a specified amount of time has elapsed.

To dim the backlight after a certain time:

1. Tap **Start > Settings > System > Backlight**.
2. Tap **Battery power** or **External Power**.
3. Select the backlight options of your choice.

You can also increase or decrease the brightness of the backlight.

To adjust the brightness of the backlight:

1. Tap **Start > Settings > System > Backlight > Brightness**.
2. Move the slider on the **Backlight** screen up or down to set the required level of brightness.

 **TIP:** Tap to select the slider, and then use the **3-Way Thumb-Wheel** or the **Smart-Touch Navigation** wheel to increase or decrease brightness.

Install and remove programs

You can install or remove programs on your HP iPAQ

To install programs:

1. Use the WMDC or ActiveSync (WMDC for Windows Vista and ActiveSync for Windows XP) to connect your HP iPAQ to your computer.
2. Follow the instructions in the Installation Wizard provided with the program you want to install.
3. Check the screen of your HP iPAQ to see if any further steps are necessary to complete the program installation.

To remove programs:

1. Tap **Start > Settings > System > Remove Programs**.
2. Select the check box for the programs you want to remove, and then tap **Remove**.

 **NOTE:** You may remove programs you install on your iPAQ, however you will be unable to remove programs that were installed when you purchased your HP iPAQ.

 **NOTE:** By removing a program from your HP iPAQ, you might increase available memory on the device. You can also remove the unused programs from your device to increase the available memory.

If programs are lost from your HP iPAQ for any reason, most of them can be re-installed using any synchronization software. On your computer, click **Options > Add/Remove Programs >** check the program to be added > click **OK**.

Open and close programs

You do not need to exit a program to open another or to conserve memory. The system manages memory automatically.

To open a program, tap **Start**, and then tap the program you want from the list. If you do not see the program you want, tap **Start > Programs**.

In most cases, programs automatically stop to free required memory. However, you can choose to close programs manually.

To close programs:

1. Tap **Start > Settings > System > Memory > Running Programs**.
2. In the **Running Programs** list, tap the program you want to close, and then tap **Stop**.

Set alarms and clocks

You can change time and set alarms on your HP iPAQ.

To set alarm:

1. Tap **Start > Settings > System > Clock & Alarms > Alarms**.
2. Tap **<Description>** to enter a name for the alarm.
3. Tap the day of the week for the alarm. You can select multiple days by tapping each required day.
4. Tap the time display that appears near the alarm name and set the time for the alarm.
5. Tap  (Alarm) icon to specify the type of alarm. You can choose single sound or a repeating sound.
6. If you choose to play a sound, tap the list next to the **Play sound** check box, and then tap the sound you want to set.

To set time:

1. Tap **Start > Settings > System > Clock & Alarms > Time**.
2. Select **Home** to set the time zone, local time, and date when you are in your home country. Select **Visiting** to set these options while traveling.

Shortcut menus

A shortcut menu is displayed when you tap and hold an item. This menu displays the most common commands for a specific item. For example, you can delete an appointment or send a text message to a contact by using commands on a shortcut menu.

When the shortcut menu is displayed, tap the action you want to perform.

To close a shortcut menu without performing an action, tap anywhere outside the menu.

Display the clock in the title bar

When viewing certain programs, the clock might not be displayed in the title bar. You can set your HP iPAQ to display the clock in the title bar.

To display the clock in the title bar of all programs:

1. Tap **Start > Settings > System > Clock & Alarms**.
2. On the **More** tab, tap to select the **Display the clock on the title bar in all programs** check box.

Create and assign a category

In the **Calendar**, **Contacts**, and **Tasks** programs, you can use categories to organize and group your appointments, contacts, and tasks.

To create and assign a category:

1. From the list, select an existing item or create a new one.
2. Do one of the following:
 - For an existing item in **Calendar**, open the appointment and tap **Menu > Edit > Categories**.
 - For an existing item in **Tasks**, open the task and tap **Edit > Categories**.
 - For an existing item in **Contacts**, open the contact and tap **Menu > Edit > Categories**.
3. Select the required check box (**Business**, **Holiday**, **Personal**, or **Seasonal**) and tap **ok** to assign the category.
4. Tap **ok** to return to the appointment, task, or contact.

 **NOTE:** To assign a category to a contact, the contact needs to be saved on the phone memory.

 **NOTE:** To create a new category, tap **New** and assign a name to the category for a contact, task, or an appointment. The new category is assigned automatically to the item.

Adjust the speed for scrolling through items in a list

To change the speed at which scrolling occurs:

1. Tap **Start > Settings > Personal > Buttons > Up/Down Control**.
2. Under **Delay before first repeat**, move the slider to reduce or increase the time that elapses before scrolling begins.
3. Under **Repeat rate**, move the slider to change the time it takes to scroll from one item to the next.

View the Operating System (OS) information

You can view details like OS information, processor, memory, and expansion slot on your HP iPAQ.

To view the operating system information on your HP iPAQ.

- Tap **Start > Settings > System > About**.

The OS version gets displayed on the screen.

Lock and unlock your HP iPAQ

You can secure data on your HP iPAQ by setting a password. Each time you turn on your HP iPAQ, you will be prompted to enter the password to unlock it. Alternatively, you can also lock your screen to prevent key press while traveling.

To lock the screen:

1. Tap **Start > Settings > Personal > Lock**.
2. Select the **Prompt if device unused for** check box. Then, select the amount of time your HP iPAQ should remain unused before you are prompted to enter the password.
3. In the **Password type** list, select the type of password you would like to use. Next, enter the password, and then confirm the password.

4. On the **Hint** tab, enter a phrase to help you remember your password. Make sure that your hint does not allow others to guess your password. The hint is displayed after the wrong password is entered five times in a row.
5. When prompted, tap **ok**. The next time your HP iPAQ is unused for the specified amount of time, you are prompted to enter your password.

 **TIP:** Use the same steps as above to change or reset your password.

To unlock the screen:

1. Tap **Start > Settings > Personal > Lock**.
2. Clear the **Prompt if device unused for** check box.

Battery saving tips

You can adjust the settings on your HP iPAQ to fit your individual needs and to help your battery last as long as possible between charges. Here are some recommendations to conserve battery life:

- **Sounds** – Every time you are notified of an event, battery power is consumed. Tap **Start > Settings > Personal > Sounds & Notifications** to turn off any unnecessary notifications.
- **Auto Turn Off the Backlight** – Tap **Start > Settings > System > Backlight**. Specify a short amount of wait before turning off the backlight. On the **Battery Power** tab, set **Turn off backlight if device is not used for** to 10 seconds.
- **Turn off Bluetooth and Wi-Fi** – Always turn off Bluetooth and Wi-Fi when not in use.

HP also offers a variety of accessories to keep your HP iPAQ charged when you are out of the office for extended time periods. These include the mini-USB synchronization cable (WMDC for Windows Vista and ActiveSync for Windows XP) and AC adapter. Use original HP batteries and chargers to charge your HP iPAQ.

To check the battery power, tap **Start > Settings > System > Power** or tap  (Battery icon) on the **Today** screen.

 **NOTE:** In case of a battery drain out, you will lose any unsaved data on your iPAQ.

 **WARNING!** Removing the battery from your HP iPAQ before turning it off might corrupt data present on your HP iPAQ.

6 Use your Business Navigator

Use the keypad

Use the keypad of your HP iPAQ to answer or end calls, to dial numbers, to write messages, and to perform other basic functions. You can also use the **Smart-Touch Navigation** wheel to navigate through the onscreen menus.

Use the Smart-Touch Navigation wheel in any of the following ways:

- Move your finger over the wheel in both clockwise and anticlockwise directions to scroll through items on the screen.
- Move your finger in north to south or east to west directions to scroll through items one after another. Place your finger on number 5 on the keypad and then move your finger to scroll.

 **NOTE:** To disable the **Smart-Touch Navigation** wheel, press and hold the **ok** key on the left panel of your HP iPAQ. Once you disable the **Smart-Touch Navigation** wheel, the  (Wheel Lock) icon displays on the top of the screen. To enable the **Smart-Touch Navigation** wheel, press and hold the **ok** key on the left panel of your HP iPAQ.

3-Way Thumb-Wheel

Use the **3-Way Thumb-Wheel** to navigate through on-screen menus, play songs, change settings, and view information. Press the **3-Way Thumb-Wheel** to select an application. You can also use the **3-Way Thumb-Wheel** to increase or decrease the speaker volume during a call by moving it up and down.



Call features

Use the call features on your HP iPAQ.

Make a call

To make a call:

1. Press the  (Answer/Send) key.
2. Use the on-screen keypad to enter the number you want to call.
3. Tap **Talk**.

 **TIP:** You can also make a call by dialing the numbers using the keypad, and then pressing the  (Enter) key.

Answer a call

To answer a call, press the  (Answer/Send) key.

When you receive a call, you can answer or ignore the call. When the phone stops ringing, the caller might be sent to Voice Mail, depending on the settings provided by your mobile phone service provider. To ignore the call, tap **Ignore** on the on-screen keypad or press the  (End) key.



Call waiting

Use call waiting to be notified of incoming calls when you are on another call.

To turn on call waiting:

1. Press the  (Answer/Send) key.
2. Tap **Menu > Options... > Services**.
3. Tap **Call Waiting > Get Settings...**
4. Under **When calls are waiting**, tap **Notify me**.

To use call waiting to answer an incoming call during a phone conversation:

1. Press the  (Answer/Send) key to move the current phone call to call waiting.
2. Press the  (Answer/Send) key to answer the incoming call or tap **Ignore** if you do not want to answer the call.
3. Tap **Swap** to switch between the calls.

Redial a number

To redial the last number, press the  (Answer/Send) key twice.

Call a contact

You can call a number stored in the contact list. As you enter a contact's name, the HP iPAQ searches the **Contacts**, **Call History**, **Speed Dial** lists, and the SIM card to find a matching name and number.

Make a call from the Today screen

To make calls from the **Today** screen:

1. Use the keyboard to enter the contact number.
2. Press the  (Answer/Send) key to make the call.

Make a call from the contacts

You can select a person's name from your contact's list and press the  (Answer/Send) key to place the call. If a contact has more than one phone number, such as **Work**, **Home**, and **Fax**, do the following:

To make calls from the contacts list:

1. Tap **Start > Contacts**.
2. Scroll to the contact name.
3. Scroll to the required number and press the  (Answer/Send) key or tap the contact to place a call.

 **TIP:** If you have a long list of contacts, enter the first few letters of a contact's name. Your HP iPAQ searches the entire contact's list to display the name.



Make emergency calls

You can make calls to emergency service numbers, even if you have locked the SIM card and/or the HP iPAQ.

Your service provider programs one or more emergency phone numbers, such as 911 or 112, which you can call under any circumstances, even when your HP iPAQ is locked or the SIM card is not inserted.

To dial an emergency number:

1. Press the  (Answer/Send) key.

 **NOTE:** You need to turn on the phone before you make any emergency calls. To turn the phone on, tap , and then tap **Phone**.

2. Use the on-screen keypad to dial the local emergency number.
3. Press the  (Answer/Send) key to place the call.

 **NOTE:** Emergency numbers vary by country/region. Your HP iPAQ's preprogrammed emergency number(s) might not work in all locations, and sometimes an emergency call cannot be placed due to network, environmental, or interference issues.

Make calls using speed dial

You can dial phone numbers quickly by assigning speed dial numbers. You can choose speed dial entries from 2-99. The speed dial entry 1 is often reserved to set up or dial your Voicemail after the initial setup.

 **NOTE:** The **Speed Dial** feature is available only for phone numbers stored in the contact's list.

To create a speed dial shortcut:

1. Press the  (Answer/Send) key > **Speed Dial**.
2. Tap **Menu > New**.
3. Tap the contact and select a speed dial number from 2-99 in the **Location** box and tap **ok**.

 **NOTE:** You can also assign speed dial by tapping **Start > Contacts**, select a contact and tap **Menu > Add to Speed Dial...**

 **TIP:** You can also assign speed dial numbers to Web addresses and e-mail addresses that are stored in the **Contacts** on your HP iPAQ.

To make a speed dial call:

1. Press the  (Answer/Send) key.
2. On the screen keypad, tap and hold the number you assigned as a speed dial entry. For two-digit speed dial numbers, press the first digit and press and hold the second digit of the number.

Voice mail

To call Voice mail:

1. Press the  (Answer/Send) key.
2. On the screen keypad, tap and hold **1** to automatically call Voice Mail.

Handsfree function

You can turn the speaker on during a call to use the handsfree function.

- On the screen, tap **Speaker On** to turn the earpiece off.

Make data calls

Use connection settings to set up General Packet Radio Service (GPRS), dial-up, Virtual Private Network (VPN), proxy, and Wi-Fi connections to connect to the Internet or your corporate network. With a data connection, you can browse the Web, download e-mail, or synchronize with the server without using cables.

 **NOTE:** Your HP iPAQ has already been configured to allow you to browse and chat. Contact your service provider for information on mobile Internet plans, configuring e-mail, or wireless synchronizing with the server.

Mute a call

You can mute the microphone during an active call. On muting a call the other party will not be able to hear anything you say, but you can still hear the other party.

To mute the microphone during a call:

1. Tap **Mute** on the **Dialer** screen.
2. To disable the mute option, tap **Unmute** on the **Dialer** screen.

Put a call on hold

During a call, you can put the call on hold and dial another number or answer an incoming call. If you have more than one call on the line, you can switch between calls.

- To put a call on hold, tap **Hold**.
- To switch between calls, tap **Swap**.

 **NOTE:** The **Swap** feature is available only after you attend a call in waiting.

These buttons are available only on **Phone Dialer** screen.

Make a conference call

To make a conference call:

1. Press the  (Answer/Send) key.
2. On the screen keypad, dial the required number.
3. Tap **Talk**.
4. Once you are connected, tap **Hold**.
5. Dial the second number, and then tap **Talk**.
6. Once you are connected, tap **Menu > Conference**.

 **NOTE:** To add more parties to the conference call, dial each number, connect, and then tap **Menu > Conference**.

Make a call from a hyperlink phone number

Use a hyperlinked phone number to quickly dial a phone number from an e-mail or text message. A hyperlinked phone number is underlined in the same manner as a Web site address.

From an e-mail or text message containing a hyperlinked phone number:

1. Tap the phone number.
2. Tap **Talk** to dial the number.

Dial international numbers

To make an international call, enter a country code before the phone number:

1. Press the  (Answer/Send) key.
2. On the screen or the keypad, tap and hold **0** until the plus (+) sign displays.
3. Enter the country code and phone number.

 **NOTE:** You can also insert a plus (+) sign into a contact's phone number for quick dialing.

Call history

Manage calls using call history

Call history provides the time and duration of all incoming, outgoing, and missed calls, a summary of total calls, and has easy access to notes taken during a call.

- Press the  (Answer/Send) key > **Call History** to view the history of all dialed and received calls.
- Tap **Menu** > **Filter** and select a different view to change the call history view.

 **NOTE:** Tap **Menu** > **Call Timers...** to view call durations. The **All Calls** timer cannot be reset.

- Tap **Call History** > **Menu** > **Delete All Calls** to clear the entire call history.

Make calls using call history

Use call history to quickly call someone whom you recently called or someone who recently called you.

To make calls using call history:

1. Press the  (Answer/Send) key.
2. On the screen keypad, tap **Call History**.
3. Tap the required number twice or tap **Call** to place a call.

View call details

To view call details:

1. On the screen, tap **Call History**.
2. Tap the phone number of the contact to view the details.

The date and timestamp, as well as the duration of the call, are displayed.

Voice commands

Use voice commands to look up contacts, dial a contact by name, get calendar information, play and control your music, and launch applications on your HP iPAQ.

Press the **Voice Commander** button on the left panel (third button from the top) of your HP iPAQ to launch the **Voice Commander** application. Wait for the audio cue to say **Say command**, and then begin saying a command into the microphone.

 **NOTE:** You can also launch the **Voice Commander** by pressing the hook switch on your HP iPAQ headset.

To...	Say...
Call a contact saved in the contact list	Call followed by the name of the contact and home/work/mobile
Find a contact saved in the contact list	Find followed by the name of the contact
To call numbers not stored in the contact list	Digit Dial followed by the digits in the number, Redial to redial the number, and Callback to call the last dialed number Important! The Digit Dial feature might not be available in all countries/regions.
To play, pause, and/or resume music	Play Music/Pause/Resume
To play an existing music file	Play followed by the name of the music file
To play the previous or the next song in the playlist	Previous/Next
To open an application	Start followed by the application name
View appointments	< Today's/Tomorrow's/This Week's appointments > to list the appointments for the day, next day, or the present week
Read messages, e-mails, check Call History	Read<SMS/E-mail>/Call history
View time	What time is it?
View the different set of commands	What can I say?
To close Voice Commander application	Goodbye
To compose an e-mail	Compose E-mail To (Contact)
To compose an audio e-mail	Compose Audio E-mail To (Contact) to start recording an audio message
To dial a number using speed dial	Speed Dial followed by the digit assigned to the number
To record an audio note	Start Recording to open the voice recorder and start recording
To create reminders	Reminder
To schedule a call	Schedule A Call To (Contact) to call a contact

Check connection and signal strength

When you slide your SIM card into your HP iPAQ, your unit automatically connects to your mobile phone service provider's network. The  (Signal strength) icon indicates that you are connected. The more the vertical bars, the better the connection.

Change the SIM PIN

For security purposes, the SIM PIN protects your HP iPAQ against unauthorized access. You can assign a password to protect your device and information. Your first PIN comes from your wireless service provider.

To change the SIM PIN:

1. Press the  (Answer/Send) key.
2. Tap **Menu > Options...**
3. Under **Phone**, tap **Change PIN**.
4. Enter your old PIN.
5. Tap **Enter**.
6. Enter and confirm your new PIN.
7. Tap **ok**.

To enter a PIN before you make calls, check **Require PIN when phone is used**.

 **NOTE:** Emergency calls can be placed at any time, without entering a PIN.

To remove the SIM PIN:

1. Enter the PIN to access your device.
2. Press  (Answer/Send) key on the keyboard.
3. Tap **Menu > Options**.
4. Clear the **Require PIN when phone is used** check box and tap **ok**.

Change service settings

Change phone service settings

Once your phone service is set up through your mobile phone service provider, you can change service settings on your HP iPAQ. For example, you might want to block certain types of incoming and/or outgoing calls, forward incoming calls to a different phone number, be notified of incoming calls when you are already in a phone session, or let others know your identity when making calls.

To change phone service settings:

1. Press the  (Answer/Send) key.
2. On the screen, tap **Menu > Options... > Services**.
3. Tap the service you want to change, and then tap **Get Settings...**
4. Make appropriate changes and tap **ok**.

Forward calls

If you do not wish to receive calls on your HP iPAQ, you can forward the calls to some other number of your choice.

To set call forward:

1. Press the  (Answer/Send) key.
2. Tap **Menu > Options... > Services**.
3. Tap **Call Forwarding > Get Settings...**
4. Select the **Forward all incoming phone calls** check box.
5. Enter the phone number that is to receive the forwarded calls.

You can set numbers for the following:

- **No answer** – phone cannot be answered.
- **Unavailable** – phone is off.
- **Busy** – line is busy.

Configure caller ID

Configure caller ID to enable the telephone network to display your identity on the recipient's caller ID display.

To configure caller ID:

1. Press the  (Answer/Send) key.
2. Tap **Menu > Options... > Services**.
3. Tap **Caller ID > Get Settings...**
4. Select who do you want your identity displayed to and then tap **ok**.

To prevent your identity from being displayed to others, tap **No one**.

Block calls

If you do not wish to receive calls from certain numbers, you can block the numbers on your HP iPAQ.

To block calls:

1. Press the  (Answer/Send) key.
2. Tap **Menu > Options... > Services**.
3. Tap **Call Barring > Get Settings...**
4. Select the type of calls you want to block.

Set up voice mail or text messaging center number

To use voice mail or send text messages (SMS), enter the correct voice mail or text message phone number in phone settings.

 **NOTE:** Sending text messages is not included in all network service plans. Ask your mobile service provider if your plan includes this service.

To set up voice mail or text messaging center number:

1. Press the  (Answer/Send) key.
2. Tap **Menu > Options... > Services**.
3. Tap **Voice Mail and Text Messages > Get Settings...**

4. Enter the voice mail or text message center number in the appropriate box.
5. Tap **ok**.

If you do not know the correct voice mail or text message phone numbers, contact your mobile phone service provider.

Change network settings

Change phone network settings

In phone network settings, you can:

- View available wireless phone networks.
- Determine the order in which your phone accesses other phone networks (if the current one is unavailable).
- Specify whether you want to change networks manually or automatically.

To change network settings:

1. Tap **Start > Settings > Personal > Phone > Network**.
2. Select the network setting options you want to change.

 **NOTE:** The current phone network your HP iPAQ is using is listed at the top of the screen and remains active until you change it, lose your signal, or change your SIM.

View available phone networks

To view all mobile phone networks available to you:

1. Press the  (Answer/Send) key.
2. Tap **Menu > Options... > Network**.
3. In the **Network selection** list, tap **Manual**.
4. Tap **Find Network** to display all of the available mobile phone networks.
5. Tap **ok**.

Set preferred networks

You can set preferred phone networks in the order you want your HP iPAQ to access them. For example, if your first preferred network is unavailable, your HP iPAQ tries to access your second preferred phone network.

To assign network preferences:

1. Press the  (Answer/Send) key.
2. Tap **Menu > Options... > Network**.
3. Tap **Set Networks** and select your preferred networks.
4. To set the network preference order, tap **Move Up** or **Move Down**.
5. Tap **ok**.

6. In the **Network** screen, tap the **Network selection** list.
7. Tap **Automatic**.

Manually select a phone network

Sometimes you might want to control costs by knowing when connectivity for your current, selected network is unavailable.

To manually select a network:

1. Press the  (Answer/Send) key.
2. Tap **Menu > Options... > Network**.
3. In the **Network selection** list, tap **Manual**.
4. Select the network you want to use and then tap **ok**.
5. If your current network is unavailable, tap **Select**, and then manually select a different network.

Change the ring tone and ring type

Change the ring tone and type to select a different sound to notify you of incoming calls.

To change ring tone and ring type:

1. Press the  (Answer/Send) key.
2. On the screen, tap **Menu > Options... > Phone**.
3. Tap the **Ring type** or **Ring tone** list.
4. Select the sound you want to use.

Take notes during a call

To create a note during a call:

1. On the screen keypad, tap **Menu > Create Note**.
2. Enter your text.

To access a note you created during a call:

1. Press the  (Answer/Send) key > **Call History** on the screen.
2. Tap and hold the name or number for the phone call entry containing the note.
3. Tap **View Note**.

A note created during a call can also be accessed from the **Notes** application. The note title is the phone number you were connected to when writing the note.

Select a frequency band automatically

Your HP iPAQ has an integrated GSM/GPRS/EDGE feature that supports four different frequency bands (850/900/1800/1900) for international roaming. Your HP iPAQ also supports WCDMA/HSDPA in three different frequency bands (850/1900/2100). When traveling between countries and/or wireless network operators, this feature automatically changes the connection settings for frequency bands if the home band is unavailable. This feature is the default setting on the HP iPAQ.

To avoid problems once you are out of the country, follow these tips before you leave:

- Visit your mobile phone service provider's Web site to see if their service is available where you are traveling.
- Verify if your mobile phone account is set up for international roaming and if additional charges apply.

Copy a contact from a SIM to a device

When using the SIM card in multiple devices, you can copy contacts from the SIM to the new device.

1. Tap **Start > Contacts**.
2. Tap **Menu > Copy from SIM**.
3. Tap **ok** to copy the contacts or **Cancel** to go back to the previous screen.
4. Tap **Start > Contacts** and search for the added contacts to verify if you copied the contacts to your HP iPAQ.

Add Tele-typewriter (TTY) functionality

Add TTY functionality for people who are hearing impaired or hard-of-hearing

HP iPAQ products support Tele-typewriter (TTY) functionality, which allows people who are hearing impaired or with hearing limitations to communicate using existing telephony infrastructure, including cell phones. To achieve this, separately purchased TTY devices must be connected to the telephones on both ends of a telephone call session, and the HP iPAQ must be configured for TTY use. The sending TTY device generates a distinct audio tone for every supported character, and these tones are decoded and converted back into text on the receiving TTY device.

Due to the use of audio compression codecs in modern digital cell phones, these TTY audio tones might be unintentionally distorted while being transmitted through cell phones. Therefore, in order for TTY devices to continue to work in cellular networks, the cell phone must be set into a mode that optimizes the compression codec to handle TTY tones instead of the human voice.

To use TTY with the HP iPAQ, an optional TTY audio adapter must be plugged into the HP iPAQ headset connector. This TTY audio adapter converts the pin-out of the headset connector, which is designed for a wired ear bud and stereo headphones, to the pin-out required by most TTY devices. To purchase the TTY audio adapter (part number: FA709BAC3), visit <http://www.hp.com> > **Handhelds & Calculators > Options and Accessories**.

 **NOTE:** Because the HP iPAQ does not support internal Cellular Text Telephone Modem (CTM) conversion, the TTY device you use must contain CTM conversion, or you must use an external CTM adapter between the HP iPAQ and the TTY device.

For information on connecting TTY devices or CTM adapters to the HP iPAQ, refer to the TTY device or CTM adapter manufacturer's documentation.

HP is committed to developing products, services and information that are accessible to everyone, including people with disabilities or age-related limitations. For more information, visit <http://www.hp.com/accessibility>.

Enable TTY support

 **NOTE:** Before enabling TTY support on the HP iPAQ, connect a headset into the headset connector or the setting reverts back to disabled. For example, plug in the optional TTY audio adapter into the ear bud jack first, as described below. Once you enable TTY support, you can remove the headset and TTY remains enabled on the HP iPAQ until you disable it.

To enable TTY support:

1. Connect the TTY device to the TTY audio adapter.
2. Connect the TTY audio adapter to the headset connector on the bottom of the HP iPAQ.
3. Press the **Answer/Send** key on the front of the HP iPAQ to launch the screen keypad.
4. Tap **Menu > Options... > TTY**.
5. Tap **On**.
6. Tap **ok**. The  icon displays in the Navigation bar when it is enabled. Now you are in TTY audio mode.
7. Connect the optional TTY device cable to the TTY audio adapter as stated in the TTY manufacturer's documentation.

 **NOTE:** Do not activate TTY audio mode while a telephone call is already in progress.

Make a phone call using the TTY enabled HP iPAQ

To make a phone call using the TTY enabled HP iPAQ:

1. Press the  (Answer/Send) key.
2. Dial the phone number of the person you are trying to reach who also has a Tele-typewriter (TTY) device connected to his phone. If you are asked if you want to turn on the phone, tap **Yes**.

 **NOTE:** Install a SIM card before making your first phone call.

3. When the phone call is answered, start typing on the TTY keyboard.

The letters typed into the TTY device are turned into electrical signals that travel over regular telephone lines. When the signals reach their destination (another TTY device), they are converted back into letters that appear on a display screen, are printed on paper, or both.

When you are finished typing your phone conversation, the person on the other end of the line might begin typing their answers or comments to you.

4. To end the phone call, press and hold the  (End) key.

 **NOTE:** If a normal headset is connected while TTY support is enabled, the audio quality might decrease. Also, if you make a phone call using a Bluetooth headset while in TTY mode and insert a plug into the headset connector, TTY audio mode activates thereby reducing the quality of voice calls.

Disable TTY support

To disable TTY support:

1. Press the  (Answer/Send) key to launch the screen keypad.
2. Tap **Menu > Options... > TTY**.

3. Tap **Off**.
4. Tap **ok**.

 **NOTE:** If you plan to use the HP iPAQ in both normal and (TTY) audio mode, HP recommends disabling TTY support when the HP iPAQ is not being used for TTY to allow the special network resources to be used by others.

Voice notes

The voice notes application allows the user to record audio notes. You can create a stand-alone recording, which is recording a note without actually writing it, or you can add a recording to a note.

Create voice notes

You can create stand-alone recording (voice note) or add a recording to a note using the notes application.

To create a stand-alone recording (voice note):

1. Tap **Start > Programs > Notes**.
2. From the note list, tap the  (Record) button.

 **NOTE:** If the Recording toolbar does not appear, tap **Menu > View Recording Toolbar**.

3. Speak into the microphone located at the bottom of the unit.
4. When you have finished recording the note, tap the  (Stop) button on the recording toolbar.

To add a recording to a note:

1. Tap **Start > Programs > Notes**.
2. Create or open a note, and then tap the  (Record) button.

 **NOTE:** If the Recording toolbar does not appear, tap **Menu > View Recording Toolbar**.

3. Speak into the microphone located at the bottom of the unit.
4. When you have finished recording the note, tap the  (Stop) button on the recording toolbar.

 **NOTE:** If you are recording in an open note, an icon displays in the note. If you are creating a stand-alone recording, an icon is displayed next to the note in the note list.

Also, you can create a voice note in **HP Photosmart Mobile** and attach the note to a picture.

Delete voice notes

To delete a stand-alone recording voice note:

1. Tap **Start > Programs > Notes**.
2. From the note list, tap and hold the note.
3. Tap **Delete**.

To delete a recording within a note:

1. Tap **Start > Programs > Notes**.
2. Open a note.
3. Tap and hold the  (Voice Note) icon.
4. Tap **Clear**.

Listen to voice notes

To listen to voice notes:

1. Tap **Start > Programs > Notes**.
2. Tap the  (Recorded voice note) icon to hear the note.

Rename voice notes

To rename voice notes:

1. Tap **Start > Programs > Notes**.
2. Tap and hold the note to rename.
3. Tap **Rename/Move**.
4. Enter the new name in the **Name** box.
5. Tap **ok**.

Configure channels

Enable this feature to receive real-time news and information such as traffic news and weather reports. Check with your mobile phone service provider for availability in your area.

To configure the phone broadcast channels:

1. Tap **Start > Settings > Personal > Phone > More**.
2. Select the **Cell Broadcast** check box.
3. Tap **Setting...**
4. Tap **Add...**, and then enter the channel name and number.
5. Tap **ok**.

Notes

You can store information in the form of notes on your HP iPAQ.

Write a note

To write a note:

1. Tap **Start > Programs > Notes**.



NOTE: Writing must be selected as the default input mode.

2. Tap **New**.
3. Write your text on the screen.
4. When finished, tap **ok** to return to the note list.

To select handwritten text, tap and hold next to the writing. As soon as dots appear and before they form a complete circle, quickly drag across the writing.

If a letter crosses three ruled lines, it is treated as a drawing rather than text.

Create a copy of a note

To create a copy of a note:

1. Tap **Start > Programs > Notes**.
2. Tap the note you want to copy.
3. Select the text on the screen, tap **Menu > Copy**.
4. Open the required note from the note list or a new note to which the selected content is to be copied.
5. Tap **Menu > Paste**.

If you paste the contents in a new note, a copy of the note displays in the note list.

7 Camera

With the built-in 3 megapixel camera, you can record video clips and take pictures, and view and save them on your HP iPAQ.

 **NOTE:** The camera is not available on all models.

Use the camera

Use the built-in camera on your HP iPAQ to capture and view photos.

Capture photos

You can capture photos and store them in your HP iPAQ or storage card.

 **NOTE:** You cannot use the camera if the battery power is less than 20%.

To capture photos:

1. Press the **Camera** key or tap **Start > Programs > Camera**.
2. Press 6 on the keypad to zoom in and 4 on the keypad to zoom out.

 **NOTE:** You will not be able to use these keys to zoom in or out when the camera is used with 3M resolution.

3. Press 8 on the keypad to increase brightness and 2 on the keypad to decrease brightness.
4. Press the **Camera** key to capture a photo and automatically save it in **File Explorer > My Documents > My Pictures**.

 **NOTE:** Tap the  (Flash) button to enable flash while taking pictures.

View photos

To view photos captured on your HP iPAQ:

1. Tap **Start > HP Photosmart Mobile**.
2. Navigate to a required folder.
3. Tap the folder to open it and tap the required photo.

Camera settings

To set up the camera settings, tap **Start > Programs > Camera**. Tap the  (Settings) button.

Basic settings

You can set basic options for the camera. The settings on the **Basic** tab can be applied while taking photos and also while recording video clips.



- **Enable Shutter Sound** – Select this option to enable the shutter sound while clicking photos.
- **Photo File Prefix** – Specify a prefix name for the photos you click.
- **Video File Prefix** – Specify a prefix name for the video clips you record.
- **Save file to** – Specify a location on your HP iPAQ where you want to store your images and videos.

You can use additional features, such as **White Balance**, **Effect**, **Contrast**, **Brightness**, **Hue**, **Saturation**, **Flicker**, and **Sharpness**, to enhance the appearance of your photos or videos.

Photo settings

Tap the **Photo** tab, to configure the required settings for capturing photos.

- **Capture Mode** – Enables you to change the mode for capturing photos.
 - **Normal** – Align the focus rectangle with your object and press the **Camera** key located on the right-hand side of your HP iPAQ. When the focus rectangle turns green, press the **Camera** key again to capture the photo.

 **NOTE:** This is the default mode for capturing photos.
 - **Timer** – Use this mode to capture self portraits. After you press the **Camera** key, a time delay of 10 seconds will be displayed in the focus rectangle.
 - **Burst** – Use this mode to capture a set of 5 photos by pressing and holding the **Camera** key.
 - **Panorama horizontal** – Use this mode to create horizontal panoramic images, such as vast landscapes and city skylines. Press the **Camera** key to shoot the leftmost photo first. When shooting the next photo, 1/3 of the previous photo is displayed on the left side of the screen. This helps match the previous photo when capturing the next photo. After capturing all photos, tap  to stitch them.
 - **Panorama vertical** – Use this mode to create vertical panoramic images, such as monuments and tall structures. Press the **Camera** key to shoot the top photo first. When shooting the next photo, 1/3 of the previous photo is displayed on the top of the screen. This helps match the previous photo when capturing the next photo. After capturing all photos, tap  to stitch them.
- **Resolution** – Select a resolution for your photos from the available options: **QVGA – 320 X 240**, **VGA – 640 X 480**, **1M – 1280 X 960**, **1.3M – 1280 X 1024**, **2M – 1600 X 1200**, and **3M – 2048 X 1536**.
- **Photo Quality**: Select the quality of the photo as **Low**, **Normal**, or **High**.

Video recorder

Record videos

You can use the built-in camcorder on your HP iPAQ to create short videos and share them with your friends and family.

To record videos:

1. Tap **Start > Programs > Camera**.
2. Tap  (Video) button to go into the video mode.
3. Press the **Camera** key to start recording. Press the **Camera** key again to stop recording.

Configure video format

Tap **Start > Programs > Camera**, and then tap the  (Settings) button.

- On the **Video** tab, change one of the following:
- Select resolution from the **Resolution** list. You can change the settings to:
 - QCIF(176 X 144)
 - QVGA(320 X 240)









 **NOTE:** Select the **Record voice** check box to record voice while recording videos.









Video settings

Tap the **Video** tab to configure the required settings for recording videos.

- **Video Format** – Select the video format.
- **Resolution** – Select a resolution for your videos from the available options: **QCIF(176 X 144)** or **QVGA(320 X 240)**
- **Record Voice** – Select this check box to record audio along with the video.
- **Fit to MMS** – Select this check box to ensure that the recorded video does not exceed the file size that an MMS can hold.

Options for camera and video recorder

	Device – This icon displays the number on the left top corner of the screen that indicates how many photos you can save to the current storage device.
	Flash off – Tap to turn the flash on
	Flash on — Tap to turn the flash off
	Resolution – Tap to change the resolution
	Exit – Tap to exit the application
	HP Photosmart Mobile – Tap to launch HP Photosmart Mobile to view the captured photos
	Video – Tap to switch to the camera mode
	Settings – Tap to change the settings
	Focus – Press the numeric key 4 or 6 to zoom out or zoom in.

	NOTE: You need to tap the screen while capturing photos to view the Focus slider.
	NOTE: You will not be able to use these keys to zoom in or out when the camera is used with 3M resolution.
	Brightness – Press numeric key “2” or “8” to adjust the brightness.
	NOTE: You need to tap the screen while capturing photos to view the Brightness slider.
	Panorama – This icon is displayed while capturing panorama photos.
	Stitch – Tap to stitch the photo into a panorama after capturing a set of photos in the Panorama modes.
	Photo – Tap to return to the capture mode and capture new photos.
	Send As – Tap this icon to select an account and e-mail captured photos.
	Delete – Tap to delete the current photo.
	HP Photosmart Mobile – Tap to launch HP Photosmart Mobile and view the captured photos.
	Play – Tap to play current video clips.
	You can Stop , Pause , or Play the video by tapping on the control icons. The time bar shows the playback progress.

Transfer images

Use GPRS

When the phone radio is turned on for the first time, the **HP iPAQ DataConnect** application detects the mobile phone service provider and automatically populates the MMS settings on the HP iPAQ.

 **NOTE:** You need a data-enabled SIM installed in your HP iPAQ.

To transfer pictures using MMS:

1. Press the left softkey on the **Today** screen > **MMS**.
2. Tap **Menu** > **New**.
3. Tap the picture or the video you want to attach.
4. Tap **Send**.

Use Bluetooth

You can do the following to transfer images from your HP iPAQ to other devices:

To transfer images using Bluetooth:

1. Tap **Start** > **HP Photosmart Mobile**.
2. Scroll and select a picture.
3. Tap **Menu** > **Beam picture...** Select the device and tap **Tap to send**.

 **NOTE:** You should have the Bluetooth connection on to transfer images.

8 HP Photosmart Mobile

You can use HP Photosmart Mobile to:

- View pictures stored on your HP iPAQ or a storage card.
- Add voice or text notes to pictures.
- Print using Storage Card.
- View a slideshow.
- Send pictures via MMS, e-mail attachments, or Bluetooth.
- Associate a picture with a contact.
- Assign a picture to the **Today** screen background.
- Upload an image via e-mail to Snapfish.

View pictures stored on your HP iPAQ or a storage card





You can view photos stored on your HP iPAQ or an external storage card using the HP Photosmart Mobile.

To view photos:

1. Tap **Start > HP Photosmart Mobile**.
2. Tap **Menu > Open Folder**.
3. Browse to the folder where you have saved the photos.
4. Tap **ok**.

Attach a voice note to a picture

To attach a voice note to a picture:

1. Tap **Start > HP Photosmart Mobile**.
2. Tap the thumbnail to which you want to add a voice note.
3. Tap the  (Sound) button.
4. Tap the  (Record) button on the sound toolbar.
5. Speak into the microphone to record the voice note and tap the  (Stop) button when finished.
6. To delete the recorded voice note, tap .
7. Tap the  (Sound) button again to close the sound toolbar.

Print using Storage Card

 **NOTE:** All printers do not support printing from a storage card.

To print pictures using storage card:

1. Tap **Start > HP Photosmart Mobile**.
2. Tap the thumbnail of the image to be printed.

 **NOTE:** If the media file is protected by Digital Rights Management (DRM), you would not be able to send or forward it. DRM is a software that enables secure distribution and prevents illegal distribution of pictures, videos, music, movies, and ring tones over the Internet. For more information on DRM, refer to the on-screen help by tapping **Start > Help** and search for DRM.

3. Tap **Menu > Print...**

 **NOTE:** All printers do not support printing from a storage card.





4. Select the number of copies you want to print and tap **Save**

You can now print the photos saved on the storage card.

 **NOTE:** You need to set up the printer before you begin printing photos from a storage card. Setup instructions vary from printer to printer.

View a slideshow

To view a slideshow:

1. Tap **Start > HP Photosmart Mobile**.
2. Tap the  (Slideshow) button at the bottom of the screen.
3. Tap the screen to view the  (Forward),  (Backward),  (Stop), and  (Pause) buttons.

E-mail pictures

 **NOTE:** You need to configure your e-mail messaging account to send pictures using e-mail.

To send pictures through e-mail:

1. Tap **Start > HP Photosmart Mobile**.
2. Tap the thumbnail to be sent via e-mail.

 **NOTE:** If the media file is protected by Digital Rights Management (DRM), you would not be able to send or forward it. DRM is a software that enables secure distribution and prevents illegal distribution of pictures, videos, music, movies, and ring tones over the Internet. For more information on DRM, refer to the on-screen help by tapping **Start > Help** and search for DRM.

3. Tap **Menu > Send... > E-mail Attachment**.
4. Select the **Reduce sent photo size to** check box, and then select the reduction in resolution.
5. Tap **Next**.
6. Enter the appropriate e-mail address or use **Contacts** by tapping **Menu > Add Recipient**.

7. Enter other appropriate information, such as an e-mail title and message.
8. Tap **Send**.

Associate a picture with a contact

To associate a picture with a contact:

1. Tap **Start > HP Photosmart Mobile**.
2. Tap the thumbnail you want to associate with a contact.
3. Tap **Menu > Assign To > Contact**.
4. Tap the name from the contact list.
5. Tap **ok**.

Assign a picture to the Today screen background

To assign a picture to the Today screen background:

1. Tap **Start > HP Photosmart Mobile**.
2. Tap the thumbnail you want to assign to the **Today** screen.
3. Tap **Menu > Assign To > Today Background**.
4. Tap **ok**.

Snapfish

Snapfish feature enables you to upload images from your HP iPAQ to your **Snapfish** account via your e-mail account.

1. Tap **Start > HP Photosmart Mobile**.
2. Tap the thumbnail to be sent via **Snapfish**.
3. Tap **Menu > Send... > Snapfish**.
4. Select the **Reduce sent photo size to** check box, and then select the required reduction in resolution.
5. Tap **Next**.
6. Select the appropriate e-mail account in the **Select e-mail account** list and tap **Send**.

 **NOTE:** To get more information about **Snapfish** feature, tap **Help**.

 **NOTE:** If the e-mail account used to send the photo to **Snapfish** is not registered, you will receive an e-mail with a link to a Web page that allows you to register an account.

Enhance documents

The document enhancement feature enables you to process an image of a document taken with a camera, such as photos of a business card, magazine, or newspaper, to produce scanner-like results.

To use the document enhancement feature:

1. Tap **Start > HP Photosmart Mobile**
2. Tap **Menu > Tools > Enhance Document**.
3. Select one or both of the following options:
 - **Straighten and crop** – To detect the edges of a document and crop the original document to a rectangular shape.
4. Tap **Start** to begin document processing.

 **NOTE:** The document enhancement feature processes only JPEG images.

Set the screen saver

Use your HP iPAQ to set a slideshow of your images as the screen.

To set the screen saver:

1. Tap **Start > HP Photosmart Mobile**
2. Tap **Menu > Tools > Screen Saver**.
3. Tap **Show Screen Saver** check box and specify the duration after which you want to activate the screen saver from the **Launch Screen Saver after** list
4. Tap the **Effects** tab, and select the **Use transition effects** check box to choose a transition effect.
5. Tap the **Date/Time** tab to select the date and time display option.

 **NOTE:** **HP Photosmart Mobile** automatically displays the slideshow you selected, if your device is inactive while it is connected to the computer with the synchronization software running.

Switch to camera application

You can switch to the camera application from the HP Photosmart application.

To switch to the camera application:

1. Tap **Start > HP Photosmart Mobile**
2. Tap **Menu > Switch to Camera**.

 **TIP:** You can also tap the  (Capture) icon to switch to the camera application

Organize images

Use your HP iPAQ to manage or organize a set of images by moving, copying or deleting a single image or a set of images.

To organize your images:

1. Tap **Start > HP Photosmart Mobile**
2. Tap **Menu > Organize**.
3. Tap the images you want to organize or tap **Menu > Select > All** to select all the images.
4. Tap **Menu > Move/Copy** for options of moving or copying the selected images to card or another folder on your HP iPAQ.
5. To select a range of images, tap **Menu > Select > Range**. Next, tap the first image and then tap the last image
6. To delete the selected files, tap **Menu > Delete**.

Send an image to clipboard

You can copy an image to the clipboard to use it in other applications.

To copy an image to clipboard:

1. Tap **Start > HP Photosmart Mobile**
2. Tap and hold an image thumbnail.
3. Tap **Move/Copy > Copy to Clipboard** from the menu and choose the appropriate scaling size.

Video support

You can play videos using the HP Photosmart application.

To play videos:

1. Tap **Start > HP Photosmart Mobile**
2. Select the video thumbnail and tap **View**.

9 Storage cards

Use storage cards

Use optional storage cards for:

- Expanding the memory of your HP iPAQ
- Storing pictures, video clips, music, and applications

 **NOTE:** Storage cards are not included with your HP iPAQ, and must be purchased separately.

For more information about storage cards, visit <http://www.hp.com/go/ipaqaccessories>.

Insert a storage card

To insert a storage card:

1. Press and hold the **Power** key to turn off your HP iPAQ.
2. Remove the battery cover, slide the storage slot cover back and lift it.

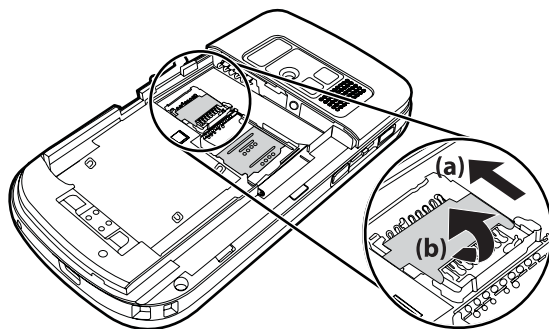

3. Place the card in the storage card holder with the metal area inserted first.
4. Slide back the storage card holder until it fits into place.

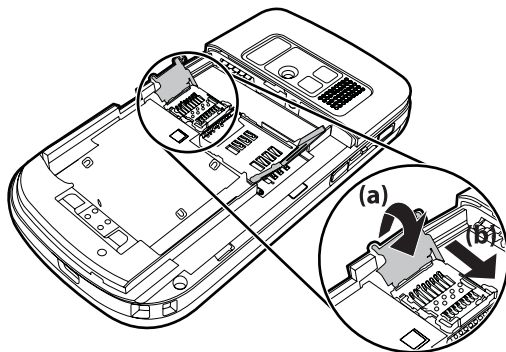

If you have trouble inserting a storage card, try the following:

- Make sure you are not inserting the card at an angle.
- Make sure you insert the connection area (the metal area) first.

Remove a storage card

To remove a micro Secure Digital (SD) storage card from the storage slot on the HP iPAQ:

1. Close all programs that are using the storage card.
2. Press and hold the **Power** key to turn off your HP iPAQ.
3. Remove the battery.
4. Slide the storage slot cover back and lift it.

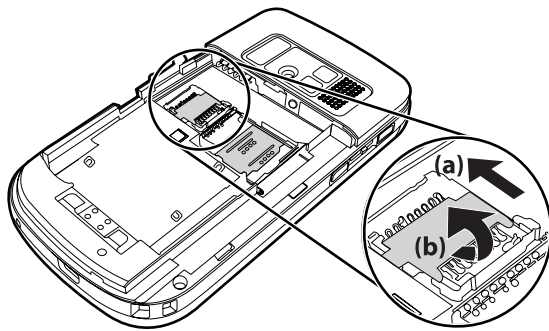

5. Remove the storage card from the storage card slot.

View contents of a storage card

Use File Explorer to view the files that are located on your optional storage card.

To view contents of a storage card:

1. Tap **Start > Programs > File Explorer**.
2. Tap **Up**, then select the storage card folder to see a list of files and folders.

If the HP iPAQ does not recognize your storage card, try the following:

- Make sure to install any drivers that came with the storage card.
- Reset the HP iPAQ by using the stylus to lightly press the **Reset** button.

 **NOTE:** Make sure that you save your data on the storage card before you reset.

10 Synchronization

Synchronization software

If your computer is running Windows XP or an earlier version, synchronization settings are managed through Microsoft ActiveSync. Microsoft ActiveSync 4.5 is available on the *Getting Started* CD. You can also visit <http://www.microsoft.com/windowsmobile> for more information or to download Microsoft ActiveSync.

If your computer is running Windows Vista, synchronization settings are managed through Windows Mobile Device Center (WMDC). WMDC 6.1 is available on the *Getting Started* CD. You can also visit <http://www.microsoft.com/windowsmobile> to download WMDC.

Copy files

You can copy files to and from the computer using ActiveSync.

To configure your HP iPAQ using the Pocket PC sync setup wizard:

1. Connect your HP iPAQ to the computer using the mini-USB synchronization cable and wait for the synchronization software to launch (WMDC for Windows Vista and ActiveSync for Windows XP).
2. Tap **Next** after the Pocket PC sync setup wizard is displayed.
3. You can select one of the following options:
 - Select the **Synchronize directly with a server running Microsoft Exchange. To do this now, you will need to have the server address and your logon credentials** check box and tap **Next**. Enter the required information on the screen if you want to configure your e-mail account using the Exchange Server.
 - If you want to sync your HP iPAQ to the Outlook e-mail account on your computer, clear the **Synchronize directly with a server running Microsoft Exchange. To do this now, you will need to have the server address and your logon credentials** check box and then tap **Next**.
4. Select the item you want to synchronize from the **Information Type** list and select either **Windows PC (This PC)** or **Microsoft Exchange** from the **Source** list.
5. Tap **Next**, and then tap **Finish** to complete the setup.

To copy files using ActiveSync without using the Pocket PC sync setup wizard:

1. Connect your HP iPAQ to the computer using the mini-USB synchronization cable and wait for the synchronization software to launch (WMDC for Windows Vista and ActiveSync for Windows XP).
2. After the Pocket PC sync setup wizard launches, tap **Cancel** to continue copying files without using the wizard.
3. On the computer, select **Start > Programs > Microsoft ActiveSync**.
4. In the **ActiveSync** window, select **Explore**.
5. Double-click **My Windows Mobile-Based Device** and select the files to be copied or copied to from your computer.

6. Open **Windows Explorer** on your computer and locate the files to be copied or copied to from your HP iPAQ.
7. Drag and drop the files between your HP iPAQ and the computer. ActiveSync converts the files so that they can be used by the Office Mobile programs, if necessary.

 **NOTE:** You cannot copy preinstalled files or system files.

To copy files using WMDC:

1. Connect your HP iPAQ to the computer and wait for WMDC to launch automatically.
2. Click **File Management** to open the Mobile Device folder for your device.
3. In the **Mobile Device** folder, navigate and select the file that you want to copy on your device or computer.

Move the files directly into My Documents on your HP iPAQ (or into a folder inside My Documents).

Migrate data from Palm Desktop to Microsoft Windows Mobile 6

If you used a Palm OS based device before purchasing your HP iPAQ, you need to migrate your data from the Palm Desktop software to Microsoft Windows Mobile 6.

To migrate data from Palm Desktop to Windows Mobile 6:

1. Ensure that you have Microsoft Outlook 98 or higher installed on your computer.
2. To switch synchronization from the Palm Desktop to Outlook, insert the original CD that came with your Palm device into your computer's CD ROM drive. From the **Discover Your Handheld** screen, select **Install Microsoft Outlook Conduits**. Alternatively, you can reinstall the Palm Desktop and HotSynch Manager software from the original CD. During the configuration process, select **I want to sync with Microsoft Outlook**.

 **NOTE:** Microsoft Outlook must be set as your default e-mail program to properly synchronize with the Palm Desktop software. If you need to change your settings, open Microsoft Outlook, then click **Tools > Options > Other** tab and check the **Make Outlook the default program for E-mail, Contacts, and Calendar** check box. Click **Apply > OK**, and then restart your computer.

3. Use the HotSynch Manager software located on the original CD that came with your Palm device to synchronize your Palm information with Outlook. Refer to the instructions that came with your Palm device for help installing or using HotSynch.
4. When Outlook is synchronized with your Palm device, uninstall Hotsynch from your computer. Click **Start > Control Panel > double-click Add or Remove Programs**. Select **Palm Desktop**, then click **Remove**. Follow the on-screen instructions.
5. Insert the *Getting Started* CD into your computer's CD-ROM drive and follow the on-screen instructions to install ActiveSync on your computer and create a partnership between your HP iPAQ and your computer.

Wireless synchronization cost saving tips

How you manage the cost of synchronizing without wires from your HP iPAQ depends on your priorities.

To	Do this
----	---------

Reduce network connection or data transfer costs	Increase the time between scheduled synchronizations, or synchronize manually. Check the details of your rate plan.
Extend battery life	Schedule synchronization less frequently or synchronize manually.
Keep your information up to date	During periods of high mail volume, schedule synchronization at regular but frequent intervals. During periods of low mail volume, schedule synchronization as items arrive.

 **NOTE:** The device power-down timer is reset each time you synchronize. If you schedule a synchronization interval that is smaller than the time interval set for the device to automatically power down, the device never turns off to save battery power.

Troubleshoot synchronization issues

Following is a list of symptoms that might indicate synchronization issues for Windows Vista:

- WMDC does not launch even after installation.

Following is a list of symptoms that might indicate synchronization issues for Windows XP:

- No **ActiveSync** tone plays (or a gray icon displays), and there is no activity in the **ActiveSync** window on your computer.
- **ActiveSync** tone plays, and the **ActiveSync** icon on your computer changes to a swirling green icon. The **Retrieving settings** message displays on your computer, but the **ActiveSync** connection drops prior to establishing the partnership.
- **ActiveSync** is searching for a connection but cannot establish one. (The green icon on your computer continues to spin.)
- Synchronization has been established between your HP iPAQ and computer but connection is dropped. (The green icon on your computer stops spinning and grays out.)
- Firewall or other network protection software message box is displayed for **ActiveSync** to access the network or Internet.

Following is a list of troubleshooting tips if you experience difficulty while synchronizing your HP iPAQ and computer. Try the following solutions to troubleshoot any synchronization issues:

- Check the OS on your computer before you begin synchronizing information between your HP iPAQ and computer. The synchronization method varies depending on the OS running on the computer.

If your computer is running Windows XP or an earlier version, synchronization settings are managed through Microsoft ActiveSync. Microsoft ActiveSync 4.5 is available on the *Getting Started* CD. Visit <http://www.microsoft.com/windowsmobile> for more information or to download Microsoft ActiveSync.

If your computer is running Windows Vista, synchronization settings are managed through Windows Mobile Device Center. Visit <http://www.microsoft.com/windowsmobile> to download Windows Mobile Device Center.

 **NOTE:** HP does not guarantee the accurate functionality of any third party applications with Windows Vista.

- If you are running **ActiveSync 4.5** or later and personal firewall software on your computer, please add **ActiveSync** to the firewall program's exception list.

(Firewall software, such as Sygate Personal Firewall, TrendMicro PC-cillin Internet Security 2005, Norton Personal Firewall, McAfee Personal Firewall, or Zone Alarm Security Suite might block synchronization.) Refer to the documentation that came with your firewall program to determine how to add ActiveSync 4.5 or later to the program's exception list. To further troubleshoot a firewall application and enable ActiveSync 4.5 or later, visit: <http://www.microsoft.com/windowsmobile>.

- During the **ActiveSync** installation, if you inadvertently left the **Microsoft Exchange Server** option box checked and are not planning to connect to an Exchange Server, follow these steps:
 - Connect your HP iPAQ to your computer. Make sure an **ActiveSync** connection is established.
 - On your computer, click **Start > All Programs > Microsoft ActiveSync**.
 - Click **Tools > Options**.
 - Clear the boxes for the sync items listed under the **Server group**.
 - Select the check boxes under the **Computer group** for those items you want to synchronize.
- Disconnect your HP iPAQ from your computer and wait for the **ActiveSync** message confirming that your device is no longer connected. Reconnect your HP iPAQ to your computer. Wait to see if your HP iPAQ connects to your computer.
- On your computer, in **ActiveSync** application, select **File > Connection Settings**. Confirm that USB is selected as a potential connection method.
- Connect your HP iPAQ to a different USB port on your computer.
- Check your mini-USB synchronization cable. Consider using another mini-USB synchronization cable if one is available to you.
- Try synchronizing via a Bluetooth connection. Refer to the printed or CD-based documentation that came with your HP iPAQ for specific instructions.
- Unplug your HP iPAQ from your computer, and then connect back.
- Uninstall **ActiveSync** from your computer and then reinstall it. To uninstall **ActiveSync** from your computer, click **Start > Control Panel > Add or Remove Programs > Microsoft ActiveSync**. Then click **Remove > Yes**.

After trying the above solutions if you still do not have any success in solving your connection problem, perform a hard reset on your HP iPAQ using the HP iPAQ Setup Assistant.

You can reinstall your applications on your HP iPAQ after the hard or clean reset is complete by using ActiveSync on your computer. After your HP iPAQ is synchronized properly, go to **ActiveSync** on your computer and select **Tools > Add/Remove Programs**, and then select any programs you want to reinstall.

Customized links in WMDC

After connecting your device to a Windows Vista system using WMDC 6.1, an image of HP iPAQ 600 Series Business Navigator pops up on the left of the **Windows Mobile Device Center** screen. You can set up your device to synchronize the Outlook contacts, e-mail, and other information on your device or just connect the device by skipping the setup process.

After the device synchronizes with your computer, the following links are displayed on your computer:

- **Programs and Services**
- **Pictures, Music, and Video**
- **File Management**
- **Mobile Device Settings**

To view a list of customized links, navigate to **Programs and Services**. Click **more>>** to view additional links for the various HP services and click **<<back** to go back to the previous screen.

11 Tasks

Set start and due dates for a task

To set dates for a task:

1. Tap **Start > Programs > Tasks**.
2. Tap the task you want to set start and due dates for.
3. Tap **Edit** and do one or both of the following:
 - Tap **Starts** to enter a start date for the task.
 - Tap **Due** to enter a due date for the task.
4. Tap **ok**.

Show start and due dates in the task list

To enable display of dates for a task in the task list:

1. Tap **Start > Programs > Tasks**.
2. Tap **Menu > Options...**
3. Select the **Show start and due dates** check box.
4. Tap **ok**.

Set options for displaying tasks on the Today screen

If you have a large number of tasks, you might want to specify the kind of tasks that are displayed on the **Today** screen.

To enable display of tasks on the **Today** screen:

1. Tap **Start > Settings > Personal > Today**.
2. Tap **Items**, and then select the **Tasks** check box.
3. Tap **Tasks** to access options, then tap **Options...**
4. Under **Display number of**, select the type of tasks to appear on the **Today** screen.
5. In the **Category** list, select whether to display only tasks assigned to a specific category only if categories have been assigned or to display all tasks.

Mark a task as completed

To mark a task as completed:

1. Tap **Start > Programs > Tasks**.
2. In the task list, select the check box next to the task you want to mark as completed.

To mark an open task as completed:

1. Tap **Edit**.
2. In the **Status** box, tap **Completed**.

12 Messaging

Understand messages

To send and receive e-mail messages for an e-mail account, you need to connect to the Internet or your corporate network, depending on the account.

You can send and receive:

- Outlook e-mail
- Internet e-mail through an Internet Service Provider (ISP)
- Text messages

You can also access e-mail from work using a VPN connection. For more information, see [Set up a VPN server connection on page 82](#)

E-mail in the Outlook e-mail account is sent and received through synchronization with a computer using any synchronizing software or through wireless synchronization directly with an Exchange Server.

Internet e-mail is sent and received by connecting to a Post Office Protocol 3 (POP3) or Internet Message Access Protocol 4 (IMAP4) e-mail server. When connecting to a POP3 or IMAP4 server, you will need to get internet connectivity, from the carrier GSM, GPRS, EDGE or a 3G connectivity. Also connectivity can be using Wi-Fi Wireless, Peer-to-Peer with a PC or Bluetooth to an internet connected device. You can also use your HP iPAQ to connect by using a data capable cell phone.

Text messages are sent and received through your wireless service provider using a phone number as the message address.

Folder types

Each messaging account has its own set of folders with five default Messaging folders:

- **Inbox**
- **Outbox**
- **Deleted Items**
- **Drafts**
- **Sent Items**

The messages you receive and send through the account are stored in these folders. You can also create additional folders for each account.

The way folders work vary by type:

- If you use an Outlook e-mail account, e-mail messages in the Inbox folder in Outlook are synchronized automatically with your device. You can select additional folders for synchronization by assigning them designations. The folders you create and the messages you move are then mirrored on the e-mail server.
- If you use an MMS account or a text message account, messages are stored in the Inbox folder.

- If you use a POP3 account and move your e-mail messages to a folder you created, the link between the messages on the device and their copies on the e-mail server breaks. When you connect, the e-mail server detects that the messages are missing from the Inbox folder on the device and deletes them from the e-mail server. This prevents having duplicate copies of a message, but it also means that you no longer have access to messages.
- If you use an IMAP4 account, the folders you create and the e-mail messages you move are mirrored on the e-mail server. These messages are therefore available from any location or device. This synchronization of folders occurs whenever you connect to your e-mail server, create new folders, or rename/delete folders when connected. You can also set different download options for each folder.

Synchronize e-mail

When you synchronize Outlook e-mail on the computer with your device, e-mail messages are synchronized as follows:

- Messages in the Inbox folder on your computer or Exchange Server are copied to the Inbox folder of the Outlook e-mail account on your device.
- Messages in the Outbox folder on your device are transferred to Exchange Server or Outlook and then sent from those programs.
- When you delete a message on your device, it is deleted from your computer or Exchange Server the next time you synchronize.
- The default sync settings synchronize messages from the past three days and the first 0.5 KB of each new message is downloaded. It does not download file attachments.

 **NOTE:** For more information on starting Outlook e-mail synchronization or changing synchronization settings, see ActiveSync Help on the computer.

Text messages are not received via synchronization. Instead, they are sent to your device via your service provider.

Set up messaging accounts

Set up e-mail using Exchange Server

To set up e-mail using Exchange Server:

1. Press the left softkey > **New E-mail Account**.
2. Enter your e-mail address in the **E-mail address** box, and then tap **Next**.
3. Clear the **Try to get e-mail settings automatically from the Internet** check box.

 **NOTE:** Ensure that you clear the **Try to get e-mail settings automatically from the Internet** check box only when you manually configure your e-mail.

4. Scroll and select the **Exchange Server** option from the **Your e-mail provider** list.
5. Tap **Next** to synchronize outlook with your organization's Exchange e-mail server.
6. In **Server address**, enter the Outlook Web Access server address and tap **Next**.

 **NOTE:** Select **This server requires an encrypted (SSL) connection** check box to ensure you always send e-mail from this account using an SSL connection.

7. Enter the **User name**, **Password**, and **Domain** on the **Edit Server Settings** screen.
8. Select the check box for the items you want to synchronize, and tap **Finish**.

Internet e-mail

Create a new POP3 or IMAP4 account

You must set up an e-mail account that you have with an ISP or an account that you access using a VPN server connection (typically a work account) before you can send and receive e-mail.

To create a new POP3 or IMAP4 account:

1. Press the left softkey > **New E-mail Account**.
2. Enter the account name and then Tap **Next**.
3. Clear the **Try to get e-mail settings automatically from the Internet** check box.

 **NOTE:** Ensure that you clear the **Try to get e-mail settings automatically from the Internet** check box only when you manually configure your e-mail.

4. Scroll and select the **Internet e-mail** option from the **Your e-mail provider** list and tap **Next**.
5. Enter your name and required account name and tap **Next**.
6. Enter the incoming server name and select the required account type, **POP3** or **IMAP4**.

You can also perform the following functions:

- Change the time intervals for downloading new messages.
- Download attachments.
- Limit the number of messages that are downloaded.

Setting	Description
User name	Enter the user name assigned to you by your ISP or network administrator. This is often the first part of your e-mail address, which appears before the at sign (@).
Password	Choose a strong password. You have the option to save your password so that you do not need to enter it each time you connect to your e-mail server.
Domain	Not required for an account with an ISP. Might be required for a work account.
Account type	Select POP3 or IMAP4.
Account name	Enter a unique name for the account, such as Work or Home. This name cannot be changed later.
Incoming mail	Enter the name of your e-mail server (POP3 or IMAP4).
Outgoing mail	Enter the name of your outgoing e-mail server (SMTP).
Require SSL connection	Select this to ensure you always send e-mail from this account using an SSL connection. This enables you to send personal information more securely. Note that if you select this and your ISP does not support an SSL connection, you might not be able to send e-mail.

Setting	Description
Outgoing mail requires authentication	Select this if your outgoing e-mail server (SMTP) requires authentication. Your user name and password from above is used.
Use separate settings	Select this if your outgoing e-mail server requires a different user name and password than the ones you entered before.
Outgoing server settings	
User name	Enter your user name for the outgoing e-mail server.
Password	Enter your password for the outgoing e-mail server.
Domain	Enter the domain of the outgoing e-mail server.
Require SSL for outgoing mail	Select this to ensure you always send e-mail from this account using an SSL connection. This enables you to send personal information more securely. Note that if you select this and your ISP does not support an SSL connection, you might not be able to send e-mail.

 **TIP:** You can set up several e-mail accounts in addition to your Outlook e-mail account. You cannot add a new account while connected. Tap **Menu > Stop Send/Receive** to disconnect.

Change e-mail download options

You can customize the following download options for each e-mail account that you have with an ISP, or any account that you access using a VPN server connection (typically a work account).

You can choose:

- Whether messages are downloaded automatically.
- How much e-mail is downloaded.
- If and how attachments are downloaded (IMAP4 only).

To change the e-mail download options for POP3 or IMAP4 e-mail account:

1. Press the left softkey > **Menu > Options**.
2. Tap and select the e-mail account.
3. Tap **Next** until you reach **Server information**.
4. Tap **Options**.
5. Enter your changes on the next three screens, and tap **Finish**.

To change the e-mail download options for Outlook e-mail account:

1. Press the left softkey > **Menu > Options**.
2. Tap and select **Outlook E-mail** account.
3. Select the required option, such as 1 day, 3 days, 1 week, or 1 month, from the **Download the past list**.
4. Select the size of the e-mail you want to download from your Outlook account from the **Download size limit list**.

 **TIP:** To send and receive messages automatically, tap **Connect**, check for messages and enter a time interval. Connecting automatically might result in higher connection charges.

To save memory, limit the number of e-mails downloaded to your device by lowering the number of days to display.

To change data you want to sync for an Outlook account, tap **Start > Programs > ActiveSync > Menu > Options**.

Delete an account

To delete an account:

1. Press the left softkey to open the messaging application.
2. Tap **Menu > Options**.
3. Tap and hold the account name, and tap **Delete**.

 **NOTE:** You cannot delete your text message, Outlook E-mail, Windows Live, and MMS accounts.

Text messaging

Text messaging is the transmission of short text messages to and from a mobile phone, fax machine, and/or IP address. A single text message cannot be longer than 160 alpha-numeric characters or cannot contain pictures or graphics.

 **NOTE:** The number of characters supported is dependant on your service provider.

Sending text messages might incur extra costs which may vary depending on your service provider.

Messages longer than 160 alpha-numeric characters are sent as multiple text messages. A character count is visible when text messages (New/Reply/Forward) are composed. The count also shows how many text messages are generated when the message is sent.

The Text Message Service Center phone number is provided by your mobile phone service provider. Text messaging should function correctly after activating your account. To verify the number used to change the Text Message Service Center phone number, press  (Answer/Send) key > **Menu > Options... > Services > Voice Mail and Text Messages > Get Settings...**

MMS

MMS is a method of transmitting photographs, video clips, sound files, and short text messages over wireless networks.

 **NOTE:** Sending MMSs might incur extra costs which may vary depending on your service provider.

When the phone radio is turned on for the first time, the **HP iPAQ DataConnect** application detects the mobile phone service provider and automatically populates the MMS settings on the HP iPAQ.

Alternately, you can access some MMS settings by pressing the left softkey > **Menu > Options > Accounts > MMS > Preferences**. It is not recommended to change the MMS settings provided by your mobile phone service provider unless they request the change.

MMS composer

With MMS composer you can create and share your own MMS messages. You can also add pictures, videos, text, and audio to your MMS messages.

To access MMS application, press the left softkey > **MMS**

MMS account has its own set of folders with five default Messaging folders:

- Deleted Items
- Drafts
- Inbox
- Outbox
- Sent Items

To create an MMS message:



1. Press the left softkey > **MMS**.
2. From any MMS folder, tap **Menu > New**
3. To add picture or video to the message, tap the **Insert picture/video** field, and then tap the required picture or video to be added.



NOTE: To view the video clip before adding, navigate to the required file and tap the  (Play) button.

4. To insert text in the message, tap the **Insert text here** field and type the required text.



NOTE: You can also insert a smiley by tapping the  (Smiley) icon, favorite Web link by tapping the  (Favorites) icon, and templates stored in **My Text** by tapping the  (Text) icon.

5. To add an audio clip to message, tap **Insert audio** and tap the required audio to be added.



NOTE: To listen to the audio clip before adding, navigate to the required file and tap  (Play) button.

6. To preview the MMS message, tap the  (Play) icon at the left bottom of the screen.



NOTE: To use a pre-made message template, tap **Menu > Template > New from template > OK**. Select the **Always choose custom** check box to view a blank message automatically.

NOTE: You can also add pictures, videos, and text by navigating to the required file and tapping **Select**.

Receive attachments

An attachment sent with an e-mail message or downloaded from the server is displayed below the subject of the message. Tapping the attachment opens the attachment if it has been fully downloaded or marks it for download the next time you send and receive e-mail. You can also download attachments automatically with your messages if you have an Outlook e-mail or IMAP4 e-mail account.

If you have an Outlook e-mail account, do the following:

1. Tap **Start > Programs > ActiveSync**.
2. Tap **Menu > Options...**
3. Tap **E-mail > Settings**, and then select **Include file attachments**.

If you have an IMAP4 e-mail account with an ISP or an account that you access using a VPN server connection (typically a work account), do the following:

1. Press the left softkey to open the messaging application.
2. Tap **Menu > Options**
3. Tap the name of the IMAP4 account.
4. Tap **Next** until you reach **Server information**, and tap **Options...**
5. Tap **Next** twice, and select **Get full copy of messages** and **When getting full copy, get attachments**.

 **TIP:** Embedded pictures and objects cannot be received as attachments.

An embedded message can be viewed as an attachment when using IMAP4 to receive e-mail. However, this feature does not work if Transport Neutral Encapsulation Format (TNEF) is enabled so that you can receive meeting requests.

To store attachments on a storage card rather than on the device, press the left softkey > **Menu > Options > Storage**, and select the **When available, use this storage card to store attachment** check box.

Receive meeting requests

If you receive your e-mail messages through ActiveSync, you can receive meeting requests. When connecting directly to an e-mail server, the server must be running Microsoft Exchange Server version 5.5 or later for you to receive meeting requests.

If the server is running Microsoft Exchange Server 2000 or later, your meeting requests are automatically received in your Inbox. However, to receive meeting requests on Microsoft Exchange Server 5.5, do the following:

- Ask your system administrator to activate Rich Text Format (RTF) and TNEF support for your account.

With TNEF enabled, your messages that are included in other messages as attachments are not received, and you cannot know if a message has an attachment until you get the full copy. In addition, download time might be longer.

- Change e-mail download options if your account is not set up to receive attachments.

After you are set up to receive meeting requests, do the following:

1. Open the meeting request.
2. Tap **Accept**, or **Menu > Tentative**, or **Menu > Decline**. If you want, you can also include a message with the response. The response will be sent the next time that you synchronize or connect to your e-mail server, and your device calendar will be updated.

Create or change a signature

To create or change a signature:

1. Press the left softkey to open the messaging application.
2. Tap **Menu > Options... > Signatures...**
3. Select the account for which you want to create or change a signature.
4. Select the **Use signature with this account** check box if it is not already selected.

5. Select the **Use when replying and forwarding** check box if required.
6. Enter a signature in the box.

To stop using a signature, clear the **Use signature with this account** check box.

 **TIP:** You can use a different signature with each messaging account.

Use messaging

Compose and send messages

To compose and send messages:

1. Press the left softkey to open the messaging application.
2. Tap the account to want to compose a message in, and then tap **Menu > New**.
3. Enter the e-mail address or text message address of one or more recipients, separating them with a semicolon. To access addresses and phone numbers from **Contacts**, tap **To** or tap **Menu > Add Recipient**.
4. Enter your message. To quickly add common messages, tap **Menu > My Text** and tap the required message.
5. To check the spelling, tap **Menu > Spell Check**.
6. Tap **Send**.

 **TIP:** To set the priority, tap **Menu > Message Options...**

Reply or forward a message

To reply or forward a message:

1. Tap on the message to open it, and then tap **Menu > Reply**, **Reply All**, or **Menu > Forward**.
2. Enter your response. To quickly add common messages, tap **Menu > My Text** and tap the required message.
3. To check the spelling, tap **Menu > Spell Check**.
4. Tap **Send**.

 **NOTE:** If you want to keep the original text with the outgoing message, tap **Menu > Options** then tap **Message**. You must check the **When replying to e-mail, include body** option.

Add an attachment to a message

To add an attachment to a message:

1. In an open message, tap **Menu > Insert** and tap the item you want to attach: **Picture**, **Voice Note**, or **File**.
2. Select the file you want to attach or record a voice note.

 **NOTE:** Embedded objects cannot be attached to messages.

Download messages

The manner in which you download messages depends on the type of account you have:

- To send and receive e-mail for an Outlook e-mail account, begin synchronization through ActiveSync.
- Text messages are automatically received when your HP iPAQ phone mode is switched on. When your HP iPAQ is switched off (in flight mode), messages are held by your service provider until the next time your HP iPAQ is turned on.

 **TIP:** By default, messages you send are not saved on your device to help conserve memory. If you want to keep copies of sent messages in the messaging list, tap **Menu > Options > Message**, and select the **Keep copies of sent items in Sent folder** check box. If your account is an Outlook e-mail or IMAP4 account, you must also select the Sent Items folder for synchronization. To do this, press the left softkey > **Outlook E-mail**, and then tap **Menu > Tools > Manage Folders...** and select the check box next to the **Sent Items** folder.

Download messages from a server

To download messages from a server:

1. From any account, tap **Menu > Go To** and tap the account you want to use.
2. Tap **Menu > Send/Receive**.

The messages on your device and e-mail server are synchronized. New messages are downloaded to the device **Inbox** folder, messages in the device **Outbox** folder are sent, and messages that have been deleted from the server are removed from the device **Inbox** folder.

 **TIP:** To read the entire message, tap **Menu > Download Message** while in the message window. If you are in the message list, tap and hold the message, and then tap **Menu > Download Message**. The message will download the next time you send and receive e-mail. This will also download message attachments if you have selected those options while setting up your e-mail account.

The size column in the message list displays the local size and server size of a message. These numbers might differ because the size of a message can vary between the server and the device.

Install an online address book

Many e-mail servers, including servers running Exchange Server, can verify names with an online address book called a directory service, using a protocol known as Lightweight Directory Access Protocol (LDAP). When you create an e-mail account, the directory service of your e-mail server is added to the **Address**, and you are given the option to enable it. After it is enabled, Messaging checks your contact list and then the directory service to verify names that you enter in the **To**, **Cc**, and **Bcc** fields. To enable a directory service or if you want to use additional services, follow these steps:

1. If you are adding a new account, ask your network administrator for the name of the directory service and the server.
2. In the message list, tap **Menu > Tools > Options > Address**.
3. In the **In Contacts, get e-mail addresses from** list, select which e-mail address book to check in contacts. Contacts will be checked first unless you select **None**.
4. If your e-mail server is already listed, select the server's directory service check box to enable it and tap **ok**.
5. If your e-mail service is not listed, tap **Add...**

6. In the **Directory name** and **Server** boxes, enter the LDAP directory and server names.
7. Ask your network administrator if authentication is necessary for your server. If so, select the **Authentication is necessary on this server** check box, and enter your user name and password.
8. To have messaging check this service, select the **Check name against this server** check box.

 **TIP:** To delete a service, tap and hold the service, and then tap **Delete**.

While synchronizing your Outlook e-mail account, disable any directory services you have installed by clearing the **Check name against this server** check box. This helps avoid getting error messages when **Messaging** tries to verify names against the service that you are not connected to.

13 Calendar

Access calendar

Use Calendar to schedule appointments, including meetings and other events. You can display appointments for the day on the **Today** screen.

- To access Calendar, on the Today screen tap .

Change the display of the work week

You can customize your calendar for a work week to start on Sunday or Monday. You can schedule your calendar for a five to seven-day week.

To change the display of the work week:

1. On the Today screen, tap .
2. Tap **Menu > Tools > Options...** and do one or both of the following:
 - To specify the first day of the week, tap **Sunday** or **Monday** in the **1st day of week** box.
3. To specify the number of days to appear in a work week, tap **5-day week**, **6-day week**, or **7-day week** in the **Week view** box.
4. Tap **ok**.

Set a default reminder for all new appointments

To automatically turn on a reminder for all new appointments:

1. On the Today screen, tap .
2. Tap **Menu > Tools > Options... > Appointments**.
3. Select the **Set reminders for new items** check box.
4. Set the time for the reminder to alert you.
5. Tap **ok**.

Update an appointment

To update an appointment on your calendar:

1. On the Today screen, tap .
2. Tap to open the appointment, and then tap **Menu > Edit** to make your changes.
3. Tap **All**, **One**, or **Cancel**.
4. Make the required changes, and then tap **ok**.

Cancel an appointment

When you delete an appointment in calendar on your HP iPAQ, it is also deleted on your computer the next time you synchronize. If the appointment has not been synchronized with a computer, it will be deleted only from your HP iPAQ.

To cancel an appointment:

1. On the Today screen, tap .
2. In **Agenda** view, select the appointment to delete.

 **NOTE:** Move your fingers from north to south direction on the **Smart-Touch Navigation** wheel to scroll through appointments.

3. Tap **Menu > Delete Appointment**.
4. Tap **Yes** to delete the appointment, or tap **No** to keep it.

 **NOTE:** In views other than the **Agenda** view, use the **Smart-Touch Navigation** wheel or the **3-Way Thumb-Wheel** to scroll and select an appointment, and then tap **Menu > Delete Appointment**.

14 Contacts

Create a contact

To create a contact:

1. Tap **Start > Contacts**.
2. Tap **New** and enter the contact information in **Outlook Contact** or **SIM Contact**.
3. When finished, tap **ok**.

 **NOTE:** If your contact list has been filtered by a category when you create a contact, that category is automatically assigned to the new contact.

If most of the contacts you create have phone numbers that begin with the same area code, in the **Contacts**, tap **Menu > Options...** and enter that area code in the **Area code** box and tap **ok**.

If you receive a call from a number that is not listed in your contacts, you can create a contact from the call history.

 **NOTE:** For more information, from the same screen tap **Start > Help**.

Delete a contact

To delete a contact:

1. Tap **Start > Contacts**.
2. Tap and hold the contact to delete.
3. Tap **Delete Contact**.
4. Tap **ok**.

Change contact information

To change contact information:

1. Tap **Start > Contacts**.
2. Tap the contact.
3. Tap **Menu > Edit** and enter the changes.
4. When finished, tap **ok**.

Copy a contact

To copy a contact:

1. Tap **Start > Contacts**.
2. Tap and hold the contact you want to copy.

3. Tap **Copy Contact**.
4. Tap the copy of the contact.
5. Tap **Menu > Edit**.
6. Change the contact information as needed and tap **ok**.

 **NOTE:** The displayed category is automatically assigned to the new contact.

Find a contact

To find a contact:

1. Tap **Start > Contacts**.
2. If you are not in **Name** view, tap **Menu > View By > Name**.
3. Do one of the following:
 - Begin entering a name or phone number in the provided text box until the contact you want is displayed. To show all contacts again, tap the text box and clear the text, or press the back space/clear key.
 - Use the alphabetical index displayed at the top of the contact list.
 - Filter the list by categories. In the contact list, tap **Menu > Filter**. Then tap a category you have assigned to a contact. To show all contacts again, select **All Contacts**.

 **NOTE:** To search for a contact by entering a name or number, or by using the alphabetical index, you need to be in **Name** view.

Send an E-mail message to a contact

To send an e-mail message to a contact:

1. Tap **Start > Contacts**.
2. Tap the contact you want to send a message to.
3. Tap the address you want to send a message to.
4. Tap the account you want to send the message from.

 **NOTE:** To quickly add a contact's address to a new message, tap **To**, **Cc**, or **Bcc** line, and then tap **Menu > Add Recipient**. Tap the contact you want to send the message to and choose the address, if necessary.

Send a text message to a contact

To send a text message to a contact:

1. In the message list, tap **Menu > Go To** and select the account.
2. Tap **Menu > New**.
3. Enter the text message address of one or more recipients, separating them with a semicolon. To access addresses and phone numbers from **Contacts**, tap **To**.
4. Enter your message. To quickly add common messages, tap **Menu > My Text** and tap the required message.

 **NOTE:** To enter symbols, tap **Shift** using the on-screen keypad.

5. To check the spelling, tap **Menu > Spell Check**.

 **NOTE:** To set the priority, tap **Menu > Message Options...**

6. Tap **Send**.

If you are sending a text message and want to know if it was received, before sending the message, tap **Menu > Tools > Options...** Tap **Accounts > Text Messages** and select **Request delivery notifications** check box.

Add and remove a picture

To add a picture to the contact information:

1. Tap **Start > Contacts**.
2. Tap the contact.
3. Tap **Menu > Edit**.
4. Tap **Picture**.
5. Do one of the following:
 - Tap the picture you want to add.
 - Tap **Camera** and take a picture.

To remove a picture from the contact information:

1. Tap **Start > Contacts**.
2. Tap the contact.
3. Tap **Menu > Edit**.
4. Tap **Menu > Remove Picture**.

Use the contact list

There are several ways to use and customize the contact list. You can also make a call or send a message from an open contact.

To customize the contact list:

1. Tap **Start > Contacts**.
2. In the contact list, do any of the following:
 - To search for a contact by entering a name or by using the alphabetical index, enter the name into the **Enter a name...** box.
 - To see a list of contacts employed by a specific name or company, tap **Menu > View By > Name or Company**.
 - To see a summary of information about a contact, tap the contact. From there, you can also make a call or send a message.
 - To see a list of available actions for a contact, tap and hold the contact.

 **NOTE:** To display a greater number of contacts on the screen, tap **Menu > Options...**, select the **Show contact names only** check box, and clear the **Show alphabetical index** check box.

15 Connections

You can use your HP iPAQ to connect and exchange information with other handheld devices, computer, and other networks. You can connect using:

- Wi-Fi
- Bluetooth
- GPRS/EDGE/HSDPA/WCDMA

You can connect by tapping **Start > Settings > Connections**.

Use Wireless Manager

Using Wireless Manager, you can easily turn on/off the functions of a Wi-Fi connection, a Bluetooth connection, and Phone features.

 **NOTE:** When the Phone feature is turned off, you cannot receive or make a call, including emergency calls. To receive and make a call, turn on the Phone feature and re-engage your phone's RF capability.

To use wireless manager, press **Start > Settings > Connections > Wireless Manager**.

Option	Description
All	Tap All to turn on/off the functions of Wi-Fi , Bluetooth , and Phone features.
Wi-Fi	Tap Wi-Fi to turn on/off the functions of Wi-Fi connection.
Bluetooth	Tap Bluetooth button to turn on/ off the functions of Bluetooth connection.
Phone	Tap Phone button to turn on/off the functions of Phone features.

Flight mode is a condition when all wireless connections on your HP iPAQ are turned off.

To turn on/off all wireless connections at the same time:

1. To use Wireless Manager, tap **Start > Settings > Connections > Wireless Manager**.
2. Tap **All** to turn on/off all wireless connections.

Wi-Fi

With wireless access, you do not need to use cables to connect your HP iPAQ to the Internet. Instead, access points transmit data to and from your wireless device. Your HP iPAQ can connect to an 802.11b/g Wi-Fi or connect directly to other Wi-Fi-enabled devices.

With Wi-Fi, you can:

- Access the Internet.
- Send and receive e-mail.
- Access corporate network information.

- Use VPNs for secure remote access.
- Use hotspots for wireless connectivity.

Tap **Start > Settings > Connections > Wi-Fi**

 **NOTE:** Using dial-up or wireless networks to access a corporate network, e-mail, or other wireless communications, such as Bluetooth devices might require separate hardware along with a Wi-Fi infrastructure and a service contract.

Check with your service provider for availability of network coverage in your area. Not all Web content might be available. Some Web content might require installation of additional software.

Wi-Fi Terms

It is recommended that you become familiar with the following terms as you use Wi-Fi.

Term	Definition
802.11 standard	An approved standard specification of radio technology from the Institute of Electrical and Electronics Engineers (IEEE) used for wireless local area networks (Wi-Fi).
Device-to-computer or ad-hoc	A mode that does not use access points. It provides independent peer-to-peer connectivity in a wireless LAN.
Domain Name System (DNS)	The way that Internet domain names are located and translated into IP addresses. It is an easy name to remember for an Internet address. Every Web site has its own specific IP address on the Internet.
Encryption	An alphanumeric (letters and/or numbers) conversion process of data primarily used for protection against any unauthorized people.
Hotspots	Public or private areas where you can access Wi-Fi service. These wireless connections can be located, for example, at a library, cyber cafe, hotel, airport lounge, or convention center. This service can be free or sometimes requires a fee.
Infrastructure	This connection mode uses wireless access points to connect to networks.

Open Wi-Fi settings

To open Wi-Fi settings:

1. Tap **Start > Settings > Connections > Wireless Manager**.
2. Tap **Menu > Wi-Fi Settings**.

Automatically connect to a Wi-Fi network

When you try to connect to a Wi-Fi network, the HP iPAQ automatically detects Wi-Fi networks that are broadcasting their signal. If your Wi-Fi network is not set to broadcast, then you have to connect to it manually. While trying to connect to a Wi-Fi network if authentication is required, contact your network administrator for the details and enter the authentication information appropriately.

To automatically connect to a Wi-Fi network:

1. Tap **Start > Settings > Connections > Wireless Manager > Wi-Fi**.
2. Once your HP iPAQ detects a Wi-Fi network, you are asked to choose if you want to connect. Select the network you want to get connected to and tap **Connect**.

Manually connect to a Wi-Fi network

You can manually configure a wireless network by entering the required settings information.

To manually connect to a Wi-Fi network:

1. Tap **Start > Settings > Connections > Wi-Fi**.
2. Tap **Wireless>Add New....**
3. Enter the network name.
4. Select **The Internet** to connect to the Internet through an ISP or select **Work** to connect to a company network in the **Connects to** list.

 **NOTE:** You should select **Work** if the network requires a proxy server.

5. Tap **Next**.
 - To use authentication, select an authentication method from the **Authentication** list.
 - To use data encryption, select an encryption method from the **Data Encryption** list.
 - To automatically use a network key, tap **The key is automatically provided** check box, else enter the **Network key** and **Key index**.

Find an IP address

You need to determine your IP address to make sure that an address is assigned to the network and your HP iPAQ is able to access the network.

To find an IP address:

1. Connect to a network automatically or manually by tapping **Start > Settings > Connections > Wi-Fi > Network Adapters**.
2. Select an adapter in the **Tap an adapter to modify settings** list. The Wi-Fi IP address is displayed in the **IP address** box.

Delete a Wi-Fi network

You can delete networks you manually entered. However, you cannot delete automatically detected networks.

To delete an existing or available wireless network:

1. Tap **Start > Settings > Connections > Wi-Fi**.
2. Tap **Wireless**.
3. In the **Configure Wireless Networks** box, select the Wi-Fi network you want to delete.
4. Tap **Menu> Remove Settings**.

Bluetooth

Bluetooth terms

It is recommended that you become familiar with the following terms as you begin to use Bluetooth technology.

Term	Definition
Authentication	Verification of a numeric passkey before a connection or activity can be completed.
Authorization	Approval of a connection, access, or activity before it can be completed.
Bonding (Paired devices)	Creating a trusted connection between your device and another. After a bond is created, the two devices become paired. A paired device does not require authentication or authorization.
Device address	Unique electronic address of a Bluetooth device.
Device discovery	Location and recognition of another Bluetooth device.
Device ID	Name that a Bluetooth device provides when discovered by another device.
Encryption	Method of protecting data.
Passkey	Code you enter to authenticate connections or activities requested by other devices.
Personal Information Manager (PIM)	Collection of programs used to manage daily business tasks (for example: Contacts, Calendar, and Tasks).
Profiles	Collection of Bluetooth settings.
Service discovery	Determination of which programs you have in common with other devices.

Open Bluetooth settings

To open Bluetooth settings:

1. Tap **Start > Settings > Connections > Wireless Manager**.
2. Tap **Menu > Bluetooth Settings**.

Connect to a computer using Bluetooth

For best results, connect your HP iPAQ to the computer using USB to establish a synchronization before connecting via Bluetooth.

To connect to a computer via Bluetooth using ActiveSync:

1. Follow the instructions in synchronization software help on the computer for configuring Bluetooth on your computer to support ActiveSync.
2. On your HP iPAQ, tap **Start > Programs > ActiveSync**.
3. Tap **Menu > Connect via Bluetooth**. Make sure the device and computer are within close range.
4. If this is the first time you have connected to this computer via Bluetooth, complete the Bluetooth wizard on your HP iPAQ and set up a Bluetooth partnership with the computer.
5. Tap **Sync**.
6. When finished, tap **Menu > Disconnect Bluetooth**.

 **TIP:** To preserve battery power, turn off Bluetooth.

To connect to a computer via Bluetooth using WMDC:

1. Follow the instructions in synchronization software help on the computer for configuring Bluetooth.
2. On your HP iPAQ, tap **Start > Programs > ActiveSync**.
3. Tap **Menu > Connect via Bluetooth**. Make sure the device and computer are within close range.
4. When prompted, if you would like to set up a partnership, tap **Yes**.
5. On the computer, when prompted that a Bluetooth device is attempting to connect with the computer, click **To allow this connection**.
6. To disconnect, tap **Menu > Disconnect**.

Create, end, and accept a Bluetooth partnership

You can exchange information between your HP iPAQ and another device that has Bluetooth capabilities. For this, you will have to first create a Bluetooth partnership between the two devices.

 **NOTE:** To exchange information between two Bluetooth-enabled devices, make sure Bluetooth is turned on both devices. The devices need to be in the discoverable mode.

To create a Bluetooth partnership:

1. Tap **Start > Settings > Connections > Bluetooth**.
2. Tap **Add new device....** Your HP iPAQ searches for other devices with Bluetooth capabilities and displays them in the list.
3. Tap the name of the other device, and tap **Next**.
4. If you want to set a passcode, which is recommended for enhanced security, enter an alphanumeric passcode between 1 and 16 characters in the **Passcode** box, and tap **Next**. Else, leave the passcode blank, and tap **Next**.

 **NOTE:** For creating partnerships with cellular phones, it is mandatory that you provide a numeric passcode.

5. Enter the same passcode on the other device.
6. Tap **Finish**.
7. To give the partnership a more meaningful name, tap and hold the device name under **My Shortcuts**, then tap **Rename**.

To end a Bluetooth partnership:

1. Tap **Start > Settings > Connections > Bluetooth**.
2. Tap and hold the partnership you want to end.
3. Tap **Delete**.

To accept a Bluetooth partnership:

1. Make sure that your HP iPAQ is discoverable and placed within close range with the pairing device.
 - Tap **Start > Settings > Connections > Bluetooth > Mode**.
 - Select the **Make this device visible to other devices** check box.
2. When prompted to accept a partnership with the device that is requesting the relationship, tap **Yes**.

3. If a passkey is requested, enter an alphanumeric passkey between 1 and 16 characters in **Passkey** box and tap **Next**. Enter the same passkey in the device requesting the partnership. Using a passkey provides greater security.
4. Tap **Finish**.

If you cannot discover another device, try the following:

- Make sure Bluetooth is turned on.
- Move closer to the device.
- Make sure the device you are attempting to connect is on and is visible to other devices.

Edit a Bluetooth partnership

To rename a Bluetooth partnership:

1. Tap **Start > Settings > Connections > Bluetooth**.
2. Tap and hold the partnership you want to edit.
3. Tap **Edit**.
4. In the **Display Name** box, enter a new name for the partnership.
5. Tap **Save**.

Use your HP iPAQ as a wireless modem with Bluetooth

You can use your HP iPAQ as a wireless modem to connect your Bluetooth-enabled computer to the Internet.

To use HP iPAQ as a wireless modem with Bluetooth:

1. Turn on Bluetooth on both, your HP iPAQ and your computer.
2. Make sure that your HP iPAQ is discoverable.
 - Tap **Start > Settings > Connections > Bluetooth > Mode**.
 - Select the **Make this device visible to other devices** check box.
3. Select your HP iPAQ from the list and perform the necessary procedure to pair the devices via Bluetooth.
4. Once the devices are paired, discover the available Bluetooth services offered by the HP iPAQ and select **dial-up networking**.
5. On your HP iPAQ, tap **Accept** to complete the connection, if you are asked to do so.
6. On your computer, a user name and password screen is displayed. Contact your mobile phone service provider to obtain the appropriate username and password.
7. Enter ***99** in the dial field and tap **Talk**.

 **NOTE:** The computer initially indicates that your HP iPAQ is dialing. After a short period of time, it displays the network is verifying the username and password. Next, the computer registers on the network and connects.

Your HP iPAQ displays a notification indicating an active connection.

 **NOTE:** If you tap on the icon, the notification displays again, and it allows you to disconnect or re-hide the notification. The GPRS icon does not change to show when you are connected.

Bluetooth device profiles

The functions that Bluetooth supports are called services or profiles. You can communicate only with Bluetooth devices that support at least one of the following profiles:

- ActiveSync over Bluetooth (ActiveSync)
- Advanced Audio Distribution Profile (A2DP)
- Audio Video Remote Control Profile (AVRCP)
- Generic Access Profile (GAP)
- Hands Free Profile (HFP)
- Headset Support Profile (HSP)
- Human Interface Device Profile (HID)
- Generic Object Exchange Profile (GOEP)
- Object Push Protocol (OPP)
- Personal Area Networking Profile (PAN)
- Serial Port Profile (SPP)
- Dial-up Networking Profile (DUN)

Access services

If you choose to require authorization to access services, you have to authorize each connection. Your HP iPAQ always asks you if the connection should be permitted.

To set authorization to access services:

1. Tap **Start > Settings > Connections > Wireless Manager**.
2. Tap **Menu > Bluetooth Settings**.
3. Tap the service you want to enable: **Devices, Mode, COM Ports**.

Set a Bluetooth shared folder

You can determine the folder that other devices access when they connect to your HP iPAQ.

1. Tap **Start > Settings > Connections > Wireless Manager**.
2. Tap **Menu > Bluetooth Settings**.
3. Tap **File Transfer**.
4. Enter the folder name where you would like to save the transferred files in the **Root directory** box.
5. Tap **ok**.

Set up an incoming or outgoing Bluetooth COM port

To set up incoming or outgoing Bluetooth COM port:

1. Make sure your HP iPAQ is connected to the other device via Bluetooth.
2. Tap **Start > Settings > Connections > Wireless Manager**.
3. Tap **Menu > Bluetooth Settings**.

4. Tap **COM Ports**.
5. Tap **New Incoming Port** or **New Outgoing Port**.

 **NOTE:** **New Outgoing Port** is only available if at least one Bluetooth device supports serial (COM) connection.

6. Select a numbered COM port from the list.

 **NOTE:** If the port cannot be created, it is in use. Select a different numbered port.

7. To limit communication on this COM port to only devices with which the HP iPAQ has a Bluetooth partnership, select the **Secure Connection** check box.

8. Tap **Finish**.

GPRS/EDGE/HSDPA

GPRS/EDGE

GPRS/EDGE technology provides a connection to the Mobile Phone Network that can be used for Web browsing, MMS messaging, or accessing your corporate network.

 **NOTE:** EDGE is an enhancement to GPRS technology and enables higher speed data connections than GPRS. This means faster phone multimedia capabilities such as sending and receiving SMS/MMS messages, and sharing video clips. Check with your service provider to see if they support EDGE technology. If your service provider does not support the EDGE network, the HP iPAQ defaults to GPRS.

HSDPA

High Speed Download Packet Access (HSDPA) is an enhancement of Wideband Code Division Multiple Access (WCDMA) which is based on 3G technology, and offers better data compression. Your HP iPAQ supports HSDPA 3.6 to 7.2 mbps that uses WCDMA for high speed downloads. HP iPAQ also supports WCDMA over three different frequency bands (850/1900/2100). When WCDMA or HSDPA is available, the device uses the technology and reverts back to GSM/GPRS/EDGE if WCDMA or HSDPA is unavailable. Your HP iPAQ also supports WCDMA/HSDPA in three different frequency bands (850/1900/2100).

Differences between GSM and GPRS/EDGE/WCDMA/3G technology

GSM technology is typically used for voice calls and text messaging, whereas GPRS/EDGE/WCDMA/3G technology provides a connection to the Mobile Phone Network that can be used for Web browsing, Multimedia Messaging Service (MMS), or accessing your corporate network.

 **NOTE:** Using GPRS/EDGE/WCDMA/3G data services are typically an additional charge to your standard mobile phone service. Check with your mobile phone service provider for data services and cost.

Configure GPRS network settings

The first time you use your SIM card, **HP iPAQ DataConnect** automatically detects the phone network and operator and sets up the GPRS connection information for you. You can change these settings to suit your preference or create your own network settings.

To configure GPRS network settings:

1. Tap **Start > Settings > Connections > HP iPAQ DataConnect**.
2. If your operator name displays in the **Operator** drop-down list, it is recommended that you use that connection and, if needed, edit the default settings.

Edit an Internet connection

To edit an Internet connection:

1. Tap **Start > Settings > Connections > Connections > Advanced > Select Networks**.
2. Select the **iPAQ GPRS** option from the **Programs that automatically connect to the Internet should connect using** list.
3. Tap **Edit... > Modem**.
4. Select the required ISP from the displayed list and tap **Edit...**
5. Enter a service provider name in the **Enter a name for the connection** box and tap **Next**.
6. Enter an access point name of the server to which you are attempting to connect in the **Access point name** box and tap **Next**.
7. Enter the user name and password.
8. Enter a domain name if provided by your ISP.
9. Tap **Finish**.

Alternatively, you can also follow the steps given below to edit an Internet connection:

1. Tap **Start > Settings > Connections > Connections > Advanced > Select Networks**.
2. Select the **iPAQ GPRS** option from the **Programs that automatically connect to the Internet should connect using** list.
3. Tap **New... > Modem**.
4. Enter a name for the settings. This name is for your reference.
5. Tap **Modem > New...**
6. Enter a service provider name in the **Enter a name for the connection** box.
7. Select the appropriate modem from the **Select a modem** list.

To configure settings using a telephone number:

- a. Select the **Cellular Line** option from the **Select a modem** list.
- b. Tap **Next**.
- c. Enter the appropriate country/region and area codes.
- d. Enter a telephone number in the **Phone number** box and tap **Next**.

To configure settings using access points:

- a. Select the **Cellular Line (GPRS, 3G)** option from the **Select a modem** list.
- b. Tap **Next**.
- c. Enter an access point name of the server to which you are attempting to connect in the **Access point name** box and tap **Next**.

8. Enter the user name and password.
9. Enter a domain name if provided by your ISP.

Edit MMS settings

To edit an Internet connection:

1. Tap **Start > Settings > Connections > Connections > Advanced > Select Networks**.
2. Select the **iPAQ MMS** option from the **Programs that automatically connect to the Internet should connect using** list.
3. Tap **Edit... > Modem**.
4. Select the required ISP from the displayed list and tap **Edit...**
5. Enter a service provider name in the **Enter a name for the connection** box and tap **Next**.
6. Enter an access point name of the server to which you are attempting to connect in the **Access point name** box and tap **Next**.
7. Enter the user name and password.
8. Enter a domain name if provided by your ISP.
9. Tap **Finish**.

Alternatively, you can also follow the steps given below to edit an Internet connection:

1. Tap **Start > Settings > Connections > Connections > Advanced > Select Networks**.
2. Select the **iPAQ MMS** option from the **Programs that automatically connect to the Internet should connect using** list.
3. Tap **New... > Modem**.
4. Enter a name for the settings. This name is for your reference.
5. Tap **Modem > New...**
6. Enter a service provider name in the **Enter a name for the connection** box.
7. Select the appropriate modem from the **Select a modem** list.

To configure settings using a telephone number:

- a. Select the **Cellular Line** option from the **Select a modem** list.
- b. Tap **Next**.
- c. Enter the appropriate country/region and area codes.
- d. Enter a telephone number in the **Phone number** box and tap **Next**.

To configure settings using access points:

- a. Select the **Cellular Line (GPRS, 3G)** option from the **Select a modem** list.
 - b. Tap **Next**.
 - c. Enter an access point name of the server to which you are attempting to connect in the **Access point name** box and tap **Next**.
8. Enter the user name and password.
 9. Enter a domain name if provided by your ISP.

Edit WAP information settings

To edit an Internet connection:

1. Tap **Start > Settings > Connections > Connections > Advanced > Select Networks**.
2. Select the **iPAQ WAP** option from the **Programs that automatically connect to the Internet should connect using** list.
3. Tap **Edit... > Modem**.
4. Select the required ISP from the displayed list and tap **Edit...**
5. Enter a service provider name in the **Enter a name for the connection** box and tap **Next**.
6. Enter an access point name of the server to which you are attempting to connect in the **Access point name** box and tap **Next**.
7. Enter the user name and password.
8. Enter a domain name if provided by your ISP.
9. Tap **Finish**.

Alternatively, you can also follow the steps given below to edit an Internet connection:

1. Tap **Start > Settings > Connections > Connections > Advanced > Select Networks**.
2. Select the **iPAQ WAP** option from the **Programs that automatically connect to the Internet should connect using** list.
3. Tap **New... > Modem**.
4. Enter a name for the settings. This name is for your reference.
5. Tap **Modem > New...**
6. Enter a service provider name in the **Enter a name for the connection** box.
7. Select the appropriate modem from the **Select a modem** list.

To configure settings using a telephone number:

- a. Select the **Cellular Line** option from the **Select a modem** list.
- b. Tap **Next**.
- c. Enter the appropriate country/region and area codes.
- d. Enter a telephone number in the **Phone number** box and tap **Next**.

To configure settings using access points:

- a. Select the **Cellular Line (GPRS, 3G)** option from the **Select a modem** list.
 - b. Tap **Next**.
 - c. Enter an access point name of the server to which you are attempting to connect in the **Access point name** box and tap **Next**.
8. Enter the user name and password.
 9. Enter a domain name if provided by your ISP.

Troubleshoot automatic detection

If the automatic detection setting fails, complete one or more of the following items:

- Check to see if the SIM card is present in the HP iPAQ. If it is not present, insert the SIM card and relaunch the application.
- Ensure that the metal contacts on your SIM card and your SIM slot are not covered with a residue or dust that would inhibit a connection.
- In the **HP iPAQ DataConnect** application, select the appropriate country and operator name, and then tap **ok**. The settings automatically update.
- In the **HP iPAQ DataConnect** application, if your operator name does not appear in the drop-down list, you must manually add it to the list by tapping the down arrow in the **Operator** box and tapping **Create New**.

Advanced settings

Connect to intranet URLs

To connect to intranet sites that have periods in their URLs (for example, intranet.companyname.com), add them to the **Work URL Exceptions** list.

To connect to intranet URLs:

1. Tap **Start > Settings > Connections > Connections > Advanced > Exceptions...**
2. Tap **Add new URL...**
3. In **Work URL**, enter the intranet URL.

 **NOTE:** If you use many URLs that share the same root company name, you can avoid entering them individually by entering ***.companyname.com**.

Change an intranet URL

To change an intranet URL:

1. Tap **Start > Settings > Connections > Connections > Advanced > Exceptions**.
2. Tap the intranet URL exception you want to change, then make the required changes.

 **NOTE:** To delete a work URL exception, tap and hold it in the list, then tap **Delete**.

Set up an automatic choice for connections

If you have already created more than one connection, you can set up your HP iPAQ to connect to the best available connection automatically.

To set up an automatic choice for connections:

1. Tap **Start > Settings > Connections > Connections > Tasks**.
2. Under **My ISP** or **My Work Network**, tap **Add a new modem connection** to create a new connection.
3. After you create a new connection, under **My ISP** or **My Work Network**, tap **Manage existing connections**.
4. Tap **Auto pick**.

 **NOTE:** For **Auto pick** option to be available, you need more than one connection.

Set up a WAP gateway

To access Wireless Access Point (WAP) sites through Internet Explorer, configure your device to use a WAP gateway.

Before you begin, obtain the following information from your ISP or network administrator:

- User name
- Password
- ISP server phone number
- WAP gateway server IP
- Port number

To set up a WAP gateway:

1. Tap **Start > Settings > Connections > Connections > Advanced > Select Networks > Edit...** to edit **iPAQ WAP** from the **Programs that automatically connect to the Internet should connect using** list. If a proxy server has not been set up, tap **New...**
2. On the **Proxy Settings** tab, select the **This network connects to the Internet** and **This network uses a proxy server to connect to the Internet** check boxes.
3. If necessary, in the **Proxy server** box, enter the proxy server name.
4. Tap **Advanced > WAP**.
5. In the **Server** box, enter the WAP gateway server name. Under **Port**, enter the port number. The most common WAP port number is 9201.
6. Enter any logon credentials required by the WAP gateway server.

Configure advanced proxy settings

To configure advanced proxy settings:

1. Tap **Start > Settings > Connections > Connections > Advanced > Select Networks > Edit...** to edit **iPAQ WAP** from the **Programs that automatically connect to the Internet should connect using** list. If a proxy server has not been set up, tap **New...**
2. On the **Proxy Settings** tab, select the **This network connects to the Internet** and **This network uses a proxy server to connect to the Internet** check boxes.
3. If necessary, in the **Proxy server** box, enter the proxy server name.
4. For the appropriate server type, enter the proxy server name and port.
5. If necessary, enter the credentials for connecting with your proxy server.
6. Tap **Advanced > Socks**.
7. Select **Socks 4** or **Socks 5**. If using Socks 5, enter the credentials for connecting with your proxy server.

Advanced connection settings

To set up advanced connections:

1. To connect to a network, tap **Start > Settings > Connections > Connections > Advanced > Select Networks**.
 2. Select **My ISP** to connect to the Internet through an ISP or select **My Work Network** to connect to a company network. Select **My Work Network** if the network requires a proxy server. If you need to change or create a new network management name, tap **Edit...** or **New...**, and then tap **ok**.
 3. On the **Connections** screen, tap **Advanced > Dialing Rules**.
 4. To avoid creating a new connection for each location, select the **Use dialing rules** check box.
-
-  **NOTE:** You can edit a dialing rule by tapping **Edit** on the **Dialing Rules** screen. To do so, enter details such as **Name**, **Country code**, and **Area code**.
-
5. To create URL exceptions, tap **Exceptions > Add new URL** and tap **ok**.

Set up a VPN server connection

A VPN connection helps you to securely connect to servers, such as a corporate network, via the Internet.

Before you begin, obtain the following information from your network administrator:

- User name
- Password
- Domain name
- TCP/IP settings
- Host name or IP address of the VPN server

To set up a VPN server connection:

1. Tap **Start > Settings > Connections > Connections > Tasks**.
2. Under **My Work Network**, tap **Add a new VPN server connection** and follow the instructions in the New Connection wizard.
3. Under most circumstances, you should not change any advanced settings. However, you need to change advanced settings when:
 - The server to which you are connecting does not use dynamically-assigned addresses, and you need to enter your TCP/IP settings.
 - You need to change server DNS or WINS settings.If either of these circumstances applies, from the **My VPN** screen, tap **Advanced** and fill in the appropriate information. Tap **ok** to save the changes and return to the **My VPN** screen.
4. To view additional information for any screen in the wizard or while changing settings, tap **Help**.

Change a connection group name

Your device is already set up with two groups of connection settings: **My ISP** and **My Work Network**. You can also change the name of these groups. For example, if you put all of your corporate settings under **My Work Network Connections**, you can change the name to your company's name.

To change a connection group name:

1. Tap **Start > Settings > Connections > Connections**.
2. Under **My ISP** or **My Work Network**, tap **Add a new modem connection** to create a new connection.
3. After you create a new connection, under **My ISP** or **My Work Network**, tap **Manage existing connections**.
4. Tap **General**.
5. Enter a name for the settings group and tap **ok**.

End a connection

It is advised that you disconnect active connections on your HP iPAQ when not in use. This can save connection charges.

- When connected via cable, detach your HP iPAQ from the cable.
- When connected via Bluetooth, tap **Start > Settings > Connections > Wireless Manager**. Next, tap **Bluetooth** to turn Bluetooth off.

16 Google Maps™ for mobile

Google Maps is a free mapping application provided by Google that powers many map-based services. It offers street maps, a route planner, and an urban business locator for numerous countries around the world.

Google Maps includes the following features to help you enhance your travel experience:

- **Real-time traffic** – Identify the location where congestion exists and estimate delays in over 30 major US metropolitan areas.
- **Detailed directions** – Display maps with step-by-step directions whether you plan to walk or drive.
- **Integrated search results** – Display local business locations and contact information all in one place, integrated on your map.
- **Easily movable maps** – Enable you to zoom in or out maps, and move in all directions so you can orient yourself visually.
- **Satellite imagery** – Get a bird's eye view of your desired location.

 **NOTE:** Google offers maps for mobile for free, but mobile service providers may charge data-service rates for downloading and using the application with a limited data plan or no data plan. Contact your mobile service provider about an unlimited data plan, usually available for a flat monthly fee.

Launch and navigate Google Maps

To launch Google Maps:

1. Tap **Start > Google Maps**.
2. In the **Terms and Conditions** screen, tap **Accept**.
3. In the **About** screen, tap **ok**.

To navigate Google Maps:

1. Tap **Start > Google Maps**.
2. Tap **Menu > Directions...**
3. Enter your current location in the **From Location** box and destination in the **To Location** box.
4. Tap **ok** to start the search.

 **NOTE:** For more information on Google Maps, tap **Start > Google Maps > Menu > Help > Tips**.

Google Search

Google Mobile Web Search allows you to search for Web sites that are specifically designed for mobile phones and devices.

Launch Google Search

To launch Google Search:

1. Tap **Start** > **Google Search**.
2. Enter your Search criteria in the **Search** box.
3. Tap **Search** to start the search.

17 Using Global Positioning System (GPS) on your HP iPAQ

1. Set up the HP iPAQ.
2. Verify you have Internet access on your HP iPAQ by visiting a Web site such as <http://www.hp.com>.
3. Verify the correct date and time on your HP iPAQ.
4. Go to the location where the GPS Map is stored (ie On Device or Memory Card) and launch the navigation application.

 **NOTE:** Please refer to the detailed instructions from the navigation software vendor on how to use the application, as it varies from country/region.

 **WARNING!** When using hardware and software navigation aids, in a vehicle or elsewhere, it is your sole responsibility to place, secure, and use these aids in a manner that will not cause accidents, personal injury, property damage, or obstruct your view. You are solely responsible for observing safe driving practices. Do not operate this product while driving. Park the vehicle first. The HP iPAQ GPS navigation solution is intended for automotive use only.

If you are going to use GPS navigation in your vehicle for an extended period of time, charge your HP iPAQ using an Auto adapter.

 **NOTE:** It is recommended that you download all GPS maps to a memory card that is compatible with your specific HP iPAQ. This prevents you from losing your map data due to a possible power loss or a need to perform a clean reset on the HP iPAQ.

Common reasons for interference when using GPS software:

Interference Type	How to Avoid
Vehicles with thermal glass windows and windshields	Place the HP iPAQ where there is a clear view of the sky or on the dashboard of a vehicle that does not have thermal glass windows.
Cell Phones or other equipment radiating Radio Frequency (RF) energy or emitting strong electromagnetic radiation. For example, microwave ovens, high-power cordless phones, CB radios, Walkie-talkies, HAM equipment, or X-ray and MRI machines.	Move away from interference source or switch off the interference source.
Tall buildings, large trees, and very cloudy or overcast skies.	Move away from interference source so there is a clear view of the sky.

18 Applications

Enjoy with your HP iPAQ by listening to your favorite MP3 music using Windows Media Player. You can also record voice clips to be sent as an attachment to family and friends. Use Office Mobile applications to view presentations, spreadsheets, and documents.

HP applications

HP Help and Support

The **HP Help and Support** application increases visibility, accessibility, and usability of the HP iPAQ.

To access **HP Help and Support**:

1. Tap **Start > Programs > HP Help and Support**.
2. To view additional information, tap the appropriate HTML links.
 - **Serial and Model Numbers** – displays the product's serial number, model ID, product ID, and IMEI number.
 - **HP iPAQ Quick Tips** – launches the **HP iPAQ Tips** application, which will display tips to perform operations on your HP iPAQ in a quick and efficient way.
 - **Help Topics** – displays the **Help Topics** screen. Each of this help topic will provide information about features and steps to perform tasks.
 - **Customer Support** – launches the **Find More Information** table. This table displays help topic titles and the respective locations where you can find more information on the topics.
 - **System Details** – launches the **HP Asset Viewer** application, which displays information such as manufacturer, firmware version, driver version, and software version about the system, integrated modules, and attached accessories.

 **NOTE:** Tap **About** to view the application name, version number, and copyright information.

HP VoiceReply

HP VoiceReply allows you to reply or compose e-mail messages using your voice.

HP VoiceReply can also be used to:



- Reply to a sender
- Reply to all recipients
- Forward a message

You can access HP VoiceReply in three different views:

- **List View** – While reviewing a list of messages in the Inbox.
- **Read View** – While reading a particular message from the list of messages in the Inbox.
- **Compose View** – While composing a new e-mail message, replying to an e-mail message, or forwarding an e-mail message.

HP VoiceReply can be used with Outlook accounts, POP3 account, or with iMAP4 accounts from your HP iPAQ.

To use HP VoiceReply:

1. When composing a new e-mail message or replying or forwarding a message, tap **Menu > HP VoiceReply** to select either of the following options:
 - **Reply to Sender** – To send your reply only to the recipient who initially sent you the e-mail message.
 - **Reply to All** – To send your reply to all the recipients of the initial e-mail message.
 - **Forward** – To forward the initial e-mail message with your reply to any recipient.
-
-  **NOTE:** The three submenu options: **Reply to Sender**, **Reply to All**, and **Forward** are available under the List and Read views.
-
2. Next, in the recording window, tap the  (Record) button to record your message.
 3. Tap the  (Stop) button when you finish recording your message.
 4. The recorded message is automatically attached to your e-mail.
 5. Enter any short text message if required. You can also make changes to the editable fields in the e-mail.
 6. Tap **Send** to send the message to the recipient.

HP iPAQ Setup Assistant

Use **HP iPAQ Setup Assistant** to simplify configuring settings on your HP iPAQ.

HP iPAQ Setup Assistant lets you save the settings on your computer. This can help you restore configuration settings on your HP iPAQ at any time. **HP iPAQ Setup Assistant** also allows you to perform a hard reset on your HP iPAQ and view detailed product information.

Using **HP iPAQ Setup Assistant**, you can manage multiple configurations and apply them quickly to your HP iPAQ. You can create a new configuration, modify existing settings, delete a selected configuration, or apply selected settings to your HP iPAQ.

 **NOTE:** You need to install HP iPAQ Setup Assistant available on the *Getting Started* CD on your computer

Select the following tabs to configure your settings:

- **Owner Information** – Enter your identification information and notes to describe you and your HP iPAQ. This is helpful if you lose your HP iPAQ.
- **Wireless Network** – Wireless network settings describe the configuration needed to connect to your work, home, or other wireless network.
- **Proxy** – Proxy servers are located between two networks and are used to help prevent an attacker from invading a private network. You can enter proxy settings to specify the proxy configuration for your network.
- **E-mail** – E-mail settings describe the configuration required to connect to and check your Internet e-mail accounts.
- **Exchange Server** – Exchange Server is used to access e-mail, calendars, contacts, tasks, and other mailbox contents while on the go. You can set up Outlook on your HP iPAQ to synchronize directly with your organization's Exchange Server.

- **Speed Dial – HP iPAQ Setup Assistant** helps you to create and manage a list of speed dial numbers for your HP iPAQ.

 **NOTE:** The first speed dial entry is usually reserved for Voice mail by your phone service provider, and your service provider might also reserve an entry for emergency response.

- **Browser Favorite** – Use your **HP iPAQ Setup Assistant** to create and manage a list of your favorite URLs. You can access these URLs using the Internet Explorer on your HP iPAQ.
- **Finish** – In case of a new configuration, after you click **Finish**, enter a configuration name and an optional password, and then click **OK** in the save configuration. If this is an existing configuration, the existing name and password will be used.

HP Shortcuts

Use HP Shortcuts

Use **HP Shortcuts** to access a list of shortcuts to your favorite applications or features on your HP iPAQ.

To use HP Shortcuts:

1. Tap **Start > Programs > HP Shortcuts**.

 **NOTE:** You can also access the **HP Shortcuts** from the **Today** screen by pressing the right softkey.

2. Scroll and tap to select the application you want to use.

 **NOTE:** You can also access the application by pressing the number displayed next to the application name. Alternatively, use the **Smart-Touch Navigation** wheel to scroll to the application, and then press the  key on the keypad.

Edit HP Shortcuts

You can edit the default shortcuts list or create new shortcuts and store them in the existing list.

To edit a shortcut:

1. Scroll to the shortcut you want to edit in **HP Shortcuts** list and tap **Menu > Edit**.
2. To change the default shortcuts to different applications, tap **Select new target**.
3. Select **Tasks, Programs, Web Links, or File** and tap **Select**.
4. Select an application for which you want to create a shortcut.
5. The selected application is shown in the **Shortcut Name** box. Tap **Save** to save the application shortcut in the shortcut list.

 **NOTE:** To modify the name, specify a new name in the **Shortcut name** box and press **Save** to save the modified name.

HP iPAQ DataConnect

The first time you use your SIM Card, the **HP iPAQ DataConnect** application automatically detects the phone network and operator and, configures GPRS/EDGE settings.

To configure the data settings manually:

1. Tap **Start > Settings > Connections > HP iPAQ DataConnect**.
2. Select a country and operator, and then tap **Select** to configure the network settings for the selected operator.
3. The data settings will be retrieved each time you try to connect to the Internet using GPRS.

△ **CAUTION:** Editing network parameters is not recommended unless you are being assisted by your mobile phone service provider.

HP Asset Viewer

Using the **HP Asset Viewer** application, you can view information about the system, integrated modules, and attached accessories.

To access HP Asset Viewer:

1. Tap **Start > Settings > System > HP Asset Viewer**.
2. To view additional system information, tap the appropriate tabs.
 - The **Identity** tab – displays the serial number and the user information.
 - The **Memory** tab – displays the device memory size for ROM and RAM on your HP iPAQ. It also displays information about flash chip type and flash block size.
 - The **Version** tab – displays the version numbers of the ROM, OS, BootLoader, and XIP.
 - The **Display** tab – displays settings, such as screen color, size, color depth, display type, and panel type.
 - The **System** tab – displays information about manufacturer, product ID, model ID, processor type, language, and country ID.
 - The **Camera** tab – displays camera details, such as resolution, and camera drivers.
 - The **Keyboard** tab – displays the hardware version and the keyboard drivers.
 - The **Bluetooth** tab – displays the radio status of Bluetooth, firmware version, driver version, software version, and MAC address.
 - The **WLAN** tab – displays the radio status of WLAN, firmware version, driver version, software version, and MAC address.
 - The **GSM** tab – displays the phone status of GSM, the radio firmware version, and the IMEI number.
 - The **GPS** tab – displays the radio status of internal GPS and external GPS, manufacturer, firmware version, driver version, and software version.
 - The **Extended ROM** tab – displays details of the iPAQ customization software that resides on the extended ROM (not applicable to all devices).

HP CertEnroller

HP CertEnroller is an enhanced security feature for retrieving and registering new certificates. This application allows you to request a user certificate from a certificate server.

📄 **NOTE:** **HP CertEnroller** picks up certificate types from Active Directory as well as from the device data store. You must enter a server name for retrieving the certificate, and if required, a valid username and password.

To access **HP CertEnroller**:

1. Tap **Start > Settings > System > HP CertEnroller**.
2. Use the on-screen keypad to enter server name, user name, and password. Tap **Retrieve** to initiate the transaction of downloading the certificate from the server.
3. Once the certificate is retrieved, tap **Menu > Cancel** to exit.

 **NOTE:** Tap **Menu > About** to view a brief description of the application, application name, version number, and copyright statement. On the **Enroll Certificates** screen, tap **Start > Help** for more information about the Certificate Enroller application.

HP iPAQ Tips



HP iPAQ Tips displays tips to perform operations on your HP iPAQ in a quick and efficient way. A tip is displayed on your screen every time you turn on your HP iPAQ. Tap **Menu > Next** to display the next tip. To quit the application, tap **Dismiss**. You can also access **HP iPAQ Tips** by tapping **Start > Programs > HP Help and Support > HP iPAQ Quick Tips**.

 **TIP:** You can also access the **HP iPAQ Tips** application by tapping **Start > Programs > HP iPAQ Tips**.

HP iPAQ Mobile Broadband Connect

Use **HP iPAQ Mobile Broadband Connect** to connect your computer to the Internet using your data and Wi-Fi enabled iPAQ. Visit <http://hp.com/go/mobilebroadbandconnect> to download the application and the instructions.

HP Enterprise Mobility Agent

The  **HP Enterprise Mobility Agent** is part of the **HP Enterprise Mobility Suite** which helps you easily configure and manage your HP iPAQ remotely. The  **HP Enterprise Mobility Agent** must be activated remotely by a licensed **HP Enterprise Mobility server** which is sold separately. Visit <http://www.hp.com/go/ems> for more information or contact your IT administrator to check if your company is currently using the **HP Enterprise Mobility Suite**. The **HP Enterprise Mobility Suite** provides the ability to remotely configure mobile services, diagnose the device, add/remove applications, and lock/unlock/wipe the device in the case it is lost or stolen.

HP iPAQ File Store

You can install programs and save files to the iPAQ File Store folder, which can be accessed from the **File Explorer** on your HP iPAQ. Programs and files stored on your iPAQ File Store folder are not deleted even if you perform a full reset on your HP iPAQ.

To save files to the HP iPAQ File Store:

1. Copy the files to be saved to the iPAQ File Store folder.
2. Tap **Start > Programs > File Explorer > iPAQ File Store**.
3. Tap **Edit > Paste**.

 **CAUTION:** iPAQ File Store may contain a special folder called hp to store system files. Do not save new files or modify existing files in the hp folder.



 **NOTE:** Before saving files to the iPAQ File Store folder, it is a good idea to determine how much memory is available in the folder. To view the amount of memory, tap **Start > Settings > System > Memory > Storage Card**, and then select **iPAQ File Store** from the list.

HP iPAQ Ring Tone Manager

With **HP iPAQ Ring Tone Manager** application, you can add and remove ring tones on your HP iPAQ.

To add a ring tone:

1. Tap **Start > Settings > System > RingTones > Add**.
2. On the **iPAQ Ring Tones** screen, under **Select Ring Tones to add to your device**, all *.wav, *.mid, and *.mp3 files stored on the device are displayed.
3. Select the required ring tones, and tap **Add**.

To play the newly added ring tones, tap the  (Play) button. Use the  (Stop) button, to stop the ring tone being played.

To remove a ring tone:

1. Tap **Start > Settings > System > RingTones > Remove**.
2. On the **iPAQ Ring Tones** screen, under **Select Ring Tones to be removed from your device** list, select the required ring tones.
3. Tap **Remove**.

 **NOTE:** You can use the **HP iPAQ Ring Tone Manager** application only to add and remove ring tones. This application lacks the ability to assign any file as a current ring tone.

Manage certificates

To manage certificates:

1. Tap **Start > Settings > System > Certificates**.
2. Select a certificate tab.
 - The **Personal** tab displays your personal certificates.
 - The **Intermediate** tab displays the intermediate certification authorities.
 - The **Root** tab displays the root certification authorities.

 **NOTE:** To view the certificate details, tap the required certificate on each tab.

iPAQ Audio

iPAQ Audio allows you to set, adjust, and save settings for the audio output and microphone.

To configure the audio output settings:

1. Tap **Start > Settings > System > iPAQ Audio > Audio out**.
2. Move the **Bass Boost** slider to make changes to the bass level and the **Treble Adjustment** slider to adjust the treble effect.
3. Tap **Restore Default** to switch to original settings.

To access the microphone settings:

1. Tap **Start > Settings > System > iPAQ Audio > Mic**.
2. On the **Microphone** screen, clear the **Enable AGC** check box to activate the microphone settings.
 **NOTE:** If you enable the Automatic Gain Control (AGC), the system handles the gain level.
3. Select one of the predefined modes: **Quiet**, **Normal**, or **Noisy**.
4. Use the slider to adjust the set value of each of these modes.

Keyguard

The **Keyguard** application deactivates your iPAQ touch screen and keys to prevent accidental activation of the device or any of its functions.

To enable the **Keyguard** application, tap **Start > Settings > Personal > Buttons > Lock > Enable Keyguard > ok**.

 **NOTE:** Once the device enters standby mode, the keyguard is automatically activated.

To disable the **Keyguard** application, clear the **Enable Keyguard** check box and tap **ok**.

The buttons on the device do not perform their functions and the touch screen is inactive until you complete the sequence to unlock the keys. To unlock this application, follow the deactivation sequence as described on the screen.

 **NOTE:** When you receive a call, the keyguard remains active and allows you to answer the call.

NOTE: To dial an emergency number when the keyguard is active, enter the emergency number using the keypad and press the  (Answer/Send) key.

Voice Commander

Use **Voice Commander** application to look up contacts, dial a contact by name, get calendar information, play and control your music, as well as launch applications on your HP iPAQ. For more information refer [Voice commands on page 24](#).

 **TIP:** You can also access the **Voice Commander** application by tapping **Start > Programs > Voice Commander** or you can also press the **Voice Commander** key on the right panel of your HP iPAQ.

Internet Explorer

You can launch the **Internet Explorer** application from the **Start** menu. This application displays an iPAQ-customized home page with the following options:

- **iPAQ software** – Download software and game for your mobile device. Browse the site for the newest updates and best software.
- **iPAQ Mobile** – Use this site for products, support, and other iPAQ information.
- **Windows Mobile** – Learn more about Windows Mobile software
- **iPAQ accessories** – Buy HP iPAQ handheld accessories direct from the HP Home & Home Office Store.
- **HP shopping** – Buy desktops, laptops, printers, digital cameras, televisions, and ink and toner cartridges direct from HP.

 **NOTE:** These options vary by country/region.

Each icon is linked to its respective Web page. Therefore, the appropriate Web page opens up when you tap a desired icon.

Remote Desktop Mobile

Use the **Remote Desktop Mobile** to log on to a Windows Terminal Server. This facility allows you to use all programs installed on this server.

To connect to a Terminal Server:

1. Tap **Start > Programs > Remote Desktop Mobile**.
2. In the **Computer** box, enter a Terminal Server name or TCP/IP address.
3. Enter your user name, password, and domain in the respective boxes.
4. Tap **Connect**.

Tap **Options > Display** to set the color options, **256 Colors** or **High Color (16 bit)**. You can view the **Remote desktop display** either in the full screen mode or you can choose to fit the remote desktop to your iPAQ screen.

 **NOTE:** After you connect to a terminal server, press the **Right** softkey to select the **Full Screen** option.

Tap **Options > Sound** to set the **Remote desktop sound**. You can either select to mute the sound, play the sound on the remote computer, or play the sound on your device.

Windows Media Player

Use Windows Media Player to enjoy your digital media in new ways both at home and on the go. Using Windows Media Player, you can play audio and video files stored on your phone or memory card.

Tap **Start > Programs > Windows Media** to open the Windows Media Player application.

For a complete list of features and more, visit <http://www.microsoft.com/windowsmedia>.

 **NOTE:** Protected files are digital media files that are secured with a license to prevent unauthorized use or playback. Licenses are created and managed by using the DRM technology. Your HP iPAQ supports OMA 1.0 forward lock DRM version.

Clear the Now Playing List

Tap **Start > Programs > Windows Media** and select **Now Playing**.

The **Now Playing** playlist displays the currently playing file and any files that are queued up to play next. You can quickly remove all items from the playlist by clearing the **Now Playing** playlist.

To clear the **Now Playing** list:

1. If you are on the **Library** screen, select the **Now Playing** category to display the **Now Playing** screen. If you are on the **Playback** screen, select **Now Playing** to display the **Now Playing** screen.
2. On the **Now Playing** screen, tap **Menu > Clear Now Playing**.

Update a Library

In most cases, Windows Media Player Mobile automatically updates your libraries. However, you can manually update a library to ensure that it has links to any new files that you might have recently copied to your HP iPAQ or a removable storage card.

To update a library:

1. If you are not already on the **Library** screen, tap **Menu > Library...**
2. On the **Library** screen, tap **Menu > Update Library...**
3. Wait for the files to be added, and then tap **Done**.

Use Voice Commander to play media files

You can play your media files by using the **Voice Commander** application on your HP iPAQ.

1. Press the **Voice Commander** key on your HP iPAQ.
2. Hold your HP iPAQ 10 cm away from your face and say **Play Music (Media File Name)** to play the media file.

 **NOTE:** The **Play Music** voice command will only play media files present in a playlist.

NOTE: Press the **Voice Commander** key and say **Pause/Resume Music** to pause or resume the media file.

Office Mobile applications

Word Mobile

You can create and edit documents and templates in **Word Mobile**. You can also save the documents and templates as .doc, .rtf, .txt, and .dot files.

With Word Mobile, you can:

- Edit word documents and templates created on your computer.
- Open and edit Pocket Word (*.psw) documents

 **NOTE:** If you edit a file, you will need to save it in .doc, .rtf, .txt, or .dot format.

To access **Word Mobile**, tap **Start > Office Mobile > Word Mobile**.

Options available when you tap **Menu** allow you to:

- Create a new document or edit an existing document.
- Format a document.
- Check spellings and count words in a document.
- Save, move, rename, or delete a document.
- Send a document via e-mail or Bluetooth.

Excel Mobile

You can create and edit workbooks and templates on your HP iPAQ with **Excel Mobile**.

With Excel Mobile, you can:

- View, edit, and create charts and graphics, which can be embedded as objects in a worksheet or placed on a separate worksheet.
- Enter formulas and functions, and then filter data to see the subset of information you want.
- Split panes to view different parts of a worksheet at the same time.
- Freeze the top and left-most panes in a worksheet to keep row and column labels or other data visible as you scroll through a sheet.

To access **Excel Mobile**, tap **Start > Office Mobile > Excel Mobile**.

To access options for organizing and formatting a worksheet, open a worksheet and tap **Menu**. In addition to **Cut**, **Copy**, and **Paste**, there are options in **Menu** that allow you to:

- Paste cells using **Paste Special...**
- Clear cell contents and formats applied to cells.
- Insert new cells, charts, symbols, functions, and define names in a workbook.
- Set dimensions for rows and columns. Align cells, set font and style for the text, and set cell borders.
- Create new worksheets and save, rename, or delete existing worksheets.
- Send a worksheet through e-mail or Bluetooth.

PowerPoint Mobile

Use **PowerPoint Mobile** to open and view slide show presentations created on your computer.

With PowerPoint Mobile, you can:

- Open a presentation from an e-mail message.
- Download a presentation from a file share or the Internet.
- Copy a presentation to your HP iPAQ via a storage card.

 **NOTE:** Slide shows created in *.ppt or *.pps format with PowerPoint '97 and later can be viewed on your device.

PowerPoint features that are not supported on your HP iPAQ include:

- Notes: Notes written for slides are not visible.
- Rearranging or editing slides: **PowerPoint Mobile** is a viewer only.

To access **PowerPoint Mobile**, tap **Start > Office Mobile > PowerPoint Mobile**.

Options available when you tap **Menu** allow you to:

- Set up a slide show.
- Rename, move, delete, or create a copy of a presentation.
- Send a presentation via e-mail or Bluetooth.

Games

Bubble Breaker

The objective of **Bubble Breaker** is to have balls (more than one) of the same color deleted from the screen. The fewer balls you leave behind, the higher your score will be.

To start a new game:

1. Tap **Start > Programs > Games > Bubble Breaker**.
2. Tap **New Game** to start a new game.

 **NOTE:** You can continue playing an existing game.

3. Tap **Menu > Statistics** to select a style to display relative entries.
4. Tap **Menu > Options...** to edit the settings for the game.

 **NOTE:** To recall the balls you deleted, tap **Menu > Undo Move**.

To play a game:

1. Tap **Start > Programs > Games > Bubble Breaker**.
2. Tap **New Game** to start a new game.
3. Tap a ball which is of the same color as the other balls around.
4. Tap the similar colored balls twice to delete the balls from the screen.

Solitaire

The objective of **Solitaire** is to use all the cards in the deck to build up four suit stacks in ascending order, beginning with the aces. You win the game when all cards are on the suit stacks.

To play a game:

1. Tap **Start > Programs > Games > Solitaire**.
2. Tap **Menu > New Game** to start a new game.
3. Tap and hold the card you want to move and drag it to the card stack to which you want to move the card.
4. Move any aces on the seven stacks to the four card spaces at the top of the screen, and then make any other available plays.
5. Tap a card twice to move it to the four card stack on the upright corner of the screen if it belongs there. The card that is faced up on the four card stacks is always available for play.
6. When you have made all the available plays, tap **Draw** to turn over cards.

Internet Sharing

You can use your HP iPAQ as a wireless modem. The **Internet Sharing** software on your HP iPAQ guides you during the connection process. Insert a data-enabled SIM into your HP iPAQ before setting up **Internet Sharing**. You might also need to install the software drivers (located on the *Getting Started* CD) on to your laptop. Before you can begin **Internet Sharing**, make sure you have a cellular connection. If you do not have an active connection, you will not be able to launch the **Internet Sharing** application.

To connect to a laptop using a USB data connection

You might need to install the USB driver before connecting to your computer. If your computer has automatically added your HP iPAQ as a new modem, you can skip the following steps:

1. Connect your HP iPAQ to the computer using the mini-USB synchronization cable (WMDC for Windows Vista and ActiveSync for Windows XP). Your computer might prompt you for the wireless USB modem driver with a **New hardware wizard** menu screen. Else proceed to **To set up a USB modem connection**.
2. Click **Next** on the welcome screen of the **Install Wizard**.
3. Select the **Search for a suitable driver for my device (recommended)** option.
4. Select **Specify a Location** and browse to the C:\ drive folder that contains the USB driver.

 **NOTE:** Click **Next** to allow your computer to automatically search and download the USB driver file.

5. Click **Finish**.
6. After installing the driver, **Smartphone USB Modem** will be added to the device list in the Device Manager.
7. Next, disconnect your HP iPAQ from the computer.

 **NOTE:** 56 K modems are capable of receiving 56 Kbps from a compatible service provider. Actual speeds will vary depending on line conditions.

To set up a USB modem connection:

1. Make sure that your HP iPAQ is not connected to your computer.
2. Tap **Start > Programs > Internet Sharing**.
3. Scroll and select **USB** from the **PC Connection** list.
4. Scroll and select the type of GPRS connection you want to use from the **Network Connection** list.
5. Now connect your HP iPAQ to your computer with the mini-USB synchronization cable and tap **Connect**.

To connect to a laptop using Bluetooth data connection

For best results, connect your HP iPAQ to the computer using a mini-USB (WMDC for Windows Vista and ActiveSync for Windows XP) to establish a synchronization relationship before connecting via Bluetooth.

- Follow the instructions on your synchronization software help for configuring Bluetooth on your computer.

To set up a Bluetooth modem connection:

1. Make sure that your HP iPAQ is not connected to your computer.
2. Tap **Start > Programs > Internet Sharing**.
3. Scroll and select **Bluetooth PAN** from the **PC Connection** list.
4. Scroll and select the type of GPRS connection you want to use from the **Network Connection** list.

5. Make your HP iPAQ visible and detectable. Connect the Bluetooth PAN to your computer and create a partnership between them.
6. Press **Connect** after the partnership is established.

Internet Explorer

Use **Internet Explorer Mobile** to view and download Web pages as well as browse Web sites through synchronization, or when connected to the Internet. The **HP iPAQ DataConnect** application detects the network settings and lets you connect to Internet Web sites.

To open a link using favorite page:

1. Tap **Start > Internet Explorer** to open the **Internet Explorer Mobile**.
2. Tap **Favorites** list and tap to open the required link.
3. Tap **Menu > Favorites...** to list all your favorite sites and tap **Menu > Add To Favorites...** to add a new URL in your favorites list.
4. Tap **Menu > History...** to display the history.

 **NOTE:** Tap **Menu > Tools > Options...** to change general, memory, and security settings.

NOTE: You can send any URL as an e-mail message by tapping **Menu > Tools > Send Link...**

You can learn more about Internet Explorer by tapping **Start > Help > Contents > Browse the Web**.

Windows Live Messenger

You can use Windows Live Messenger on your phone to send instant messages. Windows Live Messenger provides the same chat environment as of the Windows Live Messenger on your computer.

With the Windows Live Messenger feature, you can:

- Send and receive Instant Messages.
- Change your own status or view the status of others on your list.
- Invite others for a chat conversation.
- Block certain contacts from seeing your status or sending you messages.

Tap **Start > Programs > Messenger** to open the Windows Live Messenger application.

To use Windows Live Messenger, you need a Microsoft.NET Passport account unless you already have a Hotmail account. To set up a Microsoft.NET Passport account, go to <http://www.passport.net>. After you have an account, you can use your Windows Live Messenger feature.

Sign in and out of messenger

Tap **Start > Programs > Messenger** to open Windows Live Messenger feature.

To sign into the Messenger:

1. Tap **Sign in** after navigating to a required sign-in status.
2. Enter your information in the **Sign-in** and **Password** box. Tap **Sign In**.

To sign out of the Windows Live Messenger:

- Tap **Menu > Sign Out** to sign-out of Windows Live Messenger.

If you do not sign out of Windows Live Messenger, you remain on a data connection, which might result in additional charges from your service provider. The session will not time out or end unless one of the following occurs:

- User ends instant messenger session
- User accepts an incoming voice call
- An outgoing voice call is placed
- The device is turned off or moves out of range

Send instant messages

You can send instant messages from your Windows Live Messenger to contacts on your messenger list.

To send instant messages:

1. Select the person to whom you want to send an instant message and tap **Send**.
2. Enter your message, and tap **Send**.

You can also manage your contacts and control their visibility.

To manage contacts in the Windows Live Messenger:

- Tap **Menu > Add New Contacts** to create a new contact.
- Tap **Menu > Contact Options > Delete** to delete an existing contact.
- Tap **Menu > Block/Unblock** to block or unblock the selected contact from seeing your status and sending you instant messages.

 **NOTE:** Tap **Menu > My Text** to add common messages when composing instant messages. Tap **Menu > Invite** to invite a contact to an ongoing chat. You can also see who is already talking to you or change between chats by tapping **Menu > Chats**.

Change your status

You can change your status on Windows Live Messenger according to your need. To change your status:

1. Tap and select your name in the contact list.
2. Press **Menu > Change Appearances**, and navigate to select the required status.

SMS cell broadcast

Short Message Service Cell Broadcast (SMS-CB) allows messages to reach multiple mobile phones at once. The messages can be sent to specific cells or to a specific geographical area.

SIM Toolkit

SIM Toolkit (STK) consists of a set of commands that are programmed into the SIM card. The toolkit defines how the card should interact with the outside world and extends the communication protocol between the card and the handset. It supports various value added services typically provided by the operator or third party companies.

SIM Manager

SIM Manager supports various SIM card features and allows the user to access information on the SIM card. It also allows users to manage the SIM card security features and contacts.

Power

Using the **Power** application you can view the amount of battery power remaining. The **Power** application also enables you to set the standby period, duration for turning off, and USB charging speed for your HP iPAQ.

To change power settings:

1. Tap **Start > Settings > System > Power**.
2. Tap **Advanced** and select the length of time the HP iPAQ stays on when using battery power or AC power.
3. Tap **USB Charging** and select the **Use USB Charging** check box to enable USB charging.

Select any of the following options:

- **Fast Charging**
- **Slow Charging**

Backlight

The **Backlight** application enables you to view and change the backlight options, such as brightness of your HP iPAQ.

To change backlight settings:

1. Tap **Start > Settings > System > Backlight**.
2. Tap **Battery power** or **External Power**. Select the **Turn off backlight if device is not used for** check box and select the duration from the list.

Tap **Start > Settings > System > Backlight > Brightness**. Next, move the slider on the **Backlight** screen up or down to set the required level of brightness.

 **TIP:** You can also use the **3-Way Thumb-Wheel** or the **Smart-Touch Navigation** wheel to move the slider.

19 Product specifications

System specifications

 **NOTE:** Not all models described are available in all countries/regions. For more information on specifications for your particular model, on your HP iPAQ, tap **Start > Settings > System > HP Asset Viewer**.

System Feature	Description
Processor	Marvell PXA270, 520 MHz
Operating System	Microsoft® Windows Mobile 6 Professional
Memory	128 MB SDRAM/256 MB Flash ROM
External Power	Power adapter: input 100–240 Vac, 200 mA, 50 to 60 Hz and output +5 Vdc, 1 A USB charger: 5 Vdc, 100/500 mA
Display	2.8" 240x320 TFT LCD with touch screen
SD Slot	Supports MicroSD memory
Headphone Jack	Microphone input jack, combined with headphone jack
Antenna	Internal Wi-Fi and Bluetooth antennas NOTE: This component will not be visible externally.
Battery	1590 mAh Li-polymer removable/rechargeable battery
Bluetooth	10 m range (approximately 33 ft) – High-speed, low-power, short-range wireless communication with other Bluetooth devices
Wi-Fi	IEEE 802.11b/g
Camera	<ul style="list-style-type: none">• 3 Megapixels• Auto-focus (10 cm to infinity)• 4x Digital Zoom• Video recording with audio (max. QVGA) NOTE: The camera is not available on all models.

Physical specifications

	US	Metric
Length	4.61 inches	117 mm
Width	2.37 inches	60.3 mm

	US	Metric
Depth	0.69 inches	17.5 mm
Weight	<ul style="list-style-type: none"> • With battery: 5.1 oz • Without battery: 4.021 oz 	<ul style="list-style-type: none"> • With battery: 145 g • Without battery: 114 g

Operating environment

		US	Metric
Temperature	Operating	14° to 131° F	-10° to 55° C
	Non-operating	4° to 140° F	-20° to 60° C
Relative Humidity	Operating	85 % RH	85 % RH
	Non-operating	90 % RH	90 % RH

20 Regulatory notices

Federal Communications Commission Notice

This equipment has been tested and found to comply with the limits for a Class B digital device, pursuant to Part 15 of the FCC Rules. These limits are designed to provide reasonable protection against harmful interference in a residential installation. This equipment generates, uses, and can radiate radio frequency energy and, if not installed and used in accordance with the instructions, may cause harmful interference to radio communications. However, there is no guarantee that interference will not occur in a particular installation.

If this equipment does cause harmful interference to radio or television reception, which can be determined by turning the equipment off and on, the user is encouraged to try to correct the interference by one or more of the following measures:

- Reorient or relocate the receiving antenna.
- Increase the separation between the equipment and receiver.
- Connect the equipment to an outlet on a circuit different from that to which the receiver is connected.
- Consult the dealer or an experienced radio or television technician for help.

Modifications

The FCC requires the user to be notified that any changes or modifications made to this device that are not expressly approved by HP may void the user's authority to operate the equipment.

Cables

To maintain compliance with FCC Rules and Regulations, connections to this device must be made with shielded cables having metallic RFI/EMI connector hoods.

Declaration of Conformity for Products Marked with the FCC Logo (United States Only)

This device complies with Part 15 of the FCC Rules. Operation is subject to the following 2 conditions:

1. This device may not cause harmful interference.
2. This device must accept any interference received, including interference that may cause undesired operation.

If you have questions about the product that are *not* related to this declaration, write to

Hewlett-Packard Company

P. O. Box 692000, Mail Stop 530113

Houston, TX 77269-2000

or call 1-800-HP-INVENT (1-800-474-6836)

For questions regarding this FCC declaration, write to

Hewlett-Packard Company

P. O. Box 692000, Mail Stop 510101

Houston, TX 77269-2000

or call HP at 281-514-3333

To identify your product, refer to the part, series, or model number located on the product.

Canadian Notice

This Class B digital apparatus meets all requirements of the Canadian Interference-Causing Equipment Regulations.

Avis Canadien

Cet appareil numérique de la classe B respecte toutes les exigences du Règlement sur le matériel brouilleur du Canada.

European Union Notice

Products bearing the CE marking comply with the following EU Directives:

- Low Voltage Directive 2006/95/EC
- EMC Directive 2004/108/EC

CE compliance of this product is valid only if powered with the—correct CE—marked AC adapter provided by HP.

If this product has telecommunications functionality, it also complies with the essential requirements of the following EU Directive:

- R&TTE Directive 1999/5/EC

Compliance with these directives implies conformity to harmonized European standards (European Norms) that are listed in the EU Declaration of Conformity issued by HP for this product or product family. This compliance is indicated by one of the following conformity markings placed on the product.

- This CE marking is valid for non-telecommunications products and for EU harmonized telecommunications products, such as Bluetooth®.



- This CE marking is valid for EU non-harmonized telecommunications products.



*If applicable, a notified body number is used. Refer to the regulatory label provided on this product.

Hewlett-Packard GmbH, HQ-TRE, Herrenberger Strasse 140, D-71034 Böblingen, Germany

The telecommunications functionality of this product may be used in the following EU and EFTA countries:

Austria, Belgium, Bulgaria, Cyprus, Czech Republic, Denmark, Estonia, Finland, France, Germany, Greece, Hungary, Iceland, Ireland, Italy, Latvia, Liechtenstein, Lithuania, Luxembourg, Malta, Netherlands, Norway, Poland, Portugal, Romania, Slovak Republic, Slovenia, Spain, Sweden, Switzerland, and United Kingdom.

Products with 2.4–GHz Wireless LAN Devices

France

L'utilisation de cet équipement (2.4GHz Wireless LAN) est soumise a certaines restrictions: Cet équipement peut être utilisé a l'interieur d'un batiment en utilisant toutes les frequences de 2400 a 2483.5MHz (Chaîne 1-13). Pour une utilisation en environnement exterieur, les frequences comprises entre 2400-2454 MHz (Chaîne 1-9) peuvent être utilisé. Pour les dernieres restrictions, voir <http://www.arcep.fr>.

For 2.4 GHz Wireless LAN operation of this product certain restrictions apply: This product may be used indoors for the entire 2400–2483.5 MHz frequency band (channels 1–13). For outdoor use, only 2400–2454 MHz frequency band (channels 1–9) may be used. For the latest requirements, see <http://www.arcep.fr>.

Italy

E' necessaria una concessione ministeriale anche per l'uso del prodotto. Verifici per favore con il proprio distributore o direttamente presso la Direzione Generale Pianificazione e Gestione Frequenze.

License required for use. Verify with your dealer or directly with the General Direction for Frequency Planning and Management (Direzione Generale Pianificazione e Gestione Frequenze).

Battery Warning

-
- ⚠ **WARNING! BATTERY PACKAGE** This HP iPAQ contains a lithium ion rechargeable battery. To reduce the risk of fire or burns, do not disassemble, crush, puncture, short external contacts, or dispose of in fire or water. Replace only with the HP spare.
 - ⚠ **CAUTION:** Risk of explosion if battery is replaced by an incorrect type. Dispose of used batteries according to the instructions.
-

Battery Recycling

HP encourages customers to recycle used electronic hardware, HP original print cartridges, and rechargeable batteries. For more information about recycling programs, visit <http://www.hp.com/recycle>.

Battery Disposal

-
- ⚠ **WARNING!** When a battery has reached the end of its useful life, do not dispose of the battery in general household waste. Follow the local laws and regulations in your area for computer battery disposal.
-



Disposal of Waste Equipment by Users in Private Household

Disposal of Waste Equipment by Users in Private Household in the European Union



This symbol on the product or on its packaging indicates that this product must not be disposed of with your other household waste. Instead, it is your responsibility to dispose of your waste equipment by handing it over to a designated collection point for the recycling of waste electrical and electronic equipment. The separate collection and recycling of your waste equipment at the time of disposal will help to conserve natural resources and ensure that it is recycled in a manner that protects human health and the environment. For more information about where you can drop off your waste equipment for recycling, please contact your local city office, your household waste disposal service or the shop where you purchased the product.

التخلص من مخلفات الأجهزة من قبل المستخدمين في منازلهم الخاصة في الاتحاد الأوروبي



يشير هذا الرمز على المنتج أو على علبته إلى أنه يجب عدم التخلص من هذا المنتج مع باقي النفايات المنزلية. عوضاً عن ذلك، تقع على عاتقك مسؤولية التخلص من مخلفات الأجهزة بتسليمها لمركز الجمع المعين لغرض إعادة تصنيع المخلفات من الأجهزة الكهربائية والإلكترونية ويؤدي جمع مخلفات الأجهزة وإعادة تصنيعها، عندما يحين أو أن التخلص منها، إلى مساعدتك في المحافظة على الموارد الطبيعية ويضمن إعادة تصنيعها بشكل يحمي الصحة البشرية والبيئة للحصول على معلومات حول أماكن تسليم مخلفات الأجهزة بغرض إعادة تصنيعها، يرجى الاتصال بمكتب البلدية المحلية، أو خدمة جمع النفايات المنزلية أو المتجر حيث اشتريت المنتج.

Likvidace zařízení soukromými domácími uživateli v Evropské unii



Tento symbol na produktu nebo balení označuje výrobek, který nesmí být vyhozen spolu s ostatním domácím odpadem. Povinností uživatele je předat takto označený odpad na předem určené sběrné místo pro recyklaci elektrických a elektronických zařízení. Okamžité třídění a recyklace odpadu pomůže uchovat přírodní prostředí a zajistí takový způsob recyklace, který ochrání zdraví a životní prostředí člověka. Další informace o možnostech odevzdání odpadu k recyklaci získáte na příslušném obecním nebo městském úřadě, od firmy zabývající se sběrem a svozem odpadu nebo v obchodě, kde jste produkt zakoupili.

Bortskaffelse af brugt udstyr hos brugere i private hjem i EU



Dette symbol på produktet eller på emballagen angiver, at dette produkt ikke må bortskaffes sammen med det øvrige husholdningsaffald. I stedet er det dit ansvar at bortskaffe dit brugte udstyr ved at aflevere det ved et autoriseret indsamlingssted med henblik på genbrug af elektrisk og elektronisk udstyr. Den særskilte indsamling og genbrug af dit brugte udstyr i forbindelse med bortskaffelsen er med til at bevare naturlige ressourcer og sikre, at udstyret genbruges på en måde, som beskytter helbred og miljø. Yderligere oplysninger om steder, hvor du kan aflevere dit brugte udstyr med henblik på genbrug, kan du få på dit lokale kommunekontor, hos renovationsfirmaet for dit lokalområde eller den butik, hvor du købte produktet.

Seadmete jäätmete kõrvaldamine eramajapidamistes Euroopa Liidus



See tootel või selle pakendil olev sümbol näitab, et kõnealust toodet ei tohi koos teiste majapidamisjäätmetega kõrvaldada. Teie kohus on oma seadmete jäätmed kõrvaldada, viies need elektri- ja elektroonikaseadmete jäätmete ringlussevõtmiseks selleks ettenähtud kogumispunkti. Seadmete jäätmete eraldi kogumine ja ringlussevõtmise kõrvaldamise ajal aitab kaitsta loodusvarasid ning tagada, et ringlussevõtmise toime viisil, mis kaitseb inimeste tervist ning keskkonda. Lisateabe saamiseks selge kohta, kuhu oma seadmete jäätmed ringlussevõtmiseks viia, võtke palunühendust oma kohaliku linnakantselei, majapidamisjäätmete kõrvaldamise teenistuse või kauplusega, kust Te toote ostsite.

Laitteiden hävittäminen kotitalouksissa Euroopan unionin alueella



Jos tuotteessa tai sen pakkauksessa on tämä merkki, tuotetta ei saa hävittää kotitalousjätteiden mukana. Tällöin hävitettävä laite on toimitettava sähkölaitteiden ja elektronisten laitteiden kierrätyspisteeseen. Hävitettävien laitteiden erillinen käsittely ja kierrätys auttavat säästämään luonnonvaroja ja varmistamaan, että laite kierrätetään tavalla, joka estää terveyshaitat ja suojelee luontoa. Lisätietoja paikoista, joihin hävitettävät laitteet voi toimittaa kierrätettäväksi, saa ottamalla yhteyttä jätehuoltoon tai liikkeeseen, josta tuote on ostettu.

Élimination des appareils mis au rebut par les ménages dans l'Union européenne



Le symbole apposé sur ce produit ou sur son emballage indique que ce produit ne doit pas être jeté avec les déchets ménagers ordinaires. Il est de votre responsabilité de mettre au rebut vos appareils en les déposant dans les centres de collecte publique désignés pour le recyclage des équipements électriques et électroniques. La collecte et le recyclage de vos appareils mis au rebut indépendamment du reste des déchets contribue à la préservation des ressources naturelles et garantit que ces appareils seront recyclés dans le respect de la santé humaine et de l'environnement. Pour obtenir plus d'informations sur les centres de collecte et de recyclage des appareils mis au rebut, veuillez contacter les autorités locales de votre région, les services de collecte des ordures ménagères ou le magasin dans lequel vous avez acheté ce produit.

Entsorgung von Altgeräten aus privaten Haushalten in der EU



Das Symbol auf dem Produkt oder seiner Verpackung weist darauf hin, dass das Produkt nicht über den normalen Hausmüll entsorgt werden darf. Benutzer sind verpflichtet, die Altgeräte an einer Rücknahmestelle für Elektro- und Elektronik-Altgeräte abzugeben. Die getrennte Sammlung und ordnungsgemäße Entsorgung Ihrer Altgeräte trägt zur Erhaltung der natürlichen Ressourcen bei und garantiert eine Wiederverwertung, die die Gesundheit des Menschen und die Umwelt schützt. Informationen dazu, wo Sie Rücknahmestellen für Ihre Altgeräte finden, erhalten Sie bei Ihrer Stadtverwaltung, den örtlichen Müllentsorgungsbetrieben oder im Geschäft, in dem Sie das Gerät erworben haben.

Απόρριψη άχρηστου εξοπλισμού από χρήστες σε ιδιωτικά νοικοκυριά στην Ευρωπαϊκή Ένωση



Το σύμβολο αυτό στο προϊόν ή τη συσκευασία του υποδεικνύει ότι το συγκεκριμένο προϊόν δεν πρέπει να διατίθεται μαζί με τα άλλα οικιακά σας απορρίμματα. Αντίθετα, είναι δική σας ευθύνη να απορρίψετε τον άχρηστο εξοπλισμό σας παραδίδοντάς τον σε καθορισμένο σημείο συλλογής για την ανακύκλωση άχρηστου ηλεκτρικού και ηλεκτρονικού εξοπλισμού. Η ξεχωριστή συλλογή και ανακύκλωση του άχρηστου εξοπλισμού σας κατά την απόρριψη θα συμβάλει στη διατήρηση των φυσικών πόρων και θα διασφαλίσει ότι η ανακύκλωση γίνεται με τρόπο που προστατεύει την ανθρώπινη υγεία και το περιβάλλον. Για περισσότερες πληροφορίες σχετικά με το πού μπορείτε να παραδώσετε τον άχρηστο εξοπλισμό σας για ανακύκλωση, επικοινωνήστε με το αρμόδιο τοπικό γραφείο, την τοπική υπηρεσία διάθεσης οικιακών απορριμμάτων ή το κατάστημα όπου αγοράσατε το προϊόν.

Készülékek magánháztartásban történő selejtezése az Európai Unió területén



A készüléken, illetve a készülék csomagolásán látható azonos szimbólum annak jelzésére szolgál, hogy a készülék a selejtezés során az egyéb háztartási hulladéktól eltérő módon kezelendő. A vásárló a hulladékká vált készüléket köteles a kijelölt gyűjtőhelyre szállítani az elektromos és elektronikai készülékek újrahasznosítása céljából. A hulladékká vált készülékek selejtezési begyűjtése és újrahasznosítása hozzájárul a természeti erőforrások megőrzéséhez, valamint biztosítja a selejtezett termékek környezetre és emberi egészségre nézve biztonságos feldolgozását. A begyűjtés pontos helyéről bővebb tájékoztatást a lakhelye szerint illetékes önkormányzattól, az illetékes személtakarító vállalattól, illetve a terméket elárúsító helyen kaphat.

Smaltimento delle apparecchiature da parte di privati nel territorio dell'Unione Europea



Questo simbolo presente sul prodotto o sulla sua confezione indica che il prodotto non può essere smaltito insieme ai rifiuti domestici. È responsabilità dell'utente smaltire le apparecchiature consegnandole presso un punto di raccolta designato al riciclo e allo smaltimento di apparecchiature elettriche ed elettroniche. La raccolta differenziata e il corretto riciclo delle apparecchiature da smaltire permette di proteggere la salute degli individui e l'ecosistema. Per ulteriori informazioni relative ai punti di raccolta delle apparecchiature, contattare l'ente locale per lo smaltimento dei rifiuti, oppure il negozio presso il quale è stato acquistato il prodotto.

Vartotojų iš privačių namų ūkių atliekų šalinimas Europos Sąjungoje



Šis simbolis ant gaminio arba jo pakuotės rodo, kad šio gaminio šalinti kartu su kitomis namų ūkio atliekomis negalima. Šalintinas atliekas privalote pristatyti į specialią surinkimo vietą elektros ir elektroninės atliekoms perdirbti. Atskirai surenkamos ir perdirbamos šalintinos atliekos padės saugoti gamtinius išteklius ir užtikrinti, kad jos bus perdirbtos tokiu būdu, kuris nekenkia žmonijos sveikatai ir aplinkai. Jeigu norite sužinoti daugiau apie tai, kur galima pristatyti perdirbtinas atliekas, kreipkitės į savo seniūniją, namų ūkio atliekų šalinimo tarnybą arba parduotuvę, kurioje įsigijote gaminį.

Nolietotu iekārtu iznīcināšanas noteikumi lietotājiem Eiropas Savienības privātajās



Šāds simbols uz izstrādājuma vai uz tāiesaiņojuma norāda, ka šo izstrādājumu nedrīkst izmest kopā ar citiem sadzīves atkritumiem. Jūs atbildat par to, lai nolietotās iekārtas tiktu nodotas speciāli iekārtotos punktus, kas paredzēti izmantoto elektrisko un elektronisko iekārtu savākšanai otrreizējai pārstrādei. Atsevišķi nolietoto iekārtu savākšana un otrreizējā pārstrāde palīdzēs saglabāt dabas resursus un garantēs, ka šīs iekārtas tiks otrreizēji pārstrādātas tādā veidā, lai pasargātu vidi un cilvēku veselību. Lai uzzinātu, kur nolietotās iekārtas var izmest otrreizējai pārstrādei, jāvēršas savas dzīves vietas pašvaldībā, sadzīves atkritumu savākšanas dienestā vai veikalā, kurā izstrādājums tika nopirkts.

Verwijdering van afgedankte apparatuur door privé-gebruikers in de Europese Unie



Dit symbool op het product of de verpakking geeft aan dat dit product niet mag worden gedeponerd bij het normale huishoudelijke afval. U bent zelf verantwoordelijk voor het inleveren van uw afgedankte apparatuur bij een inzamelingspunt voor het recyclen van oude elektrische en elektronische apparatuur. Door uw oude apparatuur apart aan te bieden en te recyclen, kunnen natuurlijke bronnen worden behouden en kan het materiaal worden hergebruikt op een manier waarmee de volksgezondheid en het milieu worden beschermd. Neem contact op met uw gemeente, het afvalinzamelingsbedrijf of de winkel waar u het product hebt gekocht voor meer informatie over inzamelingspunten waar u oude apparatuur kunt aanbieden voor recycling.

Eliminering av utstyr i privathusholdningen i Den europeiske unions medlemsland



Dette symbolet på produktet eller emballasjen betyr at produktet ikke må kastes med vanlig husholdningsavfall. I stedet er du ansvarlig for at utbrukt utstyr leveres inn til et angitt innsamlingssted for resirkulering av elektrisk og elektronisk utstyr. Denne separate innsamlingen og resirkuleringen av utbrukt utstyr vil bidra til å bevare naturressursene - resirkuleringen foretas på en måte som beskytter menneskelig helse og miljø. For å få vite hvor du kan levere inn utbrukt utstyr for resirkulering, vennligst ta kontakt med det lokale kommunekontoret, renovasjonsvesenet eller forretningen der du kjøpte produktet.

Pozbywanie się zużytego sprzętu przez użytkowników w prywatnych gospodarstwach domowych w Unii Europejskiej



Ten symbol na produkcie lub jego opakowaniu oznacza, że produktu nie wolno wyrzucać do zwykłych pojemników na śmieci. Obowiązkiem użytkownika jest przekazanie zużytego sprzętu do wyznaczonego punktu zbiórki w celu recyklingu odpadów powstałych ze sprzętu elektrycznego i elektronicznego. Osobna zbiórka oraz recykling zużytego sprzętu pomogą w ochronie zasobów naturalnych i zapewnią ponowne wprowadzenie go do obiegu w sposób chroniący zdrowie człowieka i środowisko. Aby uzyskać więcej informacji o tym, gdzie można przekazać zużyty sprzęt do recyklingu, należy się skontaktować z urzędem miasta, zakładem gospodarki odpadami lub sklepem, w którym zakupiono produkt.

Destruição, por Utilizadores na União Europeia, de Equipamento Usado no Lixo Doméstico



Este símbolo, no produto ou na respectiva embalagem, indica que este material não deve ser destruído com outro lixo doméstico. É da sua responsabilidade destruir o equipamento usado levando-o para um local de recolha apropriado, destinado à reciclagem de produtos eléctricos e electrónicos usados. A recolha e reciclagem separada do seu equipamento doméstico quando da destruição, ajudará a preservar os recursos naturais e a assegurar que ele é reciclado através de um processo que protege a saúde humana e o ambiente. Para obter mais informações sobre onde pode colocar o seu equipamento usado para reciclagem, contacte a entidade responsável local, o serviço de destruição do lixo doméstico, ou a loja onde adquiriu o produto.

Утилизация оборудования владельцами частных домов в странах Европейского Союза



Этот символ на изделии или его упаковке означает, что изделие нельзя выбрасывать вместе с обычным бытовым мусором. Вы обязаны сдать ненужное оборудование в специальный пункт приема и утилизации электрооборудования. Отделение ненужного электрооборудования от прочего бытового мусора и его отдельная утилизация помогут сохранить природные ресурсы и обеспечить переработку отходов безопасным для здоровья человека и окружающей среды способом. За дополнительной информацией о том, куда можно сдать ненужное электрооборудование, обращайтесь в администрацию города, местную службу утилизации отходов или магазин, где было приобретено изделие.

Bortskaffande av avfallsprodukter från användare i privathushåll inom Europeiska Unionen



Om den här symbolen visas på produkten eller förpackningen betyder det att produkten inte får slängas på samma ställe som hushållssopor. I stället är det ditt ansvar att bortskaffa avfallet genom att överlämna det till ett uppsamlingsställe avsett för återvinning av avfall från elektriska och elektroniska produkter. Separat insamling och återvinning av avfallet hjälper till att spara på våra naturresurser och gör att avfallet återvinns på ett sätt som skyddar människors hälsa och miljön. Kontakta ditt lokala kommunkontor, din närmsta återvinningsstation för hushållsavfall eller affären där du köpte produkten för att få mer information om var du kan lämna ditt avfall för återvinning.

Odstranjevanje odslužene opreme uporabnikov v zasebnih gospodinjstvih v Evropski uniji



Ta znak na izdelku ali njegovi embalaži pomeni, da izdelka ne smete odvreči med gospodinjske odpadke. Nasprotno, odsluženo opremo morate predati na zbirališče, pooblaščno za recikliranje odslužene električne in elektronske opreme. Ločeno zbiranje in recikliranje odslužene opreme prispeva k ohranjanju naravnih virov in zagotavlja recikliranje te opreme na zdravju in okolju neškodljiv način. Za podrobnejše informacije o tem, kam lahko odpeljete odsluženo opremo na recikliranje, se obrnite na pristojni organ, komunalno službo ali trgovino, kjer ste izdelek kupili.

Likvidácia vyradených zariadení v domácnostiach v Európskej únii



Symbol na výrobku alebo jeho balení označuje, že daný výrobok sa nesmie likvidovať s domovým odpadom. Povinnosťou spotrebiteľa je odovzdať vyradené zariadenie v zbernom mieste, ktoré je určené na recykláciu vyradených elektrických a elektronických zariadení. Separovaný zber a recyklácia vyradených zariadení prispieva k ochrane prírodných zdrojov a zabezpečuje, že recyklácia sa vykonáva spôsobom chrániacim ľudské zdravie a životné prostredie. Informácie o zberných miestach na recykláciu vyradených zariadení vám poskytne miestne zastupiteľstvo, spoločnosť zabezpečujúca odvoz domového odpadu alebo obchod, v ktorom ste si výrobok zakúpili.

Eliminación de residuos de equipos eléctricos y electrónicos por parte de usuarios particulares en la Unión Europea



Este símbolo en el producto o en su envase indica que no debe eliminarse junto con los desperdicios generales de la casa. Es responsabilidad del usuario eliminar los residuos de este tipo depositándolos en un "punto limpio" para el reciclado de residuos eléctricos y electrónicos. La recogida y el reciclado selectivos de los residuos de aparatos eléctricos en el momento de su eliminación contribuirá a conservar los recursos naturales y a garantizar el reciclado de estos residuos de forma que se proteja el medio ambiente y la salud. Para obtener más información sobre los puntos de recogida de residuos eléctricos y electrónicos para reciclado, póngase en contacto con su ayuntamiento, con el servicio de eliminación de residuos domésticos o con el establecimiento en el que adquirió el producto.

Avrupa Birliđi'nde Hurda Donanımlar ın Özel Konutlardaki Kullanıcılar Tarafından Elden Çıkarılması



Tento Ürünün veya ambalajının üzerindeki bu simge, bu ürünün diđer ev atıklarıyla birlikte elden çıkarılmaması gerektiđini belirtir. Hurda donanımınızın elektrikli ve elektronik hurda donanımları geri dönüştürmek için belirlenmiş toplama merkezlerine teslim edilmesi, sizin sorumluluđunuzdadır. Elden çıkardığınız hurda donanımınızın ayrı olarak toplanması ve geri dönüştürülmesi, doğal kaynakların korunmasına yardımcı olacak ve insan sađlığına ve çevreye zararlı olmayan bir yöntemle geri dönüştürülmesini sađlayacaktır. Hurda donanımınızı teslim edebileceğiniz geri dönüştürme merkezleri hakkında ayrıntılı bilgi için lütfen bölgenizdeki belediye makamlarına, ev atıklarınızı toplayan kuruluşa veya ürünü satın aldıđınız mađazaya başvurun.

Equipment Warning

⚠ WARNING! To reduce the risk of personal injury, electrical shock, fire or damage to the equipment:

Plug the AC adapter into an AC outlet that is easily accessible at all times.

Disconnect power from the equipment by unplugging the AC adapter from the AC outlet or unplugging the synchronization cable from the host computer.

Do not place anything on the power cord or any of the other cables. Arrange them so that no one may accidentally step on or trip over them.

Do not pull on a cord or cable. When unplugging from the electrical outlet, grasp the cord by the plug or, in the case of the AC adapter, grasp the AC adapter and pull out from the electrical outlet.

Do not use converter kits sold for appliances to power your HP iPAQ.

Acoustics Warning

⚠ WARNING! Listening to this device at high volume levels and for extended durations may damage one's hearing. In order to reduce the risk of damage to hearing, one should lower the volume to a safe, comfortable level, and reduce the amount of time listening at high levels.



- For your own safety, before using headsets or earphones, always reset the volume. Some headphones are louder than other headphones, even if the volume control setting is the same.
- Changing the default audio or equalizer settings might lead to higher volume and should only be done with caution.
- Headsets or earphones used with this device should comply with the headphone limits in EN 50332-2.
- HP recommends using the headset delivered with your iPAQ (part number 455673-001) that is in compliance with EN 50332-1.

Class 1 LED Product

Airline Travel Notice

Use of electronic equipment aboard commercial aircraft is at the discretion of the airline.

Medical Electronic Equipment

If you have a medical condition that requires you to use a pacemaker, hearing aid, or any type of medical electronic equipment, consult the manufacturer of the equipment to determine if the medical equipment is shielded from RF energy. Turn off your HP iPAQ in health care facilities or hospitals when there are posted restrictions requiring you to do so.

SAR Notice

THIS DEVICE MEETS INTERNATIONAL GUIDELINES FOR EXPOSURE TO RADIO WAVES.

Your mobile device is a radio transmitter and receiver. It is designed and manufactured not to exceed the limits for exposure to radio frequency (RF) recommended by international guidelines (ICNIRP). These limits are part of comprehensive guidelines and establish permitted levels of RF energy for the general population. The guidelines were developed by independent scientific organizations through periodic and thorough evaluation of scientific studies. The guidelines include a substantial safety margin designed to assure the safety of all persons, regardless of age and health.

The exposure standard for mobile devices employs a unit of measurement known as the Specific Absorption Rate, or SAR. The SAR limit stated in the international guidelines is 2.0 W/kg*. Tests for SAR are conducted using standard operating positions with the device transmitting at its highest certified power level in all tested frequency bands. Although the SAR is determined at the highest certified power level, the actual SAR of the device while operating can be well below the maximum value. This is because the device is designed to operate at multiple power levels so as to use only the power required to reach the network.

In general, the closer you are to a base station, the lower the power output of the device. Before a phone model is available for sale to the public, compliance with the European R&TTE directive must be shown. This directive includes as one essential requirement the protection of the health and the safety for the user and any other person.

This device meets RF exposure guidelines when used either in the normal use position against the ear or when positioned away from the body. When a carry case, belt clip or holder is used for body-worn operation other than the HP belt clip supplied with the product, it should not contain metal.

The non-FCC SAR limit for mobile devices used by the public is 2.0 watts/kilogram (W/kg) averaged over ten grams of body tissue. The guidelines incorporate a substantial margin of safety to give additional protection for the public and to account for any variations in measurements. SAR values may vary depending on national reporting requirements and the network band.

Wireless Notices

In some environments, the use of wireless devices may be restricted. Such restrictions may apply aboard airplanes, in hospitals, near explosives, in hazardous locations, etc. If you are uncertain of the policy that applies to the use of this device, please ask for authorization to use it prior to turning it on.

U.S. Regulatory Wireless Notice

⚠ WARNING! Exposure to Radio Frequency (RF) Radiation The radiated output power of this device is below the FCC radio frequency exposure limits. Nevertheless, the device should be used in such a manner that the potential for human contact during normal operation is minimized.

To avoid the possibility of exceeding the FCC radio frequency exposure limits, human proximity to the antenna should be minimized. No metallic body accessories are allowed and 1.5 cm spacing between PDA and the body must be maintained to satisfy RF Exposure. The highest non-FCC SAR value for this device when tested for use at the ear is 1.25 W/kg (1g).

This PDA has been tested and demonstrated compliance when WLAN with Bluetooth and GSM with Bluetooth are transmitting simultaneously. The highest FCC SAR value for this device when tested for use at the head is 1.47 W/kg and when tested for use at the body is 1.52 W/kg. This PDA must not be co-located or operating in conjunction with any other antenna or transmitter.

Canadian Regulatory Wireless Notice

Operation is subject to the following two conditions: (1) this device may not cause interference, and (2) this device must accept any interference, including interference that may cause undesired operation of the device.

Brazilian Notice

Este equipamento opera em caráter secundário, isto é, não tem direito a proteção contra interferência prejudicial, mesmo de estações do mesmo tipo, e não pode causar interferência a sistemas operando em caráter primário.

Este equipamento atende aos limites de Taxa de Absorção Específica referente à exposição a campos elétricos, magnéticos e eletromagnéticos de radiofrequências adotados pela ANATEL.

Singaporean Wireless Notice

- Switch off your cellular telephone when in an aircraft. The use of cellular telephones in an aircraft may be dangerous to the operation of the aircraft, disrupt the cellular network, and is illegal. Failure to observe this instruction may lead to suspension or denial of cellular services to the offender, or legal action or both.
- Users are advised not to use the equipment when at a refueling point.
- Users are reminded of the need to observe restrictions on the use of radio equipment in fuel depots, chemical plants, or where blasting operations are in progress.
- The use of the Alert device to operate a vehicle's lights or horn on public roads is not permitted.
- It is advised that a handheld microphone or telephone handset should not be used by the driver while the vehicle is moving, except in an emergency. Speak only into a fixed, neck slung or clipped-on microphone when it would not distract your attention from the road.
- As with other mobile radio transmitting equipment, users are advised that for satisfactory operation of the equipment and for the safety of personnel, it is recommended that no part of the human body be allowed to come too close to the antenna during operation of the equipment.

Japanese Notice

この装置は、情報処理装置等電波障害自主規制協議会（VCCI）の基準に基づくクラスB情報技術装置です。この装置は、家庭環境で使用することを目的としていますが、この装置がラジオやテレビジョン受信機に近接して使用されると、受信障害を引き起こすことがあります。

取扱説明書に従って正しい取り扱いをして下さい。

この機器の使用用途等では、電子レンジ等の産業・科学・医療用機器のほか工場・製造ライン等で使用されている移動体通信用の屋内無線局（免許を要する無線局）及び特定小電力無線局（免許を要しない無線局）が運用されています。

- 1 この機器を使用する前に、近くで移動体通信用の屋内無線局及び特定小電力無線局が運用されていないことを確認して下さい。
- 2 万一、この機器から移動体通信用の屋内無線局に対して電波干渉の事例が発生した場合には、速やかに使用源消滅を要する場合は電波の放射を停止した上、下記連絡先にご連絡頂き、復旧のための処置等（例えば、パーティションの設置など）についてご相談して下さい。
- 3 その他、この機器から移動体通信用の特定小電力無線局に対して電波干渉の事例が発生した場合など何かお困りのことが起きたときは、次の連絡先へお問い合わせ下さい。

連絡先：日本ヒューレット・パカード株式会社 TEL.0120-014121

Wireless LAN 802.11b Devices



Wireless LAN 802.11g Devices



Bluetooth Devices



Taiwan DGT Notice

低功率電波輻射性電機管理辦法

第十四條 經型式認證合格之低功率射頻電機，非經許可，公司、商號或使用者均不得擅自變更頻率、加大功率或變更原設計之特性及功能。

第十七條 低功率射頻電機之使用不得影響飛航安全及干擾合法通信；經發現有干擾現象時，應立即停用，並改善至無干擾時方得繼續使用。前項合法通信，指依電信規定作業之無線電信。低功率射頻電機須忍受合法通信或工業、科學及醫療用電波輻射性電機設備之干擾。

註：

1. SAR 標準值 2.0W/Kg:
送測產品實測值為:0.791 W/Kg.
2. 減少電磁波影響，請妥適使用。

Korean Notice

B급 기기 (가정용 정보통신기기)

이 기기는 가정용으로 전자파적합등록을 한 기기로서
주거지역에서는 물론 모든지역에서 사용할 수 있습니다.

21 Frequently Asked Questions

I am having trouble turning on my HP iPAQ. What should I do?

Your HP iPAQ seems to have problems with the battery. Please perform the following checks:

- Is the battery charged? If the LED on your HP iPAQ is flashing red, it indicates a low battery charge. For best results, charge the battery fully. The solid green LED display indicates full battery charge.
- Is the battery properly installed? Make sure the battery connectors on the battery are aligned with the housing pins in the battery compartment. For more information, see [Step 2: Install the battery and replace the battery cover on page 8](#).
- Are the battery connectors on the battery and housing pins in the battery compartment clean? If these appear to be soiled, contact your dealer to get them cleaned.
- Try charging your battery using the AC adapter. For more information, see [Step 3: Charge the battery on page 9](#).
- Perform a hard reset on your HP iPAQ by pressing and holding the **Power** button and simultaneously pressing and holding the **Reset** button. Make sure that you press and hold the **Power** button before you press and hold the **Reset** button, and then turn on your HP iPAQ.

I am unable to make or receive calls. How do I fix this?

If you have problems making or receiving calls, please perform the following checks:

- Is the reception of the network signal good? You might be located within closed boundaries. If yes, move to an open space or closer to a window. For more information, see [Check connection and signal strength on page 25](#).
- Is the network set up properly? If necessary, try to select your network manually. For more information, see [View available phone networks on page 28](#).
- Have you activated the **Fixed Dialing**, **Call Forwarding**, and **Call Barring** functions? If yes, deactivate them temporarily.
- Are you using two SIM cards, one with the **Enable SIM PIN** function activated and the other with the **Enable SIM PIN** function deactivated? If yes, deactivate the **Enable SIM PIN** function temporarily. For more information, see [Change the SIM PIN on page 26](#).
- Is your HP iPAQ switched to the Flight mode? If yes, turn it off. For more information, refer [Use Wireless Manager on page 69](#).

I have trouble connecting to the Internet. What should I do?

If you have trouble connecting to the Internet, please perform the following checks:

- Is the reception of the network signal good? You might be located within closed boundaries. If yes, move to an open space or closer to a window. For more information, see [Check connection and signal strength on page 25](#).
- Make sure you have subscribed for a data service from your service operator.
- Make sure you entered correct setting parameters, such as APN and IP addresses in data profile setup.

I am unable to hear voices clearly. How do I resolve this?

Is the reception of the network signal good? You might be located within closed boundaries. If yes, move to an open space or closer to a window. For more information, see [Check connection and signal strength on page 25](#).

If you are unable to hear to voices clearly, make sure you have turned off the in-call mute function.

When I answer calls on my iPAQ, the caller is unable to hear my voice clearly. What could be the problem?

During a call, if the caller is unable to hear to voices clearly, make sure you have turned off the in-call mute function.

I cannot use certain call functions. What should I do?

To use certain advanced call functions, such as **Call Forwarding** and **Call Barring**, you may need to subscribe to these services from your service operator.

Why do I hear noises in the background during a phone call?

You may hear noises in the background if you use your HP iPAQ near electronic equipments, such as microwave oven, speakers, or a television set. Avoid using your HP iPAQ near such items as it has an adverse effect on the voice quality.

How can I improve the standby time and talk time on my HP iPAQ?

Follow the guidelines given below to improve the standby and talk times on your HP iPAQ.

- The HP iPAQ may consume more power when the signal reception is poor. Try to move to an open location when you use your HP iPAQ.
- If you are using a new battery, it may take several charging and discharging cycles to reach its original capacity. Use the HP iPAQ after charging the battery completely. The solid green LED display indicates full battery charge.

- If your battery is very old, replace it with a new one.
- Avoid using the HP iPAQ in very high or low temperature environments. The efficiency of a battery can be affected by extreme temperature conditions. To know more about the operating temperatures on your HP iPAQ, see [Operating environment on page 103](#).

Why does the HP iPAQ operate slowly sometimes?

You should have at least 1.5 to 2 MB of free memory space on your HP iPAQ so that the device operates efficiently. To check the free memory space, tap **Start > Settings > System > Memory**.

Remember to delete or transfer old e-mail messages and pictures on your HP iPAQ to free available memory space. If you have many applications running on your HP iPAQ, close some applications to free memory. For more information, see [Open and close programs on page 16](#) and [Install and remove programs on page 16](#).

I have trouble charging my battery. What should I do?

If you have trouble charging your battery, please perform the following checks:

- Is the battery charger correctly plugged into the battery charger socket on the HP iPAQ? To know more about charging the battery, see [Step 3: Charge the battery on page 9](#)
- Is the power cord of the charger damaged?
- Is the battery very old? If yes, replace with a new battery and try again.

I am unable to synchronize my HP iPAQ with my computer. What should I do?

To use the ActiveSync feature with Windows XP, upgrade your computer to the latest version of ActiveSync. It is recommended to use ActiveSync 4.5 or a higher version.

To use the WMDC feature with Windows Vista, upgrade your computer to the latest version of WMDC. It is recommended to use WMDC 6.1 or a higher version.

Visit <http://www.microsoft.com/downloads> for the latest versions.

Which factors degrade the GPS signal and affect accuracy?

The GPS signal slows down when:

- It reflects off objects such as tall buildings or large rock surfaces before reaching the receiver. Performance is impacted when the device is used inside vehicles having thermal glass windshields. The thermally shielded glass blocks the GPS signal from reaching the device.
- You are indoor, underwater, or underground.
- You are running multiple applications while connecting.

My HP iPAQ was connected while I was installing WMDC. But, WMDC does not launch even after installation?

In some cases after an upgrade, you will need to disconnect and reconnect the device for WMDC to launch.

Can I set up an active connection between my HP iPAQ and a computer using Bluetooth for the first time?

No, the initial connection between your HP iPAQ and the computer needs to be created only through a mini-USB synchronization cable using ActiveSync for Windows XP and WMDC for Windows Vista. After this initial connection, you will be able to set up Bluetooth for future connections.

22 Safety information

To reduce the risk of bodily injury, electric shock, fire, and damage to the equipment, observe the safety precautions in this document.

General Precautions

Heed service markings: Except as explained elsewhere in your product documentation, do not service your product yourself. Opening or removing covers that are marked  may expose you to electric shock. For service information on components inside these compartments, call Customer Care.

Request service for damaged products: Turn off the product, unplug it from the electrical outlet, and request service from a service partner under the following conditions:

- The power cord or plug is damaged.
- Liquid has been spilled into the product.
- An object has fallen into the product.
- The product has been exposed to rain or water.
- The product has been dropped or damaged.
- There are noticeable signs of overheating.
- The product does not operate normally when you follow the operating instructions.

Avoid hot areas: The product should be placed away from heat sources such as radiators, heat registers, stoves, and other products (such as amplifiers) that produce heat.

Allow the product to cool: Allow the product to cool before removing covers and touching internal components.

Avoid wet areas: Never use the product in a wet location.

Avoid inserting objects into product: Never insert objects of any kind into slots or other openings in the product.

Avoid blocking vents: Slots and openings are provided for ventilation. To prevent overheating, do not obstruct vents. Using a computer on a soft surface, such as a pillow, blanket, rug, or thick clothing may block airflow.

Clean the product properly: Unplug the product from the wall outlet before cleaning it. Do not use liquid cleaners or aerosol cleaners. Use a soft cloth dampened with water for cleaning exterior components, but NEVER apply water directly to the product or to an LCD screen.

Use recommended mounting accessories: Do not use the product on an unstable table, cart, stand, tripod, or bracket. Mount the product according to the manufacturer's instructions, and use a mounting accessory recommended by the manufacturer.

Use the product with approved equipment: Use your product only with the computers and accessories identified as suitable for use with your product.

Adjust the volume: Turn down the volume before using headphones or other audio devices.

Safety Precautions for Power Cords and Accessories

⚠ WARNING! To reduce the risk of electric shock, fire, or damage to the equipment, do not attempt to power the product with a voltage converter kit sold for appliances.

Use the correct external power source: A product should be operated only from the type of power source indicated on the electrical ratings label. If you are not sure of the type of power source required, call Customer Care, your service partner, or local power company. For a product that operates from battery power or other sources, refer to the operating instructions that are included with the product.

Avoid overloading the electrical circuit: Do not overload an electrical outlet, power strip, or convenience receptacle. The overall system load must not exceed 80% of the branch circuit rating. If power strips are used, the load should not exceed 80% of the input rating of the power strip.

Observe extension cord ratings: If an extension cord or power strip is used, make sure that the cord or strip is rated for the product and that the total ampere ratings of all products plugged into the extension cord or power strip do not exceed 80% of the ampere rating limit of the extension cord or power strip.

Select the correct voltage: Ensure that the voltage select switch on the product is in the correct position for the type of voltage you use (115 V ac or 230 V ac).

Use an approved AC adapter: Only the AC adapter provided with the product, a replacement AC adapter provided by HP, or an AC adapter purchased as an accessory from HP should be used with the product.

Use an approved power cord: If you were not provided with a power cord for your product, you should purchase a power cord that is approved for use in your country.

The power cord must be rated for the product and for the voltage and current marked on the electrical ratings label of the product. The voltage and current rating of the cord should be greater than the voltage and current rating marked on the product. In addition, the diameter of the wire must be a minimum of 0.75 mm²/18AWG, and the length of the cord should be between 1.5 meters (5 feet) and 2 meters (6.5 feet) long. If you have questions about the type of power cord to use, call Customer Care.

Position the power cord carefully: Route the power cord so that it will not be walked on, tripped over, or pinched by items placed upon or against it. Pay particular attention to the plug, electrical outlet, and the point where the power cord exits the product.

Plug power cord into the proper outlet: Plug the product into an electrical outlet that is easily accessible at all times. If the product is a 3-wire grounding type, be sure the outlet is the proper grounded (earthed) type. Do not disable the power cord grounding plug because it is an important safety feature.

Unplug the power cord properly: Disconnect power from the product by unplugging the power cord from the electrical outlet. Do not pull on cords and cables. When unplugging the cord from an electrical outlet, grasp and pull the cord by the plug.

Safety Precautions for Battery Packs

⚠ WARNING! To reduce the risk of fire or burns, do not disassemble, crush, or puncture a battery pack; short the external contacts on a battery pack; or dispose of a battery pack in fire or water. Do not expose a battery pack to high temperatures above 60°C (140°F). Replace only with a battery pack approved for this computer.

WARNING! There is a danger of explosion if a battery pack is incorrectly replaced. Replace it only with an approved battery pack for this product.

WARNING! Keep battery packs away from children.

Handle battery packs carefully: Replace a battery pack only with a battery pack approved for this product. For information about removing a battery pack, refer to your product documentation.



When a battery pack has reached the end of its useful life, do not dispose of the battery pack in general household waste. Follow the local laws and regulations in your area for computer battery pack disposal.

In Europe, dispose of or recycle the battery packs by using the public collection system or by returning them to HP, your service partner, or their agents.

Safety Precautions for Docking Devices

Avoid unstable mounting: Do not place a monitor with an unstable base or a monitor heavier than 25 kilograms (55 pounds) on top of a monitor stand, unless the monitor stand is marked for use with a heavier monitor. Instead, place the monitor on a work surface next to the docking device.

Safety Precautions for Products with Wireless Devices

-
- ⚠ **WARNING!** **Exposure to radio frequency radiation.** The radiated output power of wireless devices is below the FCC radio frequency exposure limits. Nevertheless, the device should be used in such a manner that the potential for human contact during normal operation is minimized. To avoid the possibility of exceeding the FCC radio frequency exposure limits, human proximity to the antenna should not be less than 20 cm (8 inches) during normal operation.
-

Safety Precautions for Products with Modems, Telecommunications or Local Area Network Accessories

-
- ⚠ **WARNING!** To reduce the risk of fire, electric shock, and injury to persons when using this device, always follow basic safety precautions, including the following:
-
- Do not use this product near water—for example: near a bathtub, washbowl, kitchen sink or laundry tub; in a wet basement; or near a swimming pool.
 - Avoid using this product during an electrical storm. There is a remote risk of electric shock from lightning.
 - Do not use this product to report a gas leak while in the vicinity of the leak.
 - Always disconnect the modem cable before opening the equipment enclosure or touching an uninsulated modem cable, jack, or internal component.
 - If this product was not provided with a telephone line cord, use only No. 26 AWG or larger telecommunication line cord in order to reduce the risk of fire.
 - Do not plug a modem or telephone cable into the RJ-45 (network) jack.

Safety Precautions for Products with Laser Devices

-
- ⚠ **WARNING!** In addition to the general precautions described earlier in this section, be sure to observe the following precautions when operating a product equipped with a laser device. Failure to observe these precautions could result in fire, bodily injury, and damage to the equipment.
-

For information about laser equipment repair, call Customer Care.

If your product is equipped with laser products, it complies with appropriate safety standards, including IEC 60825. With specific regard to the laser, the equipment complies with laser product performance standards set by government agencies for Class 1 laser products. It does not emit hazardous light; the beam is totally enclosed during all modes of customer operation and maintenance.

CDRH Regulations

The Center for Devices and Radiological Health (CDRH) of the U.S. Food and Drug Administration implemented regulations for laser products effective August 2, 1976. These regulations apply to laser products manufactured from August 1, 1976, onward. Compliance is mandatory for products marketed in the United States.

⚠ WARNING! Use of controls or adjustments, or performance of procedures other than those specified herein or in the laser product installation guide, may result in hazardous radiation exposure.



This system is classified as a Class 1 laser product. This label appears on the laser product.

23 Guidelines for care and maintenance

It is recommended that you follow certain guidelines to keep your HP iPAQ in a good condition and prevent it from possible damage.

Use your HP iPAQ

- Avoid using your HP iPAQ in dusty and extremely high or low temperature environments.
- Do not spill water on your HP iPAQ or use it in the rain.
- Avoid removing the battery without turning off your HP iPAQ in advance.
- Do not apply strong force or shock to your HP iPAQ.
- Keep the HP iPAQ and its accessories away from children.
- Do not insert metal objects into the charging/communications port of your HP iPAQ. This can short-circuit the battery and result in danger.

Cleaning your HP iPAQ

- Use a soft, clean, and slightly moistened cloth to clean your HP iPAQ. Do not let water come into contact with your HP iPAQ.
- Do not wipe your HP iPAQ with any corrosive liquid or coarse objects. This can damage the outer surface of your HP iPAQ.

Carrying or storing your HP iPAQ

- Do not leave your HP iPAQ in extreme high or low temperature environments.
- Remove the battery from your HP iPAQ if it is not going to be used for a long period of time. Store the HP iPAQ and its battery in a cool, dark, and dry place.

Use accessories

- Use original HP batteries and chargers to charge your HP iPAQ.
- Do not use your HP iPAQ battery and charger for other purposes.
- For information on accessories for your iPAQ, visit <http://www.hp.com/go/ipaqattach>.