

# CASIO®

Digital Camera

# EX-H20G

## User's Guide

E

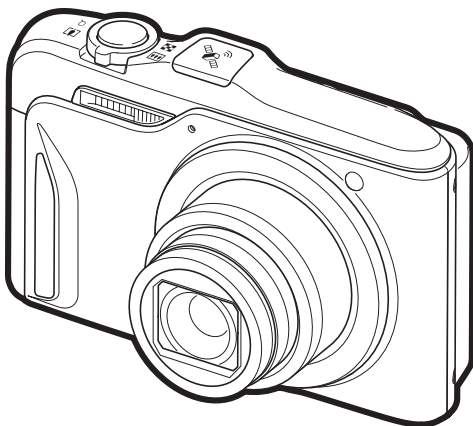

Thank you for purchasing this CASIO product.

- Before using it, be sure to read the precautions contained in this User's Guide.
- Keep the User's Guide in a safe place for future reference.
- For the most up-to-date information about this product, visit the official EXILIM Website at <http://www.exilim.com/>

To go to “Getting the Most Out of Dynamic Photo” click here!

Dynamic Photo

# EXILIM

## Unpacking

As you unpack your camera, check to make sure that all items shown below are included. If anything is missing, contact your original retailer.



Digital camera



Rechargeable lithium ion battery (NP-90)

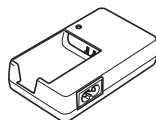

Charger unit (BC-90L)



\* The shape of the power cord plug varies according to country or geographic area.

Power cord



To attach the strap to the camera

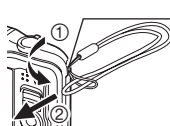

Attach strap here.

Strap



USB cable

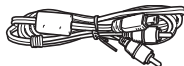

AV cable



CD-ROM



Quick Start Guide

## Read this first!

- The contents of this manual and the bundled Quick Start Guide are subject to change without notice.
- The contents of this manual have been checked at each step of the production process. Feel free to contact us if you notice anything that is questionable, erroneous, etc.
- Any copying of the contents of this User's Guide, either in part or its entirety, is forbidden. Except for your own personal use, any other use of the contents of this manual without the permission of CASIO COMPUTER CO., LTD. is forbidden under copyright laws.
- The map data, photogenic spot data, and place name data that comes in camera memory is intended for your own personal use only. Use for any other purpose without the permission of the original copyright owner(s) is prohibited.
- The map data, recommended photogenic spot data, and place name data displayed by the camera may not match actual place names and proper names.
- CASIO COMPUTER CO., LTD. shall not be held liable for any damages or lost profits suffered by you or any third party due to the use or malfunction of this product.
- The Hybrid-GPS function of this camera was designed and manufactured for personal digital camera use only. Never try to use it as a navigation instrument for an aircraft, motor vehicle, personal navigation, or any other type of navigation, or for surveying. CASIO shall not be held liable in any way for any damages incurred due to attempts to use the positioning information produced by this camera for any of the purposes mentioned above.
- CASIO COMPUTER CO., LTD. shall not be held liable for any damages, lost profits, or claims by third parties arising out of the use of Photo Transport or YouTube Uploader for CASIO.
- CASIO COMPUTER CO., LTD. shall not be held liable for any damages or lost profits caused by loss of memory contents due to malfunction, repair, or any other reason.
- Note that the example screens and product illustrations shown in this User's Guide may differ somewhat from the screens and configuration of the actual camera.

### LCD Panel

The liquid crystal panel of the monitor screen uses high-precision technology that provides a pixel yield in excess of 99.99%. This means that some very small number of pixels may not light or may remain lit at all times. This is due to the characteristics of the liquid crystal panel, and does not indicate malfunction.

#### Take a few test shots

Before shooting your final image, shoot a test shot to ensure that the camera is recording correctly.

# Contents

Unpacking .....	2
Read this first! .....	3
General Guide .....	10
Monitor Screen Contents .....	11

## ■ Quick Start Basics 14

---

What is a digital camera? .....	14
What you can do with your CASIO camera .....	15
First, charge the battery prior to use .....	17
■ To charge the battery .....	17
■ To load the battery .....	18
Configuring Basic Settings the First Time You Turn On the Camera .....	20
Preparing a Memory Card .....	22
■ Supported Memory Cards .....	22
■ To load a memory card .....	22
■ To format (initialize) a new memory card .....	23
Turning the Camera On and Off .....	24
■ To turn power on .....	24
■ To turn off the camera .....	24
Holding the Camera Correctly .....	25
To shoot a snapshot .....	26
■ Selecting an Auto Recording Mode .....	26
■ To shoot a snapshot .....	27
Viewing Snapshots .....	30
Deleting Snapshots and Movies .....	31
■ To delete a single file .....	31
■ To delete specific files .....	31
■ To delete all files .....	32
Snapshot Shooting Precautions .....	32
■ Auto Focus Restrictions .....	33

## ■ Snapshot Tutorial 34

---

Using the Control Panel .....	34
Changing the Image Size .....	(Size) 35
Using Flash .....	(Flash) 37
Selecting a Focus Mode .....	(Focus) 39
Specifying the Auto Focus Area .....	(AF Area) 41
Specifying ISO Sensitivity .....	(ISO) 43
Using the Self-timer .....	(Self-timer) 44
Using Face Detection .....	(Face Detection) 45
Correcting Image Brightness .....	(EV Shift) 46
Changing the Control Panel Date/Time Style .....	47
Shooting with Zoom .....	47
■ Interpreting the Zoom Bar .....	48

■ Zooming with Super Resolution . . . . . (Single SR Zoom) . . . . .	49
--	----

---

## ■ Recording Movie Images 50

---

To record a movie . . . . .	50
-----------------------------	----

---

## ■ Using BEST SHOT 52

---

What is BEST SHOT? . . . . .	52
■ Some Sample Scenes . . . . .	52
To shoot an image with BEST SHOT . . . . .	52
■ Creating Your Own BEST SHOT Setups . . . . .	54
Shooting a Panorama Image . . . . . (Slide Panorama) . . . . .	55
Recording a Self-portrait . . . . .	57

---

## ■ Advanced Settings 58

---

Using On-screen Menus . . . . .	58
REC Mode Settings . . . . . (REC) . . . . .	60
■ Selecting a Focus Mode . . . . . (Focus) . . . . .	60
■ Using the Self-timer . . . . . (Self-timer) . . . . .	60
■ Shooting with Face Detection . . . . . (Face Detection) . . . . .	60
■ Shooting with Continuous Auto Focus . . . . . (Continuous AF) . . . . .	60
■ Reducing the Effects of Camera and Subject Movement . . . . . (Anti Shake) . . . . .	61
■ Specifying the Auto Focus Area . . . . . (AF Area) . . . . .	61
■ Using the Auto Focus Assist Light . . . . . (AF Assist Light) . . . . .	62
■ Changing the Focus Frame Shape . . . . . (Focus Frame) . . . . .	62
■ Turning Digital Zoom On or Off . . . . . (Digital Zoom) . . . . .	63
■ Displaying the On-screen Grid . . . . . (Grid) . . . . .	63
■ Turning on Image Review . . . . . (Review) . . . . .	63
■ Using Icon Help . . . . . (Icon Help) . . . . .	63
■ Configuring Power On Default Settings . . . . . (Memory) . . . . .	64
Image Quality Settings . . . . . (Quality) . . . . .	65
■ Shooting Snapshots of better Texture and Sharpness . . . . . (Single SR Quality) . . . . .	65
■ Zooming with Super Resolution . . . . . (Single SR Zoom) . . . . .	65
■ Specifying Snapshot Size . . . . . (Size) . . . . .	65
■ Specifying Snapshot Image Quality . . . . . (Quality (Snapshot)) . . . . .	66
■ Specifying Movie Image Quality . . . . . (Quality (Movie)) . . . . .	66
■ Recording Beautiful Images of People and Scenery . . . . . (Effect) . . . . .	67
■ Correcting Image Brightness . . . . . (EV Shift) . . . . .	68
■ Controlling White Balance . . . . . (White Balance) . . . . .	69
■ Specifying ISO Sensitivity . . . . . (ISO) . . . . .	70
■ Specifying the Metering Mode . . . . . (Metering) . . . . .	70
■ Optimizing Image Brightness . . . . . (Lighting) . . . . .	71
■ Using Built-in Color Filters . . . . . (Color Filter) . . . . .	71
■ Controlling Image Sharpness . . . . . (Sharpness) . . . . .	71
■ Controlling Color Saturation . . . . . (Saturation) . . . . .	71
■ Adjusting Image Contrast . . . . . (Contrast) . . . . .	72
■ Specifying Flash Intensity . . . . . (Flash Intensity) . . . . .	72

## ■ Viewing Snapshots and Movies

73

Viewing Snapshots .....	73
Viewing a Movie .....	73
Viewing a Panorama Image .....	74
Zooming an On-screen Image .....	75
Displaying the Image Menu .....	75
Displaying Images in the Calendar Screen .....	76
Viewing Snapshots and Movies on a TV Screen .....	76
■ Viewing High-quality Movies on a Hi-Vision Television .....	78

## ■ Other Playback Functions

(PLAY) 80

Playing a Slideshow on the Camera .....	(Slideshow) .. 80
■ Saving Music from Your Computer to Camera Memory .....	82
Creating a Snapshot of Movie Frames .....	(MOTION PRINT) .. 83
Editing a Movie on the Camera .....	(Movie Editing) .. 83
Optimizing Image Brightness .....	(Lighting) .. 85
Adjusting White Balance .....	(White Balance) .. 85
Adjusting the Brightness of an Existing Snapshot .....	(Brightness) .. 86
Selecting Images for Printing .....	(DPOF Printing) .. 86
Protecting a File Against Deletion .....	(Protect) .. 87
Editing the Date and Time of an Image .....	(Date/Time) .. 88
Deleting Location Information from an Image .....	(Delete Site Info) .. 88
Rotating an Image .....	(Rotation) .. 89
Resizing a Snapshot .....	(Resize) .. 89
Cropping a Snapshot .....	(Trimming) .. 90
Copying Files .....	(Copy) .. 90

## ■ Using the Hybrid-GPS

91

Recording Current Location Information (Latitude, Longitude, Direction, Place Name) with Image Data .....	92
■ Enabling the GPS Function .....	(GPS) .. 92
■ Recording Location Information with Image Data .....	(Record Lat/Long) .. 93
■ Inserting the Place Name into Image Data .....	(Insert Place) .. 94
■ Stamping the Place Name into an Image .....	(Stamp Place) .. 96
■ Precautions when Using the Hybrid-GPS .....	97
Using the Map Data Stored in Camera Memory .....	(MAP Mode) .. 99
■ About the MAP mode .....	99
■ MAP Mode Monitor Screen Content .....	100
■ MAP Mode Operation .....	102
■ Basic MAP Mode Settings .....	104
Using Other Map Data .....	(MAP Tab Menu) .. 105
■ Saving Position Information .....	(Save Log) .. 105
■ Tracking Your Movements on a Map .....	(Show Log) .. 105
■ Specifying the Display Period of Tracks .....	(Log Period) .. 106

■ Enabling Movement of the Image Cursor . . . . . (Move Cursor) . . . . .	106
■ Adjusting the Accuracy of the Direction Sensor . . . . . (Direction Adj) . . . . .	106
■ Converting Location Information of Images from Another Source for Playback on This Camera . . . . . (Update Info) . . . . .	107
Other Settings . . . . . (Set Up Tab Menu) . . . . .	108
■ Auto Image Orientation Detection and Rotation . . . . . (Auto Rotate) . . . . .	108
■ Correcting Camera Clock Settings Automatically . . . . . (Time Auto Correct) . . . . .	108
Displaying Images with Location Information . . . . . (PLAY Mode) . . . . .	109
■ Viewing an Image with Location Information . . . . .	109
■ Clearing Location Information Included with an Image . . . . . (Delete Site Info) . . . . .	109
Precautions when Using the Hybrid-GPS . . . . .	110

---

## ■ Dynamic Photo 111

Inserting a Built-in Subject into a Snapshot or Movie . . . . . (Dynamic Photo) . . . . .	111
■ To view a Dynamic Photo . . . . . (Dynamic Photo File) . . . . .	113
Converting a Dynamic Photo Still Image to a Movie . . . . . (Movie Converter) . . . . .	113

---

## ■ Printing 114

Printing Snapshots . . . . .	114
Connecting Directly to a PictBridge Compatible Printer . . . . .	115
Using DPOF to Specify Images to be Printed and the Number of Copies . . . . .	117

---

## ■ Using the Camera with a Computer 120

Things you can do using a computer . . . . .	120
Using the Camera with a Windows Computer . . . . .	121
■ Viewing and Storing Images on a Computer . . . . .	122
■ Playing Movies . . . . .	125
■ Uploading Movie Files to YouTube . . . . .	126
■ Transferring Images from Your Computer to Camera Memory . . . . .	128
■ Viewing an Image's Recording Location . . . . .	130
■ Viewing User Documentation . . . . . (PDF Files) . . . . .	130
■ User Registration . . . . .	130
Using the Camera with a Macintosh . . . . .	131
■ Connecting the Camera to Your Computer and Saving Files . . . . .	131
■ Transferring Images Automatically and Managing Them on Your Macintosh . . . . .	134
■ Playing a Movie . . . . .	134
■ Viewing User Documentation . . . . . (PDF Files) . . . . .	135
■ User Registration . . . . .	135
Using an Eye-Fi Wireless SD Memory Card to Transfer Images . . . . . (Eye-Fi) . . . . .	135
Files and Folders . . . . .	137
Memory Card Data . . . . .	138

Adjusting Monitor Screen Brightness . . . . . (Screen)	140
Turning off Eye-Fi Card Communication . . . . . (Eye-Fi)	140
Enabling the GPS Function . . . . . (GPS)	141
Recording Location Information with Image Data . . . . . (Record Lat/Long)	141
Auto Image Orientation Detection and Rotation . . . . . (Auto Rotate)	141
Configuring Camera Sound Settings . . . . . (Sounds)	142
Configuring a Startup Image . . . . . (Startup)	142
Specifying the File Name Serial Number Generation Rule . . . . . (File No.)	143
Creating an Image Storage Folder . . . . . (Create Folder)	143
Configuring World Time Settings . . . . . (World Time)	144
Time Stamping Snapshots . . . . . (Timestamp)	145
Stamping a Place Name into an Image . . . . . (Stamp Place)	145
Adjusting the Camera Clock Setting Automatically . . . . . (Time Auto Correct)	145
Setting the Camera's Clock . . . . . (Adjust)	146
Specifying the Date Style . . . . . (Date Style)	146
Specifying the Display Language . . . . . (Language)	147
Configuring Sleep State Settings . . . . . (Sleep)	147
Configuring Auto Power Settings . . . . . (Auto Power Off)	148
Configuring [📷], [▶], and [🌐] Settings . . . . . (REC/PLAY)	148
Disabling File Deletion . . . . . (🗑 Disabled)	149
Configuring USB Protocol Settings . . . . . (USB)	149
Selecting the Screen Aspect Ratio and Video Output System (Video Out)	150
Selecting the HDMI Terminal Output Method . . . . . (HDMI Output)	150
Formatting Built-in Memory or a Memory Card . . . . . (Format)	151
Resetting the Camera to Factory Defaults . . . . . (Reset)	151

**Configuring Monitor Screen Settings**

Using the On-screen Histogram to Check Exposure . . . . .	152
■ How to Use the Histogram . . . . .	153



Precautions during Use . . . . .	154
Power Supply . . . . .	161
■ Charging . . . . .	161
■ To replace the battery . . . . .	161
■ Battery Precautions. . . . .	162
■ Using the Camera in another Country . . . . .	162
Using a Memory Card . . . . .	163
■ To replace the memory card . . . . .	163
Computer System Requirements for Bundled Software . . . . . (Bundled CD-ROM) . . . . .	165
Reset Initial Default Settings . . . . .	167
When things don't go right... . . . .	170
■ Troubleshooting . . . . .	170
■ Display Messages. . . . .	176
Number of Snapshots/Movie Recording Time . . . . .	179
Specifications . . . . .	181

## General Guide

The numbers in parentheses indicate the pages where each item is explained.

### ■ Camera

#### Front

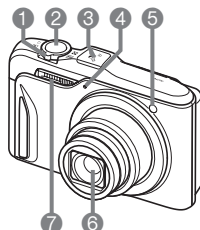

- 1 Zoom controller (pages 26, 47, 75, 76)
- 2 Shutter button (page 27)
- 3 GPS antenna (page 97)
- 4 Microphone (pages 25, 51)
- 5 Front lamp (pages 44, 62)
- 6 Lens
- 7 Flash (page 37)
- 8 [↓] (Current Location) button (page 102)
- 9 [Globe] (MAP) button (pages 24, 99)

#### Back

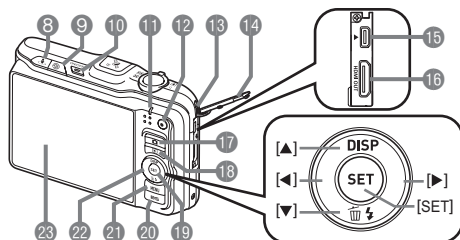

- 10 [ON/OFF] (Power) (page 24)
- 11 Back lamp (pages 24, 27, 37)
- 12 [●] (Movie) button (page 50)
- 13 Strap hole (page 2)
- 14 Connector cover
- 15 [USB/AV] port (pages 76, 115, 123, 132)
- 16 [HDMI OUT] HDMI output (Mini) (page 78)
- 17 [REC] button (pages 24, 26)
- 18 [▶] (PLAY) button (pages 24, 30)
- 19 [SET] button (page 34)
- 20 [BS] button (page 52)
- 21 [MENU] button (page 58)
- 22 Control button ([▲] [▼] [◀] [▶]) (pages 31, 34, 37, 58, 152)
- 23 Monitor screen (pages 11, 152)

#### Bottom

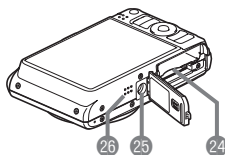

- 24 Battery/memory card slots (pages 18, 22, 161, 163)
- 25 Tripod hole  
Use this hole when attaching to a tripod.
- 26 Speaker

## ■ Charger Unit

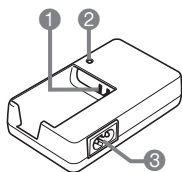

- ① + ⊕ ⊖ Contacts
- ② [CHARGE] Lamp
- ③ AC jack

## Monitor Screen Contents

The monitor screen uses various indicators, icons, and values to keep you informed of the camera's status.

- The sample screens in this section are intended to show you the locations of all the indicators and figures that can appear on the monitor screen in various modes. They do not represent screens that actually appear on the camera.

## ■ Snapshot Recording

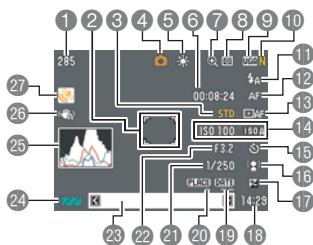

- ① Remaining snapshot memory capacity (page 179)
- ② Focus frame (pages 27, 41)
- ③ Movie image quality (page 66)
- ④ Recording mode (page 26)
- ⑤ White balance setting (page 69)
- ⑥ Remaining movie memory capacity (page 50)
- ⑦ Zoom/Single SR Quality indicator (page 48)

- ⑧ Metering mode (page 70)
- ⑨ Snapshot image size (page 35)
- ⑩ Snapshot image quality (page 66)
- ⑪ Flash (page 37)
- ⑫ Focus (page 39)
- ⑬ AF Area (page 41)
- ⑭ ISO sensitivity (page 43)
- ⑮ Self-timer (page 44)
- ⑯ Face Detection/Make-up/Landscape (pages 45, 67, 68)
- ⑰ Exposure compensation (page 46)
- ⑱ Date/time (page 47)
- ⑲ Timestamp indicator (page 145)
- ⑳ Place name stamp (page 96)
- ㉑ Shutter speed
- ㉒ Aperture value
- ㉓ Place name of current location (page 94)
- ㉔ Battery level indicator (page 19)
- ㉕ Histogram (page 152)
- ㉖ Anti Shake (page 61)
- ㉗ GPS wave condition icon (pages 93, 103)

### NOTE

- If the current aperture, shutter speed, ISO sensitivity, or Auto Exposure is not correct, the setting will turn orange when you half-press the shutter button.

## Movie Recording

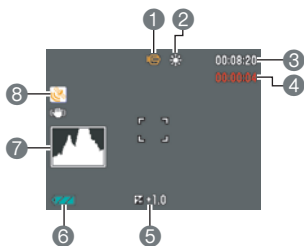

- 1 Recording mode (page 50)
- 2 White balance setting (page 69)
- 3 Remaining movie memory capacity (page 50)
- 4 Movie recording time (page 50)
- 5 Exposure compensation (page 46)
- 6 Battery level indicator (page 19)
- 7 Histogram (page 152)
- 8 GPS wave condition icon (pages 93, 103)

## Snapshot Viewing

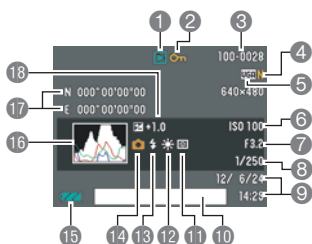

- 1 File type
- 2 Protect indicator (page 87)
- 3 Folder name/file name (page 137)
- 4 Snapshot image quality (page 66)
- 5 Snapshot image size (page 35)
- 6 ISO sensitivity (page 43)
- 7 Aperture value
- 8 Shutter speed
- 9 Date/time (page 47)
- 10 Shooting location name (page 94)
- 11 Metering mode (page 70)
- 12 White balance setting (page 85)
- 13 Flash (page 37)
- 14 Recording mode
- 15 Battery level indicator (page 19)
- 16 Histogram (page 152)
- 17 Latitude, longitude (page 93)
- 18 Exposure compensation (page 46)

## ■ Movie Playback

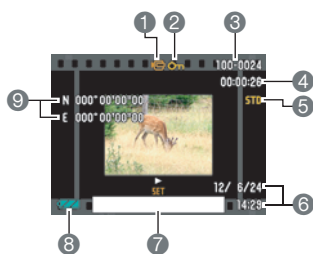

- 1 File type
- 2 Protect indicator (page 87)
- 3 Folder name/file name (page 137)
- 4 Movie recording time (page 73)
- 5 Movie image quality (page 66)
- 6 Date/time (page 47)
- 7 Shooting location name (page 94)
- 8 Battery level indicator (page 19)
- 9 Latitude, longitude (page 93)

### NOTE

- For details about MAP mode display contents, see “Using the Hybrid-GPS” (page 91).

# Quick Start Basics

## What is a digital camera?

A digital camera stores images on a memory card, so you can record and delete images a countless number of times.

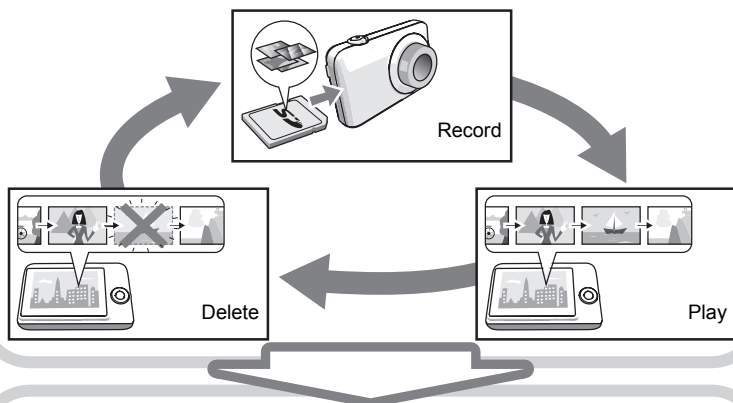

You can use the images you record in a variety of different ways.

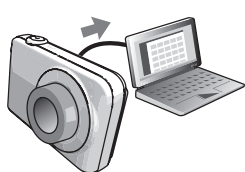

Store images on your computer.

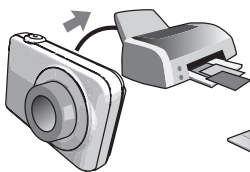

Print images.



Attach images to e-mail.

## What you can do with your CASIO camera

Your CASIO camera is packed with a powerful selection of features and functions to make recording of digital images easier, including the following three main functions.

### Hybrid-GPS

The Hybrid-GPS of your camera provides both standard GPS and an autonomous positioning system that uses sensors for positioning indoors and in other locations where GPS satellite waves cannot reach. Hybrid-GPS provides you with the following capabilities.

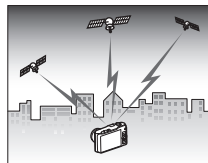

- Recording of current location information (latitude, longitude, camera aiming direction) along with image data (snapshots and movies)
- Recording of the current place name along with image data (snapshots and movies) and direct stamping of the place name in images (snapshots)
- Display of images and shooting locations on a map
- Map-based searches of nearby recommended photogenic spots

See page **91** for more information.

### Premium Auto

Select Premium Auto recording and the camera automatically determines whether you are shooting a subject or scenery, and other conditions. Premium Auto delivers higher image quality than standard Auto.



See page **26** for more information.

## BEST SHOT

Simply select the sample scene you want and the camera sets up automatically. Then all you need to do is press the shutter button for perfect images.



See page **52** for more information.



## First, charge the battery prior to use.

Note that the battery of a newly purchased camera is not charged. Perform the steps under “To charge the battery” to bring the battery to a full charge.

- Your camera requires a special CASIO rechargeable lithium ion battery (NP-90) for power. Never try to use any other type of battery.

### To charge the battery

- 1. Positioning the positive  $\oplus$  and negative  $\ominus$  terminals of the battery with those of the charger unit, load the battery into the charger unit.**

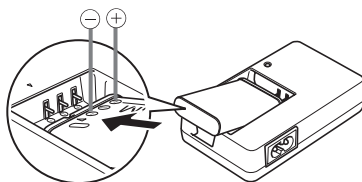

- 2. Plug the charger unit into a household power outlet.**

About 200 minutes are required to reach full charge. The [CHARGE] lamp will go out when charging is complete. Unplug the power cord from the power outlet and then remove the battery from the charger.

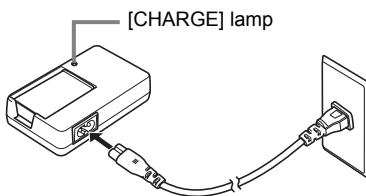

Lamp Status	Description
Lit Red	Charging
Flashing Red	Abnormal ambient temperature, charger problem, or battery problem (page 161)
Off	Charging complete

## Other Charging Precautions

- Use the special charger (BC-90L) to charge the special lithium ion battery (NP-90). Never use any other type of charger device. Attempting to use a different charger can result in an unexpected accident.
- A battery that is still warm due to normal use may not charge fully. Give the battery time to cool before charging it.
- A battery discharges slightly even when it is not loaded in the camera. Because of this, it is recommended that you charge the battery immediately before you need to use it.
- Charging the camera's battery may cause interference with TV and radio reception. If this happens, plug the charger into an outlet that is further away from the TV or radio.
- Actual charging time depends on current battery capacity and charging conditions.

## To load the battery

### 1. Open the battery cover.

Slide the battery cover slider towards OPEN and then open it as indicated by the arrows in the illustration.

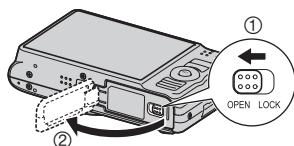

### 2. Load the battery.

With the EXILIM logo on the battery facing downwards (in the direction of the lens), hold the stopper next to the battery in the direction indicated by the arrow as you slide the battery into the camera. Press the battery in until the stopper secures it in place.

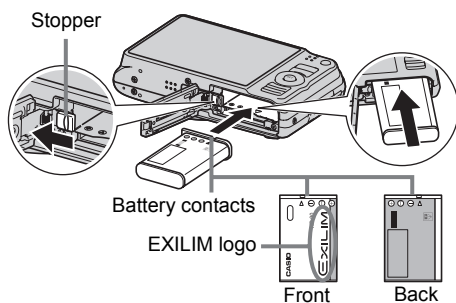

### 3. Close the battery cover.



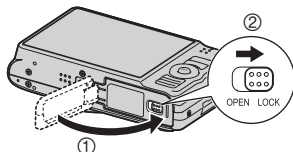

Close the battery cover and then shift the slider towards LOCK.

- For information about how to replace the battery, see page 161.



### Checking Remaining Battery Power

As battery power is consumed, a battery indicator on the monitor screen indicates remaining power as shown below.

Remaining Power	High ←————→ Low
Battery Indicator	 →  →  → 
Indicator Color	Cyan → Amber → Red → Red

 indicates battery power is low. Charge the battery as soon as possible.

Recording is not possible when  is indicated. Charge the battery immediately.

- The level shown by the battery indicator may change when you switch between the REC mode and PLAY mode.
- Leaving the camera for about 30 days with no power supplied while the battery is dead will cause its date and time settings to be cleared. A message telling you to configure time and date settings will appear the next time you turn on the camera after restoring power. When this happens, configure date and time settings (page 146).
- See page 183 for information about battery life and number of shots.

### Battery Power Conservation Tips

- When you do not need to use the flash, select  (Flash Off) for the flash setting (page 37).
- Enable the Auto Power Off and the Sleep features to protect against wasting battery power when you forget to turn off the camera (pages 147, 148).
- Select “Off” for “Continuous AF” (page 60).
- If you do not want to use the GPS function, select “Off” for the “GPS” setting (page 92).

## Configuring Basic Settings the First Time You Turn On the Camera

The first time you load a battery into the camera, a screen appears for configuring the display language, date, and time settings. Failure to set the date and time correctly will cause the wrong date and time data to be recorded with images.

### **IMPORTANT!**

- A screen for language selection will not appear in step 2 of the procedure below if you purchased a camera intended for the Japanese market. To change the display language from Japanese in this case, use the procedure under “Specifying the Display Language (Language)” (page 147). Note that a version of this manual in the language you select may not be included with a camera intended for the Japanese market.
- Camera models sold in certain geographic areas may not support display language selection.

**1. Press [ON/OFF] (Power) to turn on the camera.**

**2. Use [▲], [▼], [◀], and [▶] to select the language you want and then press [SET].**

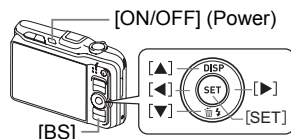

**3. Use [▲] and [▼] to select a date style and then press [SET].**

Example: July, 10, 2012

YY/MM/DD → 12/7/10

DD/MM/YY → 10/7/12

MM/DD/YY → 7/10/12

**4. Set the date and the time.**

Use [◀] and [▶] to select the setting you want to change and then use [▲] and [▼] to change it. To switch between 12-hour and 24-hour format, press [BS].



**5. After setting the date and time, use [◀] and [▶] to select “Apply” and then press [SET].**

---

**6. Use [▲] and [▼] to select “Auto” or “Premium Auto” as the auto recording mode (page 26) and then press [SET].**

- After configuring the auto recording mode setting you want here, you can change the current auto recording setting by selecting the “Auto” or “Premium Auto” BEST SHOT scene (page 26).

If you make a mistake configuring display language, date, or time settings with the above procedure, refer to the following pages for information about how to correct the settings.

- Display language: Page 147
- Date and time: Page 146

**NOTE**

- Each country controls its local time offset and the use of summer time, and so they are subject to change.
- Removing the battery from the camera too soon after configuring time and date settings for the first time can cause the settings to be reset to their factory defaults. Do not remove the battery for at least 24 hours after configuring settings.

## Preparing a Memory Card

Though the camera has built-in memory that can be used to store images and movies, you probably will want to purchase a commercially available memory card for greater capacity. The camera does not come with a memory card. Images and movies recorded while a memory card is loaded are saved to the memory card. When no memory card is loaded, images and movies are saved to built-in memory.

- For information about memory card capacities, see page 179.

## Supported Memory Cards

- SD Memory Card
- SDHC Memory Card
- SDXC Memory Card



Use one of the above types of memory card.

## To load a memory card

- 1. Press [ON/OFF] (Power) to turn off the camera and then open the battery cover.**

Slide the battery cover slider towards OPEN and then open it as indicated by the arrows in the illustration.

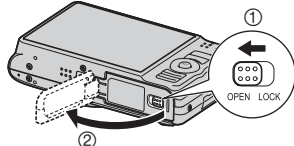

- 2. Load a memory card.**

Positioning the memory card so its front is facing upwards (towards the monitor screen side of the camera), slide it into the card slot all the way in until you hear it click securely into place.

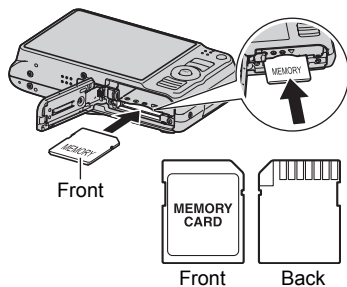

- 3. Close the battery cover.**

Close the battery cover and then shift the slider towards LOCK.

- For information about how to replace the memory card, see page 163.

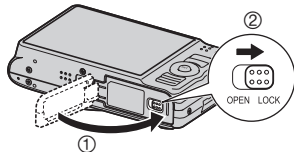

## **IMPORTANT!**

- Never insert anything besides a supported memory card (page 22) into the memory card slot.
- Should water or any foreign object ever get into the card slot, immediately turn off the camera, remove the battery, and contact your retailer or nearest CASIO authorized service center.

## **To format (initialize) a new memory card**

---

You need to format a new memory card before using it for the first time.

- 1. Turn on the camera and press [MENU].**

---

- 2. Select the “Set Up” tab, select “Format” and then press [▶].**

---

- 3. Use [▲] and [▼] to select “Format” and then press [SET].**

## **IMPORTANT!**

- Formatting a memory card that already has snapshots or other files on it, will delete its contents. Normally you do not need to format a memory card again. However, if storing to a card has slowed down or if you notice any other abnormality, re-format the card.
- Be sure to use the camera to format a memory card. Formatting a memory card on a computer and then using it in the camera can slow down data processing by the camera. In the case of an SD, SDHC, or SDXC memory card, formatting on a computer can result in non-conformity with the SD format, causing problems with compatibility, operation, etc.
- Before formatting a new Eye-Fi card to use it for the first time, copy the Eye-Fi Manager install files to your computer. Do this before formatting the card.

## Turning the Camera On and Off

### To turn power on

<b>To turn on power and enter the REC mode</b>	Press [ON/OFF] (Power) or [RECORD] (REC). <ul style="list-style-type: none"><li>The back lamp will light green momentarily and the lens will extend out of the camera (page 26).</li></ul>
<b>To turn on power and enter the PLAY mode</b>	Press [PLAY] (PLAY). <ul style="list-style-type: none"><li>The back lamp will light green momentarily and an image currently stored in camera memory will appear on the monitor screen (page 30).</li></ul>
<b>To turn on power and enter the MAP mode</b>	Press [MAP] (MAP). <ul style="list-style-type: none"><li>The back lamp will light green momentarily, and then the map and images will appear on the monitor screen (page 99).</li></ul>

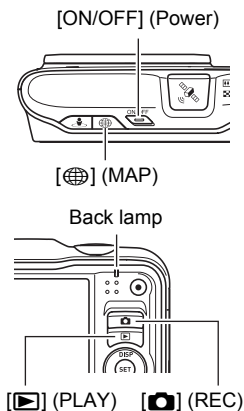

- Take care to ensure that nothing is restricting or coming into contact with the lens as it extends. Holding the lens with your hand so it cannot extend creates the risk of malfunction.
- Pressing [PLAY] (PLAY) while in the REC mode switches to the PLAY mode. The lens retracts about 10 seconds after switching modes.
- The Sleep function or Auto Power Off (pages 147, 148) will turn off power automatically if you do not perform any operation for a preset amount of time.

### To turn off the camera

Press [ON/OFF] (Power).

- You can configure the camera so power does not turn on when you press [RECORD] (REC), [PLAY] (PLAY), or [MAP] (MAP). You also can configure the camera to turn off when you press [RECORD] (REC) or [PLAY] (PLAY) (page 148).



## Holding the Camera Correctly

Your images will not come out clearly if you move the camera when you press the shutter button. When pressing the shutter button, be sure to hold the camera as shown in the illustration below, and keep it still by pressing your arms firmly against your sides as you shoot.

Holding the camera still, carefully press the shutter button and take care to avoid all movement as the shutter releases and for a few moments after it releases. This is especially important when available lighting is low, which slows down the shutter speed.

### Horizontal

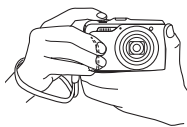

### Vertical

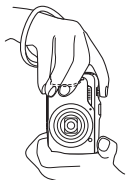

Hold the camera so the flash is above the lens.

### NOTE

- Hold the camera securely in your left hand, with your fingers around the grip on the right front of the camera.
- Take care that your fingers and the strap do not cover any of the areas indicated in the illustration.
- To protect against accidentally dropping the camera, attach the wrist strap and make sure it is around your fingers or wrist while you are operating the camera.
- Never swing the camera around by its strap.
- The supplied strap is intended for use with this camera only. Never use it for any other purpose.

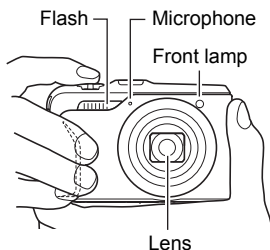

### IMPORTANT!

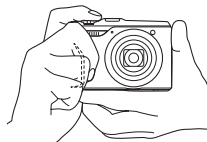

- Take care to ensure that your fingers are not blocking or are not too close to the flash. Fingers can cause unwanted shadows when using the flash.



## To shoot a snapshot

### Selecting an Auto Recording Mode

You can select one of two auto recording modes (Auto or Premium Auto) according to your digital imaging needs.

 <b>Auto</b>	This is the standard Auto recording mode. <ul style="list-style-type: none"><li>• It provides faster operation than Premium Auto recording.</li></ul>
 <b>Premium Auto</b>	With Premium Auto recording, the camera automatically determines whether you are shooting a subject or scenery, and other conditions. Premium Auto recording delivers higher image quality than standard Auto recording. <ul style="list-style-type: none"><li>• Premium Auto recording takes longer to process image data after it is shot than Auto recording.</li><li>• It also requires more power (and runs down the battery quicker) than Auto.</li></ul>

#### 1. Press **[RECALL]** (REC) to turn on the camera.

The camera will enter the REC mode.

#### 2. Press **[BS]**.

This will display a menu of BEST SHOT scenes (page 52).

#### 3. Use **[▲]**, **[▼]**, **[◀]**, and **[▶]** to select the “Auto” or “Premium Auto” BEST SHOT scene and then press **[SET]**.

This will set the Auto Recording Mode.

Auto recording mode icon



Remaining Snapshot Memory Capacity (page 179)

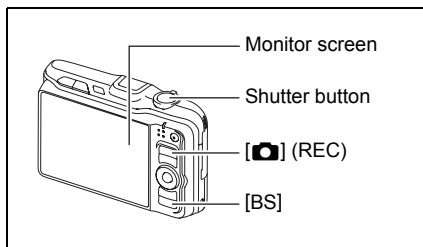

## To shoot a snapshot

### 1. Point the camera at the subject.

If you are using Premium Auto, text will appear in the lower right corner of the monitor screen describing the type of shot the camera has detected.

- You can zoom the image, if you want.

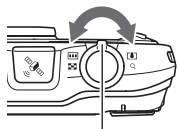

Zoom controller

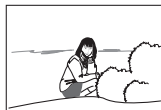

Wide Angle



Telephoto



Appears when the camera detects it is stationary on a tripod.

- When you select "On" for the "GPS" setting (page 92), candidates for the place name of the current location that will be registered to the image based on the latitude and longitude measured by the Hybrid-GPS will appear on the monitor screen. At this time you can register the name of the location where you are shooting to the image. For details, see "Inserting the Place Name into Image Data (Insert Place)" (page 94).

### 2. Half-press the shutter button to focus the image.

When focus is complete, the camera will beep, the back lamp will light green, and the focus frame will turn green.

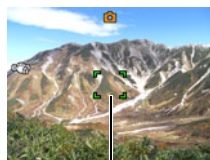
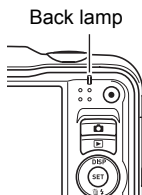

Focus frame

#### Half-press

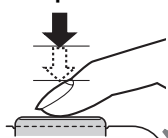

Press lightly until the button stops.

Beep, beep (Image is in focus.)

When you half-press the shutter button, the camera automatically adjusts exposure and focuses on the subject it is currently pointed at. Mastering how much pressure is required for a half-press and a full-press of the shutter button is an important technique for good-looking images.

- The focus frame in the screen shots included in this manual is shown at [ ]. Note that you can change the form of the focus frame, if you want (page 62).

### 3. Continuing to keep the camera still, press the shutter button the rest of the way down.

This records the snapshot.

#### Full-press

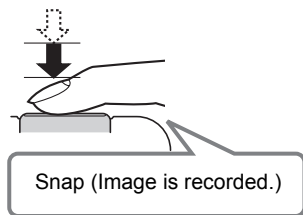

#### Recording a Movie

Press [●] (Movie) to start movie recording. Press [●] (Movie) again to stop movie recording. See page 50 for details.

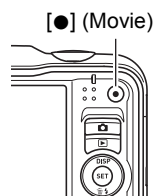

#### ■ If the image does not focus...

If the focus frame stays red and the back lamp is flashing green, it means that the image is not in focus (because the subject is too close, etc.). Re-point the camera at the subject and try to focus again.

#### ■ Shooting with Auto

##### If the subject is not in the center of the frame...

“Focus lock” (page 41) is the name of a technique you can use when you want to shoot an image in which the subject to be focused on is not within the focus frame in the center of the screen.

##### To track the movement of a moving subject

Half-press the shutter button to follow and focus automatically on a moving subject. See “ Tracking” (page 41) for more information.

## ■ Shooting with Premium Auto

- In addition to shutter speed, aperture, and ISO sensitivity, the camera automatically executes the following operation as required when shooting with Premium Auto.
  - Auto Focus is normally performed until you half-press the shutter button.
  - Intelligent AF (Page 41)
  - Face Detection (Page 45)
  - Make-up/Landscape (Pages 67, 68)
- Shooting with Premium Auto can cause vibration and noise to occur due to lens operation. This does not indicate malfunction.
- When Shooting with Premium Auto, the message “Processing Premium Auto. Please wait...” may appear on the monitor screen. If you feel the camera is taking too long to process data, try shooting with standard Auto instead.
- In some cases, Premium Auto may not be able to interpret the shooting environment correctly. If this happens, shoot with standard Auto.

## Viewing Snapshots

Use the following procedure to view snapshots on the camera's monitor screen.

- For information about how to play back movies, see page 73.

### 1. Press [▶] (PLAY) to enter the PLAY mode.

- This will display one of the snapshots currently stored in memory.
- Information about the displayed snapshot also is included (page 179).
- You also can clear the information to view only the snapshot (page 152).
- You can zoom in on the image by sliding the zoom controller towards [🔍] (page 75). If you are recording a snapshot that is very important to you, it is recommended that you zoom the image and check its details after recording it.

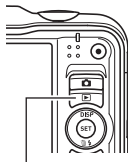

### 2. Use [◀] and [▶] to scroll between images.

- Holding down either button scrolls at high speed.



#### NOTE



- Half-pressing the shutter button while in the PLAY mode or while a menu screen is displayed will switch directly to the REC mode.

## Deleting Snapshots and Movies

If memory becomes full, you can delete snapshots and movies you no longer need to free up storage and record more images.



### IMPORTANT!

- Remember that a file (image) delete operation cannot be undone.
- The delete menu will not appear if you press [▼] (  ) while “On” is selected for the camera’s “ Disabled” setting (page 149). You can delete files only while “Off” is selected for “ Disabled”.

### To delete a single file

1. Press [▶] (PLAY) to enter the PLAY mode and then press [▼] (  ).

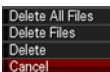

2. Use [◀] and [▶] to scroll through the files until the one you want to delete is displayed.

3. Use [▲] and [▼] to select “Delete” and then press [SET].

- To delete other files, repeat steps 2 and 3.
- To exit the delete operation, press [MENU].

### To delete specific files

1. Press [▶] (PLAY) to enter the PLAY mode and then press [▼] (  ).

2. Use [▲] and [▼] to select “Delete Files” and then press [SET].

- This displays a file selection screen.

3. Use [▲], [▼], [◀], and [▶] to move the selection boundary to the file you want to delete, and then press [SET].

- This will select the check box of the currently selected file.

4. Repeat step 3 to select other files, if you want. After you are finished selecting files, press [BS].

5. Use [▲] and [▼] to select “Yes” and then press [SET].

- This deletes the files you selected.
- To exit the delete operation, press [MENU].

## To delete all files

1. Press [▶] (PLAY) to enter the PLAY mode and then press [▼] (🗑️ ⚡).
2. Use [▲] and [▼] to select “Delete All Files” and then press [SET].
3. Use [▲] and [▼] to select “Yes” and then press [SET] to delete all files.  
This will cause the message “There are no files” to appear.

## Snapshot Shooting Precautions

### Operation

- Never open the battery cover while the back lamp is flashing green. Doing so can result in the image you just shot being saved incorrectly, damage to other images stored in memory, malfunction of the camera, etc.
- If unwanted light is shining directly onto the lens, shade the lens with your hand when shooting an image.

### Monitor Screen when Shooting Snapshots

- Subject brightness conditions can cause monitor screen response to slow and can cause digital noise in the monitor screen image.
- The image that appears on the monitor screen is for image composition. The actual image will be recorded at the quality set for the image quality setting (page 66).

### Shooting Indoors under Fluorescent Lighting

- Minute flickering of fluorescent lighting can affect the brightness or color of an image.



## Auto Focus Restrictions

---

- Any of the following can make proper focus impossible.
  - Solid color wall or other very low contrast subject
  - Strongly back lit subject
  - Very shiny subject
  - Blinds or other subject with a repeating horizontal pattern
  - Multiple subjects at varying distances from the camera
  - Subject in a dark location
  - Subject that is too far away for light from the AF assist lamp to reach
  - Camera movement while shooting
  - Fast-moving subject
  - Subjects outside the focus range of the camera
- If you cannot focus properly, try using focus lock (page 41) or Manual Focus (page 39).

## Using the Control Panel

The Control Panel can be used to configure camera settings.

### 1. In the REC mode, press [SET].

This will select one of the Control Panel icons and display its settings.



### 2. Use [▲] and [▼] to select the setting you want to change.

- |                                      |   |
|--------------------------------------|---|
| ① Image size/Quality* (pages 35, 66) | ⑥ Self-timer (page 44)                                |
| ② Flash (page 37)                    | ⑦ Face Detection/Make-up/Landscape (pages 45, 67, 68) |
| ③ Focus (page 39)                    | ⑧ EV shift (page 46)                                  |
| ④ AF Area (page 41)                  | ⑨ Date/Time (page 47)                                 |
| ⑤ ISO sensitivity (page 43)          |   |

\* Snapshot image quality cannot be changed using the Control Panel.

### 3. Use [◀] and [▶] to change the setting.

### 4. If you want to configure another setting, repeat steps 2 and 3.

### 5. After all of the settings are the way you want, press [SET].

This will apply the settings and return to the REC mode.

#### NOTE

- You also can configure settings other than those listed above (page 58).
- The Control Panel cannot be displayed when certain BEST SHOT scenes are being used.

## Changing the Image Size (Size)

### ■ Pixels

A digital camera image is a collection of small dots called “pixels”. The more pixels there are in an image, the more detail there will be. However, you generally can do with fewer pixels when printing an image (L size) through a print service, attaching an image to e-mail, when viewing the image on a computer, etc.

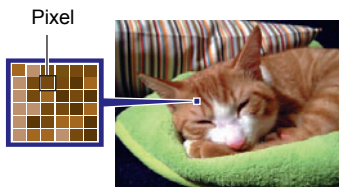

### ■ About image sizes

The size of an image indicates how many pixels it contains, and is expressed as horizontal pixels×vertical pixels.

10M (3648×2736) size image =  
Approximately 10 million pixels

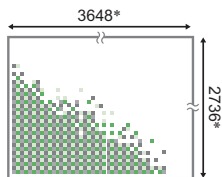

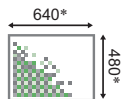

VGA (640×480) size image =  
Approximately 300,000 pixels



\* Unit: pixels

### Image Size Selection Tips

Note that larger images have more pixels, so they take up more memory space.

<b>Large Number of Pixels</b>	More detail, but takes up more memory. Best when you plan to print large-size prints (such as A3 size).	
<b>Small Number of Pixels</b>	Less detail, but takes up less memory. Best when you want to send images by e-mail, etc.	

- For information about image size, image quality, and number of images that can be stored, see page 179.
- For information about movie image size, see page 66.
- For information about resizing existing snapshots, see page 89.

## ■ To select the image size

1. In the REC mode, press [SET].

2. Use [▲] and [▼] to select the top Control Panel option (Image Size).

3. Use [◀] and [▶] to select an image size and then press [SET].

Image Size (Pixels)	Suggested Print Size and Application	Description
14M (4320×3240)	Poster Print	Good detail for better clarity even for images cropped (page 90) from the original
3:2 (4320×2880)	Poster Print	
16:9 (4320×2432)	HDTV	
10M (3648×2736)	Poster Print	Good detail
6M (2816×2112)	A3 Print	
3M (2048×1536)	3.5"×5" Print	Best when preserving memory capacity is relatively more important than image quality.
VGA (640×480)	E Mail	Image files are smaller, which is better when attaching images to e-mail. However, images are relatively coarser.





- The initial factory default image size setting is "14M".
- Selecting "3:2" records images with an aspect ratio of 3:2, which matches the standard aspect ratio of print paper.
- The letters "HDTV" stand for "High Definition Television". An HDTV screen has an aspect ratio of 16:9, which makes them wider than the usual 4:3 aspect ratio of television screens of the past. Your camera can record images that are compatible with the aspect ratio an HDTV screen.
- You should regard the print paper sizes suggested here as guidelines only (200 dpi print resolution).

## Using Flash (Flash)

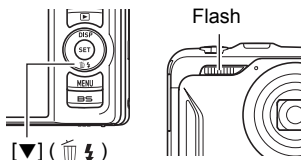
1. In the REC mode, press [▼] (  ) once.

2. Use [◀] and [▶] to select the flash setting you want and then press [SET].



 <b>Auto Flash</b>	Flash fires automatically in accordance with exposure (amount of light and brightness) conditions.
 <b>Flash Off</b>	Flash does not fire.
 <b>Flash On</b>	Flash always fires. This setting can be used to brighten a subject that normally comes out dark due to daylight or backlight (daylight synchro flash).
 <b>Soft Flash</b>	Soft flash always fires, regardless of exposure conditions
 <b>Red Eye Reduction</b>	Flash fires automatically. This type of flash can be used to reduce the chance of redness in the subject's eyes.

3. Press the shutter button to shoot.

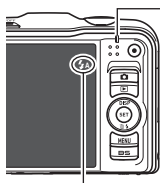

### Back lamp

Flashes orange while the flash is charging to indicate that image recording is disabled.

- You will not be able to take another flash snapshot until the lamp stops flashing orange, which indicates that charging is complete.

 indicates the flash will fire.

- For information about Flash Range, see page 182.

## NOTE

---

- Take care so your fingers and the strap do not block the flash.
- The desired effect may not be obtained when the subject is too far away or too close.
- Flash charging time (page 182) depends on operating conditions (battery condition, ambient temperature, etc.)
- Shooting with flash turned off when lighting is dim results in a slow shutter speed, which can cause image blur due to camera movement. Under such conditions, secure the camera with a tripod, etc.
- With red eye reduction, the flash is fired automatically in accordance with exposure. It does not fire in areas where lighting is bright.
- The presence of outdoor sunlight, fluorescent lighting, or some other light source can cause abnormal image colors.
- Select  (Flash Off) for the flash setting when shooting in areas where flash photograph is prohibited.

### Red-eye Reduction

Using the flash to shoot at night or in a dimly lit room can cause red spots inside the eyes of people who are in the image. This is caused when the light from the flash reflects off of the retina of the eye. When red-eye reduction is selected as the flash mode, the camera fires a pre-flash to cause the irises in the eyes of any people in the image to close, which reduces the chance of red eye.

Note the following important points when using red-eye reduction.

- Red-eye reduction does not work unless the people in the image are looking directly at the camera (flash).
- Red-eye reduction may not work very well if the subjects are located far away from the camera.

### Other Useful Flash Features

- Changing the flash intensity (page 72)

## Selecting a Focus Mode (Focus)

You can select a focus mode setting.

1. In the REC mode, press [SET].
2. Use [▲] and [▼] to select the third Control Panel option from the top (Focus).
3. Use [◀] and [▶] to select the setting you want and then press [SET].

Settings	Type of Shot	Focus Mode		Approximate Focus Range* <sup>1</sup>	
		Snapshot	Movies	Snapshot	Movies
<b>AF</b> Auto Focus	General recording	Automatic	Fixed focal point	Approximately 15 cm to ∞ (infinity) (5.9" to ∞) (Wide Angle)	Fixed distance * <sup>2</sup>
<b>M</b> Macro	Close ups	Automatic		Approximately 7 cm to 50 cm (2.8" to 19.7") (First step zoom from the Widest Angle setting)	
<b>MS</b> Super Macro	Close ups	Automatic		Approximately 7 cm to 50 cm (2.8" to 19.7")	
<b>∞</b> Infinity	Scenery and other distant subjects	Fixed		Infinity	
<b>MF</b> Manual Focus	When you want to focus manually	Manual		Approximately 15 cm to ∞ (infinity)* <sup>2</sup> (5.9" to ∞) (Wide Angle)	

\*1 The focus range is the distance from the lens surface.

\*2 The minimum changes along with the optical zoom setting.

## Super Macro

Super Macro fixes optical zoom at a position that allows you to shoot from the closest distance to the subject. The result is closer and larger subject images.

### NOTE

- Zoom is fixed while Super Macro is selected, so no zoom operation is performed when you slide the zoom controller.

### To focus with manual focus

**1. On the monitor screen, compose the image so the subject you want to focus on is within the yellow boundary.**

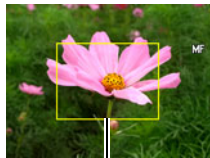

Yellow boundary

**2. Watching the image on the monitor screen use [◀] and [▶] to adjust focus.**

- At this time the image that is within the boundary will enlarge and fill the monitor screen, which aids in focusing. If you do not perform any operation for two seconds while the enlarged image is displayed, the screen in step 1 will re-appear.

### NOTE

- An Auto Macro feature detects how far the subject is from the lens and automatically selects either Macro Focus or Auto Focus accordingly.
- Use of the flash together with Macro Focus can cause the light of the flash to become blocked, which may result in unwanted lens shadows in your image.
- Whenever you perform an optical zoom operation while shooting with Auto Focus, Macro Focus, or Manual Focus, a value will appear on the monitor screen to tell you the focus range, as shown below.

Example: ○○ cm to ∞

\* ○○ is the actual focusing range value.

- When using manual focus to shoot, place name candidates do not appear on the monitor screen, so you cannot select a place name for images (page 94). Perform the following steps if you want to record an image along with the correct place name.

- ① Move to the location where you want to shoot.
- ② Use a focus mode other than manual focus to display candidate place names and select the one you want.
- ③ Return to the manual focus mode and shoot (without changing locations).



## Using Focus Lock

“Focus lock” is a technique you can use when you want to compose an image in which the subject you want to focus on is not within the focus frame in the center of the screen.

- To use focus lock, select “ Spot” for the Auto Focus area (page 41).

**1. Align the monitor screen’s focus frame with the subject you want to focus on and then half-press the shutter button.**

Subject to be focused on

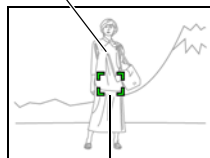

Focus frame

**2. Keeping the shutter button half-pressed (which maintains the focus setting), move the camera to compose the image.**







**3. When you are ready to shoot the image, press the shutter button the rest of the way down.**

### NOTE

- Focus lock also locks exposure (AE).

## Specifying the Auto Focus Area (AF Area)

 <b>Intelligent</b>	The camera automatically determines the focus point on the screen and focuses there (intelligent AF). <ul style="list-style-type: none"><li>• Face detection (page 45) operates automatically.</li></ul>
 <b>Spot</b>	This mode takes readings of a small area in the center of the image. This setting works well with focus lock (page 41).
 <b>Multi</b>	When you half-press the shutter button while this setting selected, the camera will select the optimum Auto Focus area from among nine possible areas. The focus frame of the area where the camera focuses will be displayed in green.
 <b>Tracking</b>	Half-pressing the shutter button focuses on the subject and causes the focus frame to track the movement of the subject.

1. In the REC mode, press [SET].
2. Use [▲] and [▼] to select the fourth Control Panel option from the top (AF Area).
3. Use [◀] and [▶] to select the setting you want and then press [SET].
4. Point the camera at the subject and half-press the shutter button. Wait until the camera adjusts exposure and focus automatically.
5. Press the shutter button the rest of the way down.

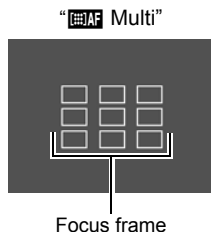
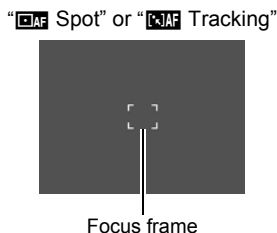

### IMPORTANT!

- Selecting “AF Tracking” can cause vibration and noise to occur due to lens operation while tracking a subject. This does not indicate malfunction.

## Specifying ISO Sensitivity (ISO)

ISO sensitivity is a measure of sensitivity to light.

**1. In the REC mode, press [SET].**

**2. Use [▲] and [▼] to select the fifth Control Panel option from the top (ISO Sensitivity).**

**3. Use [◀] and [▶] to select the setting you want and then press [SET].**



<b>AUTO</b>	Adjusts sensitivity automatically according to conditions		
<b>ISO 80</b>	Lower sensitivity	Slow shutter speed	Less noise
<b>ISO 100</b>	↑ ↓	↑ ↓	↑ ↓
<b>ISO 200</b>			
<b>ISO 400</b>			
<b>ISO 800</b>			
<b>ISO 1600</b>			
<b>ISO 3200</b>	Higher sensitivity	Fast shutter speed (Set for shooting in dimly lit areas.)	Some coarseness (increased digital noise)

- “AUTO” ISO sensitivity always is applied for movies, regardless of the current ISO sensitivity setting.
- Higher ISO sensitivity values tend to result in digital noise in images.

## Using the Self-timer (Self-timer)

With the Self-timer, pressing the shutter button starts a timer. The shutter is released and the image is shot after a fixed amount of time.

1. In the REC mode, press [SET].
2. Use [▲] and [▼] to select the sixth Control Panel option from the top (Self-timer).
3. Use [◀] and [▶] to select the setting you want and then press [SET].

 <b>10sec Self-timer</b>	10-second Self-timer
 <b>2sec Self-timer</b>	2-second Self-timer <ul style="list-style-type: none"><li>• When shooting under conditions that slow down the shutter speed, you can use this setting to prevent image blur due to camera movement.</li></ul>
 <b>X3 Self-timer (Triple Self-timer)</b>	Shoots three images: one image 10 seconds after the shutter button is pressed, and the next two images as soon as the camera is ready after shooting the previous image. How long it takes for the camera to get ready to shoot depends on the image size and quality settings, whether or not a memory card is loaded in the camera, and the flash charge condition.
<b>Self-timer Off</b>	Turns off the Self-timer.

- The front lamp flashes while the Self-timer countdown is in progress.
- You can interrupt an ongoing Self-timer countdown by pressing [SET].

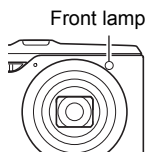

### NOTE

- The Triple Self-timer cannot be used together with the following features. Movie, Make-up Mode, Landscape Mode, some BEST SHOT scenes

## Using Face Detection (Face Detection)

When shooting people, the face detection feature detects the faces of up to ten individuals and adjusts focus and brightness accordingly.

- 1. In the REC mode, press [SET].**

---

- 2. Use [▲] and [▼] to select the third Control Panel option from the bottom (Face Detection).**

---

- 3. Use [◀] and [▶] to select “ Face Detection: On” and then press [SET].**

---

- 4. Point the camera at the subject(s).**

The camera will detect human faces and display a frame around each one.

---

- 5. Half-press the shutter button.**

The camera will focus and the frames around the faces it focuses on will turn green.

---

- 6. Press the shutter button the rest of the way down.**



### **IMPORTANT!**

- The camera performs center focus if it cannot detect a face.
- The only focus mode available while face detection is enabled is Auto Focus (AF).
- Face detection may take a bit longer when you hold the camera sideways.
- Detection of the following types of faces is not supported.
  - Face that is obstructed by hair, sunglasses, a hat, etc., or a face in dark shade
  - A profile or a face that is at an angle
  - A face that is very far away and small, or very close and large
  - A face in an area that is very dark
  - The face of a pet or some other non-human subject
- Face detection cannot be used in combination with any of the following features.
  - Some BEST SHOT scenes
  - Movie Recording
- The AF area setting (page 41) is ignored while face detection is enabled.

## Correcting Image Brightness (EV Shift)

You can manually adjust an image's exposure value (EV value) before shooting it.

- Exposure Compensation Range:  $-2.0\text{EV}$  to  $+2.0\text{EV}$
- Unit:  $1/3\text{EV}$

**1. In the REC mode, press [SET].**

**2. Use [▲] and [▼] to select the second Control Panel option from the bottom (EV Shift).**

**3. Use [◀] and [▶] to adjust the exposure compensation value.**

[▶]: Increases the EV value. A higher EV value is best for light-colored subjects and backlit subjects.

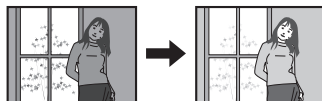

[◀]: Decreases the EV value. A lower EV value is best for dark-color subjects and for shooting outdoors on a clear day.

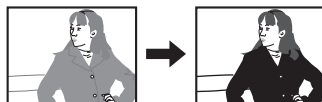

To cancel exposure compensation, change the EV value to 0.0.



Exposure compensation value

**4. Press [SET].**

This applies the exposure compensation value. The exposure compensation value you set remains in effect until you change it or turn off the camera (which causes it to revert to "0.0").

### NOTE

- When shooting under very dark or very bright conditions, you may not be able to obtain satisfactory results even after performing exposure compensation.

## Changing the Control Panel Date/Time Style

1. In the REC mode, press [SET].
2. Use [▲] and [▼] to select the bottom Control Panel option (Date/Time).  
Use [◀] and [▶] to select the date or time.

### NOTE

- You can select either of two display style (page 146) for the date: Month/Day or Day/Month.
- The time is displayed using 24-hour format.

## Shooting with Zoom

Your camera is equipped with various types of zoom: optical zoom, HD Zoom, Single SR Zoom, and digital zoom. The maximum zoom factor depends on the image size setting and the digital zoom on/off settings.

<b>Optical zoom</b>	Changes the lens focal distance.
<b>HD Zoom</b>	Allows greater zoom capabilities by cutting out a portion of the original image and enlarging it.
<b>Single SR Zoom</b>	Applies super resolution technology to suppress image deterioration.
<b>Digital zoom</b>	Digitally processes the center of the image to enlarge it.

1. In the REC mode, slide the zoom controller to zoom.



 Wide Angle



 Telephoto

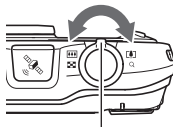

Zoom controller

 (Wide Angle): Reduces the size of the subject and broadens the range.

 (Telephoto): Enlarges the subject and narrows the range.

2. Press the shutter button to shoot the image.

### NOTE

- Use of a tripod is recommended to protect against image blur due to camera movement when shooting with telephoto.
- Performing a zoom operation changes the lens aperture.
- Digital zoom only is available during movie recording. You can adjust the optical zoom setting before you press [●] (Movie) to start movie recording.

## Interpreting the Zoom Bar

During a zoom operation, a zoom bar appears on the monitor screen to show the current zoom setting.

Range where image deterioration is suppressed.  
(optical zoom, HD Zoom, Single SR Zoom)

Deteriorated image range  
(digital zoom)

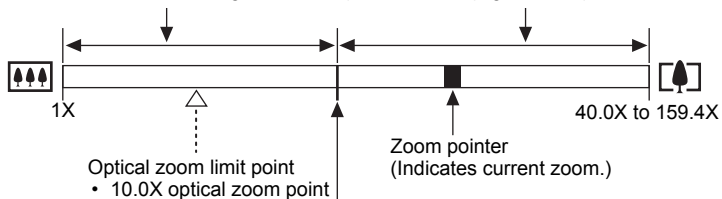



Point from which image deteriorates.

- This point can be anywhere from 15.0X to 101.1X when Single SR Zoom is enabled, or 10.0X to 67.5X when it is disabled.

### Zoom Icon

The appearance of the zoom icon on the monitor screen depends on the zoom factor.

<b>Optical zoom</b>	Not displayed
<b>HD Zoom</b>	Not displayed
<b>Single SR Zoom</b>	
<b>Digital zoom</b>	



## ■ Zoom Factor

The digital zoom factor depends on the image size (page 35) and on whether Single SR Zoom is enabled or disabled.

Image size	Maximum zoom factor where image deterioration can be suppressed		Total maximum zoom factor
	Single SR Zoom: Off	Single SR Zoom: On	
14M	10.0X	15.0X	40.0X
3:2	10.0X	15.0X	40.0X
16:9	10.0X	15.0X	40.0X
10M	11.8X	17.8X	47.4X
6M	15.3X	23.0X	61.3X
3M	21.1X	31.6X	84.3X
VGA	67.5X	101.1X	159.4X

## Zooming with Super Resolution (Single SR Zoom)

Super resolution technology makes it possible to expand the zoom range in which image deterioration is minimized. For information about the effective zoom factor ranges in which Single SR Zoom is effective, see page 49.

1. In the REC mode, press [MENU].
2. Use [◀] and [▶] to select the “Quality” tab.
3. Use [▲] and [▼] to select “Single SR Zoom” and then press [▶].
4. Use [▲] and [▼] to select “On” and then press [SET].

### NOTE

- It also does not work during movie recording.
- The following functions are disabled when shooting with Single SR Zoom.  
Triple Self-timer, Make-up Mode, some BEST SHOT scenes

## To record a movie

### 1. Configure the quality setting for the movie (page 66).

The length of the movie you can record will depend on the quality setting you select.

### 2. In the REC mode, point the camera at the subject and then press [●] (Movie).

This will start recording and display  on the monitor screen.

Movie recording includes monaural audio.

- Immediately after you press [●] (Movie), the camera will focus automatically on the subject in the center of the monitor screen. After this, focus is fixed while movie recording is in progress.

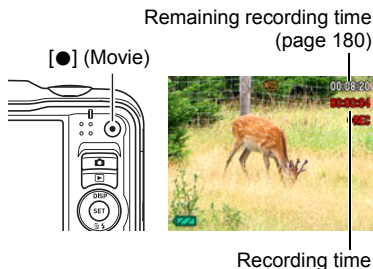

### 3. Press [●] (Movie) again to stop recording.

Movie recording also will stop automatically if memory becomes full before you press [●] (Movie).

- The maximum size allowed for a single movie file is 4GB. Movie recording stops automatically when a file becomes 4GB.

## Shooting with BEST SHOT

With BEST SHOT (page 52), you can select the sample scene that matches the type of movie you are trying to shoot and the camera will change its setup accordingly, for beautiful movies every time. Selecting the BEST SHOT scene named Night Scene, for example, will configure the camera so night scenes appear clearer and brighter.

## Minimizing the Effects of Camera Movement during Movie Recording

You can configure the camera to minimize the effects of camera movement during movie recording (page 61). Note, however, that this does not prevent image blur due to subject movement and it makes the field of view narrower.

## NOTE

- Spending a long time using movie recording will cause the camera to become slightly warm to the touch. This is normal and does not indicate malfunction.
- The camera also records audio. Note the following points when shooting a movie.
  - Take care that the microphone is not blocked by your fingers, etc.
  - Good recording results are not possible when the camera is too far away from what you are trying to record.
  - Operating camera buttons while shooting can cause button noise to be picked up in the audio.
- Shooting a very bright subject can cause a vertical band or a pink cast on the monitor screen image. This does not indicate malfunction.
- When using the camera's built-in memory or certain types of memory cards, it can take too much time to record data, which can result in breaks in the image and/or audio. This condition is indicated by **[RECORDING]** and **[RECORDING]** flashing on the monitor screen. To avoid loss of movie frames, use of a memory card with a maximum transfer speed of at least 10MB per second is recommended (page 164).
- Only digital zoom can be used for zooming during movie recording. Since optical zoom is not possible while recording a movie, zoom as required before pressing **[RECORDING]** (Movie) to start recording.
- The effects of camera movement in an image become more pronounced when you shoot close up or with a large zoom factor. Because of this, use of a tripod is recommended under these conditions.
- Auto Focus and Macro Focus become fixed focus while shooting a movie (page 39).

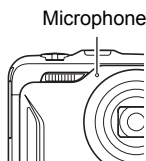

# Using BEST SHOT

## What is BEST SHOT?

BEST SHOT provides you with a collection of sample “scenes” that show a variety of different types of shooting conditions. When you need to change the setup of the camera, simply find the scene that matches what you are trying to achieve, and the camera sets up for it automatically. This helps to minimize the chance of ruined images due to poor exposure and shutter speed settings.

## Some Sample Scenes



			
Portrait	Scenery	Night Scene	Night Scene Portrait

## To shoot an image with BEST SHOT

### 1. In the REC mode, press [BS].

This will display a menu of BEST SHOT scenes.

### 2. Use [▲], [▼], [◀], and [▶] to move the boundary to the scene you want to select.

- The scene menu has multiple pages. Use [▲] and [▼] to scroll between menu pages.
- You can access information about the currently selected scene. See page 53 for details.
- To return to normal snapshot recording, select Scene 1  (Auto). Pressing [MENU] while the scene selection screen or scene information screen is displayed will cause the boundary to jump directly to  (Auto).

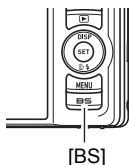

Currently selected scene  
(with boundary)

### 3. Press [SET] to configure the camera with the settings for the currently selected scene.

This returns to the REC mode.

- The settings of the scene you selected remain in effect until you select a different scene.
- To select a different BEST SHOT scene, repeat the above procedure from step 1.

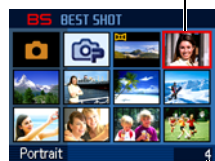

Scene name

Scene number

### 4. Press the shutter button (if you are shooting a snapshot) or [●] (Movie) (if you are shooting a movie).

## NOTE

- The BEST SHOT YouTube scene sets up the camera for recording movies that are optimized for uploading to YouTube. Movies recorded with the YouTube scene are stored in a special folder to make them easy to locate for uploading (page 138).

## ■ Using Scene Information Screen

To find out more about a scene, select it with the boundary on the scene selection screen, and then slide the zoom controller in either direction.

- To return to the scene menu, slide the zoom controller again.
- To scroll between scenes, use [◀] and [▶].
- To configure the camera with the settings for the currently selected scene, press [SET]. To return to the scene information screen for the currently selected BEST SHOT scene, press [BS].

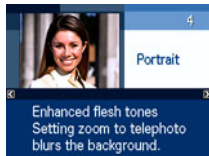

## ■ BEST SHOT Precautions

- Some BEST SHOT scenes cannot be used while recording a movie.
- The following BEST SHOT scene cannot be used while shooting a snapshot.  
For YouTube
- Some scenes like Night Scene and Fireworks results in a slow shutter speed setting. Since a slow shutter speed increases the chance of digital noise in the image, the camera automatically performs a digital noise reduction process when either of these scenes is selected. This means that it will take a bit longer for the image to be saved which is indicated by the back lamp flashing green. Do not perform any key operation during that time. Also, it is a good idea to use a tripod to avoid image blur due to camera movement when shooting at slow shutter speeds.
- BEST SHOT scene images were not shot using this camera.
- Images shot using a BEST SHOT scene may not produce the results you expected due to shooting conditions and other factors.
- You can modify the camera settings that are made after you select a BEST SHOT scene. Note, however, that the BEST SHOT settings revert to their defaults when you select another BEST SHOT scene or turn off the camera.

## Creating Your Own BEST SHOT Setup

You can save up to 999 camera setups as user BEST SHOT scenes for instant recall whenever you need them.

- 1. On the BEST SHOT scene menu, select the scene named “BEST SHOT” (Register User Scene).**
- 2. Use [◀] and [▶] to select the snapshot or movie whose setup you want to save.**
- 3. Use [▲] and [▼] to select “Save”, and then press [SET].**  
Your BEST SHOT scene will be assigned the name “Recall User Scene”, along with a scene number.

### NOTE

- BEST SHOT snapshot scenes can be used for snapshots only and movie scenes can be used for movies only.
- You can check the settings of the currently selected BEST SHOT scene by displaying the camera's setting menus and looking at its settings.
- User snapshot scenes are assigned numbers in the sequence: SU1, SU2, and so on, while movies are assigned numbers in the sequence: MU1, MU2, and so on.
- The following are the settings that are saved for each user snapshot BEST SHOT scene.  
Face Detection, Focus, EV Shift, White Balance, Flash, ISO, Metering, Lighting, Make-up Mode, Landscape Mode, Flash Intensity, Color Filter, Sharpness, Saturation, Contrast
- The following are the settings that are saved for each user movie BEST SHOT scene.  
Focus, EV Shift, White Balance, Color Filter, Sharpness, Saturation, Contrast
- User BEST SHOT scenes are stored in built-in memory (page 138) in the SCENE folder (snapshots) or MSCENE folder (movies).
- Formatting the camera's built-in memory (page 151) deletes all user BEST SHOT scenes.
- Use the following procedure when you want to delete a user BEST SHOT scene.
  - ① Display the information screen (page 53) of the user BEST SHOT scene you want to delete.
  - ② Press [▼] (  ), select “Delete”, and then press [SET].
- The setup of an image recorded with Premium Auto cannot be saved as a user BEST SHOT setup.

## Shooting a Panorama Image (Slide Panorama)

With Slide Panorama, you move the camera to compose and record multiple images, which are then combined to a panorama. This feature lets you shoot a panorama of up to 360 degrees, which is dramatically greater than the physical capabilities of the lens.



- The final panorama image can be one of the two sizes shown below.  
Slide Direction is Right or Left: 5.5M (7680 × 720 pixels)  
Slide Direction is Up or Down: 5.5M (1280 × 4320 pixels)
- Zoom operations are not supporting during Slide Panorama shooting. The zoom setting is fixed at full wide angle.
- You can use Slide Panorama to shoot a horizontal image up to approximately 360 degrees and a vertical image up to approximately 180 degrees.
- If you shoot a horizontal Slide Panorama image that is less than 360 degrees, the image size will become 60, 120, 180, 240, or 300 degrees.

**1. Press [BS] and then select the “Slide Panorama” scene.**

**2. Press [SET] and then use [▲] and [▼] to select the top Control Panel option (Slide Direction).**

**3. Use [◀] and [▶] to select the direction you are planning to move the camera while shooting, and then press [SET].**

You can select one of four directions: Right, Left, Up, or Down.

**4. Point the camera at the start of the panorama and half-press the shutter button to allow the camera to focus automatically.**

**5. Press the shutter button the rest of the way down and a slide cursor will appear on the monitor screen. Slowly move the camera in the direction indicated by the arrow on the screen until the slide cursor reaches the other end of its movement range (i.e. all the way to the right when moving the camera to the right).**



- The camera will start composing the panorama image internally when the slide cursor reached the other end of the movement range.
- Image composing also will start automatically if you stop moving the camera during panorama shooting. After you stop moving the camera, the message “Busy... Please wait...” appears as the camera processes the image. Wait until this message disappears before using the camera. Image shooting is disabled while the message is displayed.

## NOTE

---

- The following conditions are not compatible with Slide Panorama shooting.
  - Subject whose brightness is very different from that of its surroundings due to artificial light, sunlight, etc.
  - Rivers, waves, waterfalls, or other subject with constantly changing patterns
  - Sky, beach, or other subject with continuous patterns
  - Camera too close to the main subject
  - Moving subject
- Slide Panorama may stop part way through in the following cases.
  - Subject or camera movement
  - Camera movement that is too fast or too slow
- Shooting a Slide Panorama image after half-pressing the shutter button to perform Auto Focus may not produce the desired results if there are considerable differences in the brightness, color, and/or focus of the individual images. If this happens, try changing the focus position by focusing on a different subject, etc.
- Since a Slide Panorama image is created by joining multiple images together, there may be some roughness at the point where two images are joined.
- Shooting under a flickering light source (such as fluorescent lighting) may result in uneven brightness and/or coloring in the final Slide Panorama image.
- Shooting in dark surroundings may result in a blurred image or may make Slide Panorama shooting impossible.
- Slowly move the camera at a constant speed in the same direction as the arrow that appears on the monitor screen.
- When moving the camera, try to keep the arrow on the monitor screen as straight as possible.
- The exposure and white balance when shooting Slide Panorama images are fixed at the levels measured when you half-press the shutter button at the beginning of the operation.
- An error message will appear if the camera is unable to successfully record a series of images.
- If you shoot a moving subject, the camera may not be able to compose the panorama image properly.
- With this BEST SHOT scene, the flash setting automatically becomes  (Flash Off).



## Recording a Self-portrait

With this feature, you can shoot your own self-portrait simply by pointing the camera at your face.

BEST SHOT has two self-portrait scenes from which to choose.

- Self-portrait (1 person): Shoots when the face of at least one person, including you, is detected.
- Self-portrait (2 people): Shoots when the faces of at least two people, including you, are detected.

### 1. Press [BS] and then select “Self-portrait (1 person)” or “Self-portrait (2 people)”.

### 2. Press the shutter button all the way down, and point the camera at yourself.

About three seconds after you press the shutter button, the camera will go into Auto Shutter standby and start face detection. The camera will go into Auto Shutter standby and detect the faces of any people in the image.

When the camera is able to detect the number of required individuals, it will release the shutter automatically when it determines there is no image blur.

- The camera will emit a shutter sound and the front lamp will flash twice when the shutter is released.
- To cancel Auto Shutter standby, press [SET].



### **IMPORTANT!**

- If the camera remains in Auto Shutter standby without releasing the shutter, you can record an image by pressing the shutter button all the way down again.
- Shooting with the self-portrait feature may produce a blurred image when shooting in areas where lighting is dim, which results in a very slow shutter speed setting.
- The Auto Power Off (page 148) trigger time is fixed at five minutes while the camera is in Auto Shutter standby. Sleep (page 147) is disabled while Auto Shutter is being used.

# Advanced Settings

The following are menu operations you can use to configure various camera settings.

- You also can use the Control Panel (page 34) to configure some of the settings that appear on the menu screen. Refer to the page references provided in this section for information about configuring settings using the Control Panel.

## Using On-screen Menus

### ■ Example Menu Screen Operation

#### 1. In the REC mode, press [MENU].

This will display the menu screen.

- Menu contents are different in the REC mode and PLAY mode.

#### 2. Use [◀] and [▶] to select the tab where the menu item you want to configure is located.

#### 3. Use [▲] and [▼] to select the menu item you want, and then press [▶].

#### 4. Use [▲] and [▼] to change the setting of the selected menu item.

#### 5. After the setting is the way you want, press [SET] to apply the setting and return to the viewfinder screen.

- Pressing [◀] instead of [SET] applies the selected setting and returns to the menu item selection.
- To configure settings on another tab after pressing [◀] to return to the menu item selection, use [▲] to move the highlighting up to the tabs, and then use [◀] and [▶] to select the tab you want.
- Pressing [MENU] interrupts the menu operation and exits the menu screen.

[▲] [▼] [◀] [▶]

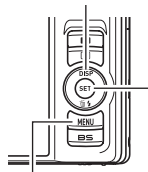

[MENU]

[SET]

Example:

When "Focus" is selected on the "REC" tab

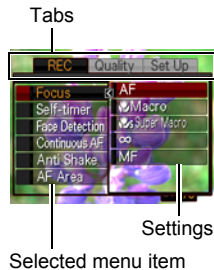

### ★ IMPORTANT!

- Switching from "Auto" to "Premium Auto" (page 26) will make some menu items unavailable.

## ■ Menu Operations in This Manual

Menu operations are represented in this manual as shown below. The following operation is the same one described under “Example Menu Screen Operation” on page 58.

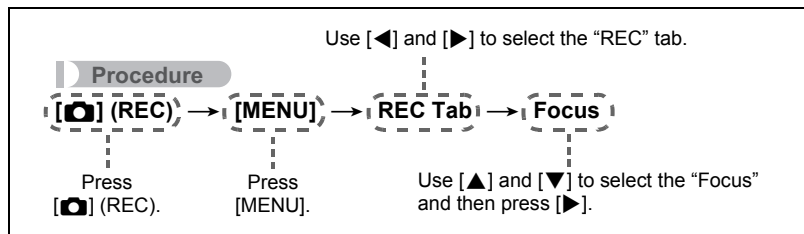

## REC Mode Settings (REC)

### Selecting a Focus Mode (Focus)

#### Procedure

[] (REC) → [MENU] → REC Tab → Focus

For details, see the Control Panel procedure on page 39.

### Using the Self-timer (Self-timer)

#### Procedure

[] (REC) → [MENU] → REC Tab → Self-timer

For details, see the Control Panel procedure on page 44.

### Shooting with Face Detection (Face Detection)

#### Procedure

[] (REC) → [MENU] → REC Tab → Face Detection

For details, see the Control Panel procedure on page 45.

### Shooting with Continuous Auto Focus (Continuous AF)

#### Procedure

[] (REC) → [MENU] → REC Tab → Continuous AF

When shooting a snapshot while “On” is selected for Continuous AF, Auto Focus is performed and focusing is continually updated until you half-press the shutter button.



- Before you half-press the shutter button, the camera focuses at the center of the screen. If “Face Detection” is turned on when you half-press the shutter button, focusing is performed in the area where a face is detected.
- Shooting with Continuous AF can cause vibration and noise to occur due to lens operation. This does not indicate malfunction.

## Reducing the Effects of Camera and Subject Movement (Anti Shake)



### Procedure

[] (REC) → [MENU] → REC Tab → Anti Shake

You can turn on the camera's Anti Shake feature to reduce image blur due to subject movement or camera movement when shooting a moving subject using telephoto, when shooting a fast-moving subject, or when shooting under dim lighting conditions. Your digital camera is equipped with a CCD shift type camera shake correction feature and a high-sensitivity anti image blur feature. These two features work in concert to minimize the effects of hand and subject movement.

 <b>Auto</b>	Minimizes the effects of hand and subject movement.
 <b>DEMO</b>	Half-pressing the shutter button demonstrates the effect of Anti Shake. However, the image is not recorded.
<b>Off</b>	Turns off Anti Shake settings

### NOTE

- Only Camera Stabilizer can be used during movie recording.
- ISO sensitivity, aperture, and shutter speed do not appear on the monitor screen when you half-press the shutter button while " Auto" is selected. These values will appear briefly, however, in the preview image that is displayed immediately after you shoot a snapshot.
- Shooting while " Auto" is selected can cause an image to appear somewhat coarser than normal and can cause slight deterioration of image resolution.
- Anti Shake may not be able to eliminate the effects of camera or subject movement when movement is severe.
- Anti Shake may not work properly when the camera is mounted on a tripod. Turn off Anti Shake.

## Specifying the Auto Focus Area (AF Area)

### Procedure

[] (REC) → [MENU] → REC Tab → AF Area

For details, see the Control Panel procedure on page 41.

## Using the Auto Focus Assist Light (AF Assist Light)

### Procedure

[📷] (REC) → [MENU] → REC Tab → AF Assist Light

Half-pressing the shutter button while this setting is selected causes the front lamp to light, which provides illumination for focusing in areas where lighting is dim. Leaving this function turned off is recommended when shooting portraits from short distances, etc.

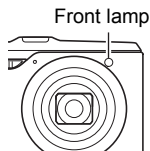

### IMPORTANT!

- Never look directly into the front lamp while it is lit.

## Changing the Focus Frame Shape (Focus Frame)

### Procedure

[📷] (REC) → [MENU] → REC Tab → Focus Frame

You can use this procedure to select from among five different shapes, including a heart shape, for the focus frame.

Settings	[ ]	♡	✿	⊕	✿
		Random			

### NOTE

- Half-pressing the shutter button will cause the focus frame to change one of the shapes shown below.

Focus successful	♡	✿	⊕	✿
Focus not successful	💔	✿	⊕	✗

- While "Random" is selected, one of the four focus frames is selected randomly whenever the camera is turned on.
- When shooting with face detection, the frame shape is [ ].

## Turning Digital Zoom On or Off (Digital Zoom)

---

### Procedure

[] (REC) → [MENU] → REC Tab → Digital Zoom

You can use this setting to turn digital zoom on or off. When digital zoom is turned off, operating the zoom controller zooms the image with optical zoom only.

## Displaying the On-screen Grid (Grid)

---

### Procedure

[] (REC) → [MENU] → REC Tab → Grid

The on-screen grid can be displayed on the REC mode monitor screen for easy vertical and horizontal alignment when composing images.

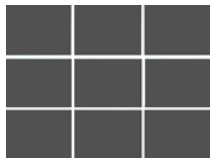

## Turning on Image Review (Review)

---

### Procedure

[] (REC) → [MENU] → REC Tab → Review

While Review is turned on, the camera will display a image for about one second immediately after you press the shutter button to record it.

## Using Icon Help (Icon Help)

---

### Procedure

[] (REC) → [MENU] → REC Tab → Icon Help

While Icon Help is turned on, a textual description will appear on the display for certain icons when you change auto recording mode.

### Function Supported by Icon Help

- Auto recording mode

## Configuring Power On Default Settings (Memory)

### Procedure

[] (REC) → [MENU] → REC Tab → Memory

When you turn off the camera, it remembers the current settings of all enabled memory items and restores them when you turn it back on. Any memory item that is disabled will be returned to its initial default setting whenever you turn off the camera.

Setting	Disabled (Initial Default Setting)	Enabled
BEST SHOT	Snapshot (Auto)	Setting at power off
Effect	Off	
Flash	Auto	
Focus	AF (Auto Focus)	
White Balance	Auto	
ISO	Auto	
AF Area	Spot	
Metering	Multi	
Self-timer	Off	
Flash Intensity	0	
Single SR Quality	Off	
Single SR Zoom	On	
Digital Zoom	On	
MF Position	Position before manual focus was selected.	
Zoom Position*	Full wide	

\* Optical zoom setting only.

- If you turn the camera power off and then back on while the BEST SHOT memory item is enabled, all of the other memory items (except for zoom position) are initialized to the currently selected BEST SHOT sample scene setup, regardless of the enabled/disabled status of the other memory items.



## Image Quality Settings (Quality)

### Shooting Snapshots of better Texture and Sharpness (Single SR Quality)

#### Procedure

[] (REC) → [MENU] → Quality Tab → Single SR Quality

Super resolution technology is used to categorize an image into three parts: an outline part, a fine pattern part, and a flat part, and then perform the optimum process required by each part to increase texture and sharpness.

- A  icon is displayed when the “Single SR Quality” setting is “On”.
- Single SR Quality is enabled for the entire zoom range, including digital zoom.
- It does not work during movie recording.
- The following functions are disabled when shooting with Single SR Quality.  
Triple Self-timer, Make-up Mode, some BEST SHOT scenes

### Zooming with Super Resolution (Single SR Zoom)

#### Procedure

[] (REC) → [MENU] → Quality Tab → Single SR Zoom

See page 49 for details.

### Specifying Snapshot Size (Size)

#### Procedure

[] (REC) → [MENU] → Quality Tab → Size

For details, see the Control Panel procedure on page 36.

## Specifying Snapshot Image Quality (Quality (Snapshot))

### Procedure

[] (REC) → [MENU] → Quality Tab → [] Quality (Snapshot)

<b>Fine</b>	Gives image quality priority.
<b>Normal</b>	Normal

- The “Fine” setting helps to bring out details when shooting a finely detailed image of nature that includes dense tree branches or leaves, or an image of a complex pattern.
- Memory capacity (the number of images you can record) will be affected by the quality settings you configure (page 179).

## Specifying Movie Image Quality (Quality (Movie))

### Procedure

[] (REC) → [MENU] → Quality Tab → [] Quality (Movie)

Movie image quality is a standard that determines the detail, smoothness, and clarity of a movie during playback. Shooting with the high-quality (HD) setting will result in better image quality, but it also shortens the amount of time you can shoot.

Image Quality (Pixels)		Approximate Data Rate	Frame Rate
HD	1280×720	10.9 Megabits/second	30 frames/second
STD	640×480	3.8 Megabits/second	30 frames/second

- The 16:9 aspect ratio is available when “HD” is selected as the image quality.
- Memory capacity (Movie recording time you can shoot) will be affected by the quality settings you configure (page 180).

## Recording Beautiful Images of People and Scenery (Effect)

### Procedure

[] (REC) → [MENU] → Quality Tab → Effect

When either mode described below is selected, the camera will automatically touch up people and scenery to help ensure beautiful images every time.

<b>Make-up</b>	This mode smoothes the skin texture of the subject and softens facial shadows caused by harsh sunlight for better looking portraits.
<b>Landscape</b>	This mode makes colors more vivid, filters haze, and performs other processing that enhances the beauty of natural scenery.

### ■ Shooting with the Make-up Mode (Make-up)

#### 1. Enter the Make-up Mode

- Entering the Make-up Mode causes the  to appear on the Control Panel.



Make-up icon

#### 3. Use [◀] and [▶] to select “Make-up Level” (third Control Panel option from the bottom), and then press [SET].



- You can set one of 13 levels in the range of “0 (Off)” (no correction) to “+12 (Max.)” (maximum correction). The larger the value, the greater the processing that is performed.

#### 4. Point the camera at the subject(s).

The camera will detect human faces and display a frame around each one.

#### 5. Half-press the shutter button.

The camera will focus on the face, which will cause frames around it to turn green.

#### 6. When you are ready to shoot, press the shutter button all the way down.

## ■ Shooting Beautiful Scenery Images (Landscape)

### 1. Enter the Landscape Mode

- Entering the Landscape Mode causes the  to appear on the Control Panel.



Landscape Icon

### 2. Press [SET].

### 3. Use [◀] and [▶] to select the Landscape Mode setting (third Control Panel option from the bottom), and then press [SET].



<b>Vivid Landscape</b>	Enhances colors to produce a clearer, more vivid landscape image.
<b>Mist Removal</b>	Corrects for misty and cloudy conditions for scenery images that appear as if they were shot on a clear day.

- Available level settings are “+1” (Weak) and “+2” (Strong).

### 4. Point the camera at the scenery you want to record.

### 5. Press the shutter button to shoot.

#### NOTE

- The Make-up Mode and Landscape Mode cannot be used during movie recording.
- The following functions cannot be used together with the Make-up Mode:  
Triple Self-timer, Face Detection, Landscape Mode, Some BEST SHOT scenes
- The following functions are disabled while the camera is in the Landscape Mode:  
Triple Self-timer, Make-up Mode, Face Detection, Lighting, Color Filter, Sharpness, Saturation, Contrast, Some BEST SHOT scenes
- Switching from “Auto” to “Premium Auto” (page 26) causes the Make-up and/or Landscape Mode features to be applied automatically. Because of this, you cannot enter the Make-up Mode or Landscape Mode while you are using Premium Auto.

## Correcting Image Brightness (EV Shift)

### Procedure

[] (REC) → [MENU] → Quality Tab → EV Shift

For details, see the Control Panel procedure on page 46.

## Controlling White Balance (White Balance)

### Procedure

[] (REC) → [MENU] → Quality Tab → White Balance

You can adjust white balance to match the source of light available where you are shooting and avoid the blue cast that results when shooting outdoors when it is cloudy, and the green cast that results when shooting under fluorescent lighting.

<b>Auto</b>	Configures the camera to adjust white balance automatically
(Daylight)	For shooting outdoors on a clear day
(Overcast)	For shooting outdoors on an overcast rainy day, in the shade, etc.
(Shade)	For shooting on a clear day in the shade of trees or buildings
(Day White Fluorescent)	For shooting under white or day white fluorescent lighting
(Daylight Fluorescent)	For shooting under daylight fluorescent lighting
(Tungsten)	For shooting under light bulb lighting
<b>Manual</b>	<p>For configuring the camera manually to suit a particular light source.</p> <p>① Select "Manual".</p> <p>② Under the lighting conditions you plan to use when shooting, point the camera at a blank white piece of paper so it fills the entire monitor screen and then press the shutter button.</p> <p>③ Press [SET].</p> <p>The white balance setting is retained even if you turn off the camera.</p>

Blank white paper

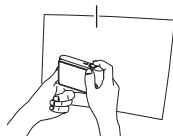

- When "Auto" is selected for the white balance setting, the camera automatically determines the white point of the subject. Certain subject colors and light source conditions can cause problems when the camera tries to determine the white point, which makes proper white balance adjustment impossible. If this happens, select the white balance setting that matches your shooting conditions (Daylight, Overcast, etc.)

## Specifying ISO Sensitivity (ISO)

### Procedure

[] (REC) → [MENU] → Quality Tab → ISO



For details, see the Control Panel procedure on page 43.

## Specifying the Metering Mode (Metering)

### Procedure

[] (REC) → [MENU] → Quality Tab → Metering

The metering mode determines what part of the subject is metered for exposure.

 <b>Multi</b>	Multi-pattern metering divides the image into sections and measures the light in each section for a balanced exposure reading. This type of metering provides error-free exposure settings for a wide range of shooting conditions.
 <b>Center Weighted</b>	Center weighted metering concentrates on the center of the focus area to measure light. This type of metering is best when you want some level of control over contrast.
 <b>Spot</b>	Spot metering takes readings at a very small area. Use this metering method when you want exposure to be set according to the brightness of a particular subject, without being affected by surrounding conditions.

- The currently selected metering mode is indicated by an icon on the snapshot screen. No icon is displayed when " Multi" is selected as the metering mode.

## Optimizing Image Brightness (Lighting)

---

### Procedure

[CAMERA] (REC) → [MENU] → **Quality Tab** → **Lighting**

You can use this setting to optimize the balance between bright areas and dark areas when shooting images.

<b>On</b>	Performs brightness correction. When this option is selected, it takes longer for the image to be stored after the shutter button is pressed.
<b>Off</b>	Does not perform brightness correction.

- You also can optimize the balance between bright areas and dark areas in existing images (page 85).

## Using Built-in Color Filters (Color Filter)

---

### Procedure

[CAMERA] (REC) → [MENU] → **Quality Tab** → **Color Filter**

Settings: Off, B/W, Sepia, Red, Green, Blue, Yellow, Pink, and Purple

## Controlling Image Sharpness (Sharpness)

---

### Procedure

[CAMERA] (REC) → [MENU] → **Quality Tab** → **Sharpness**

You can specify one of five sharpness settings from +2 (sharpest) to -2 (least sharp).

## Controlling Color Saturation (Saturation)

---

### Procedure

[CAMERA] (REC) → [MENU] → **Quality Tab** → **Saturation**

You can specify one of five saturation settings from +2 (most saturated) to -2 (least saturated).

## Adjusting Image Contrast (Contrast)

---

### Procedure

**[CAMERA] (REC) → [MENU] → Quality Tab → Contrast**

You can specify one of five contrast settings from +2 (most contrast between light and dark) to -2 (least contrast between light and dark).

## Specifying Flash Intensity (Flash Intensity)

---

### Procedure

**[CAMERA] (REC) → [MENU] → Quality Tab → Flash Intensity**

You can specify one of five flash intensity settings, from -2 (weakest) to +2 (strongest).

- Flash intensity may not change when the subject is too far away or too close.



# Viewing Snapshots and Movies

## Viewing Snapshots

See page 30 for the procedure for viewing snapshots.

## Viewing a Movie

1. Press [▶] (PLAY) and then use [◀] and [▶] to display the movie you want to view.
2. Press [SET] to start playback.



### Movie Playback Controls

<b>Fast forward/ fast reverse</b>	[◀] [▶] <ul style="list-style-type: none"><li>• Each press of either button increases the speed of the fast forward or fast reverse operation.</li><li>• To return to normal playback speed, press [SET].</li></ul>
<b>Play/pause</b>	[SET]
<b>1 frame forward/ back</b>	[◀] [▶] <ul style="list-style-type: none"><li>• Holding down either button scrolls continuously.</li><li>• Image scrolling is not supported during playback in the MAP mode.</li></ul>
<b>Volume adjustment</b>	Press [▼] and then press [▲] [▼]. <ul style="list-style-type: none"><li>• Volume can be adjusted only while movie playback is in progress.</li></ul>
<b>Information display on/off</b>	[▲] (DISP)
<b>Zoom</b>	Slide the zoom controller in the direction of [⏏] (Q). <ul style="list-style-type: none"><li>• You can use [▲], [▼], [◀], and [▶] to scroll the zoomed image on the monitor screen. You can zoom a movie image up to 4.5 times normal size.</li><li>• Zooming is not supported during playback in the MAP mode.</li></ul>
<b>Stop playback</b>	[MENU]

- Playback may not be possible for movies not recorded with this camera.

## Viewing a Panorama Image

1. Press [▶] (PLAY), and then use [◀] and [▶] to display the panorama images you want to view.
2. Press [SET] to start playback of the panorama.  
Panorama playback causes the image to scroll left, right, up, or down.



### Playback Controls

To start or pause playback	[SET]
To advance scroll while paused	[◀] [▶] (When the slide direction is left or right.) [▲] [▼] (When the slide direction is up or down.) <ul style="list-style-type: none"><li>• Holding down any button scrolls continuously.</li><li>• Scrolling is not supported during MAP mode playback.</li></ul>
To hide or show display information	[▲] (DISP)
To stop playback	[MENU]

- The following functions cannot be performed on a panorama image.  
Dynamic Photo, Movie Converter, MOTION PRINT, Movie Editing, Trimming, Resize

## Zooming an On-screen Image

1. In the PLAY mode, use [◀] and [▶] to scroll through the images until the one you want is displayed.

2. Slide the zoom controller towards [🔍] (🔍) to zoom.

You can use [▲], [▼], [◀], and [▶] to scroll the zoomed image on the monitor screen. Slide the zoom controller towards [🔍] to unzoom the image.

- When monitor screen contents are turned on, a graphic in the lower right corner of the screen shows what part of the zoomed image is currently displayed.
- To exit the zoom screen, press [MENU] or [BS].
- Though the maximum image zoom factor is 8X, certain image sizes may not allow zooming up to the full 8X.

- Pressing [SET] will lock the current zoom factor for the on-screen image. You can then use [◀] and [▶] to scroll between images, using the same zoom factor. Pressing [SET] again will unlock the zoom factor and allow you to use [▲], [▼], [◀] and [▶] to move around the currently displayed images.

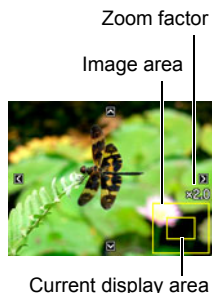

## Displaying the Image Menu

1. In the PLAY mode, slide the zoom controller towards [🔍] (🔍).

Use [▲], [▼], [◀] and [▶] to move the selection boundary around the image menu.

To view a particular image, use [▲], [▼], [◀], or [▶] to move the selection boundary to the image you want and then press [SET].



## Displaying Images in the Calendar Screen

### 1. In the PLAY mode, slide the zoom controller towards () twice.

This will display the calendar screen that shows the first image recorded on each day.

To display the first image recorded on a particular day, use [ $\blacktriangle$ ], [ $\blacktriangledown$ ], [ $\blacktriangleleft$ ], and [ $\blacktriangleright$ ] to move the selection boundary to the day you want and then press [SET].

To exit the calendar screen, press [MENU] or [BS].

- If you save an image using any one of the following functions, the image will appear in the calendar on the date that you last saved it.



Lighting, White Balance, Brightness, Resizing, Trimming, Copy, MOTION PRINT

If you edit the date and time of an image, the image still will appear on the date it was originally recorded.

## Viewing Snapshots and Movies on a TV Screen

### 1. Use the AV cable that comes with the camera to connect it to the TV.

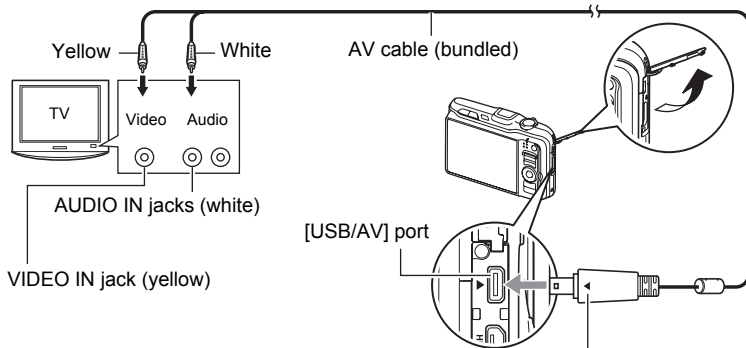

Making sure that the  $\blacktriangleright$  mark on the camera is aligned with the  $\blacktriangleleft$  mark of the AV cable connector, connect the cable to the camera.

- Make sure that you insert the cable connector into the USB/AV port until you feel it click securely into place. Failure to insert the connector fully can result in poor communication or malfunction.
- Note that even while the connector is fully inserted, you still will be able to see the metal part of the connector as shown in the illustration.

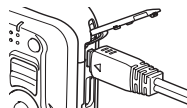

---

## 2. Turn on the TV and select its video input mode.

If the TV has more than one video input, select the one where the camera is connected.

---

## 3. Press [▶] (PLAY) to turn on the camera.

This will cause an image to appear on the TV screen, without anything appearing on the camera's monitor screen.

- Pressing [ON/OFF] (Power) or [📷] (REC) will not turn on the camera while the AV cable is connected.
- You also can change the aspect ratio of the screen and the video output system (page 150).

---

## 4. Now you can display images and play back movies as you normally do.



### **IMPORTANT!**

- Before connecting to a TV to display images, be sure to configure the camera's [📷] (REC) and [▶] (PLAY) buttons for "Power On" or "Power On/Off" (page 148).
- Audio is initially output by the camera at maximum volume. When you first start displaying images, set the TV volume control at a relatively low level and then adjust it as required.

---

### **NOTE**

- Audio is monaural.
- Certain TVs may cut off part of the images.
- All icons and indicators that appear on the monitor screen also appear on the TV screen. You can use [▲] (DISP) to change the display contents.

## Viewing High-quality Movies on a Hi-Vision Television

Use a commercially available HDMI cable to connect the camera to the TV. For information about playback, see page 76.

- Use a commercially available HDMI cable that is marked with the logo shown to the right.

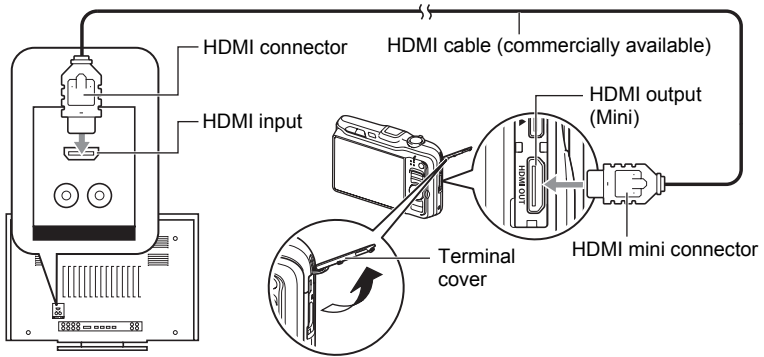

### **IMPORTANT!**

- Output to a TV is not supported in the REC mode.

### **NOTE**

- Use a HDMI cable that with a plug that is compatible with the camera's HDMI mini connector on one end, and a plug that is compatible with your TV's HDMI connector on the other end.
- Proper image and/or audio output and other operations may not be possible with some devices.
- Connecting the camera to the HDMI connector of another device can damage both the camera and the other device. Never connect two HDMI output connectors to each other.
- Make sure that the camera is turned off before plugging in or unplugging the cable. Check the user documentation that comes with the TV for information about requirements before plugging into or unplugging from the TV.
- When cables are connected to both the USB/AV port and the HDMI output connector, the HDMI output connector connection is given priority.
- Disconnect the HDMI cable when you are not using HDMI output. The camera's monitor screen may not operate normally while the HDMI cable is connected.
- Audio is monaural.
- Some TVs may not be able to output images and/or audio correctly.
- Audio is initially output by the camera at maximum volume. When you first start displaying images, set the TV volume control at a relatively low level and then adjust it as required.

## ■ Selecting the HDMI Terminal Output Method (HDMI Output)

### Procedure

#### [MENU] → Set Up Tab → HDMI Output

Use this setting to select the digital signal format when connecting to a TV with an HDMI cable.

<b>Auto</b>	This setting will cause the format to change automatically in accordance with the connected TV. Normally, you should use this mode.
<b>1080i</b>	1080i format output*
<b>480p</b>	480p format output
<b>576p</b>	576p format output

\* 1080i corresponds to 1080 60i, but not 1080 50i. Because of this, the required output method may be 576p when outputting to a digital TV in a PAL reception area that does not support 1080i 60i. If you are in a PAL reception area and nothing is displayed automatically, change the setting to 576p.

- If an image does not appear when “Auto” is selected as the output method, try changing this setting to something else.

### Recording Camera Images to a DVD Recorder or Video Deck

Use one of the following methods to connect the camera to the recording device using the camera's bundled AV cable.

- DVD recorder or video deck: Connect to the VIDEO IN and AUDIO IN terminals.
- Camera: USB/AV port

You can play a slideshow of snapshots and movies on the camera and record it on a DVD or video tape. You can record movies by selecting “ Only” for the slideshow “Images” setting (page 80). When recording images to an external device, use [▲] (DISP) to clear all indicators from the monitor screen (page 152).

For information about connecting a monitor to the recording device and about how to record, see the user documentation that comes with the recording device you are using.

## Other Playback Functions (PLAY)

This section explains menu items that you can use to configure settings and perform other playback operations.

For information about menu operations, see page 58.

### Playing a Slideshow on the Camera (Slideshow)

#### Procedure

[] (PLAY) → [MENU] → PLAY Tab → Slideshow

#### Start

Starts the slideshow.

#### Images





Specifies the type of images to be included in the slideshow

All images: Snapshots and movies

 Only: Snapshots only

 Only: Movies only

Date Setting: Images from specific dates

- Perform the following steps to specify a date.
  - ① Use [, [, [, and [] to move the red selection boundary the date you want to select, and then press [SET].  
This will select the check box of date you selected.
  - ② Repeat step ① to select all of the dates whose images you want include in the slideshow.
  - ③ After selecting all of the images you want, press [BS].
- If you save an image using any one of the following functions, the image will appear in the calendar on the date that you saved.  
Lighting, White Balance, Brightness, Resize, Trimming, Copy, MOTION PRINT
- If you edit the date and/or time of an image, the image still will appear on the date it was originally recorded.
- You can select up to 15 images for a slideshow.
- All currently selected slideshow images are deselected whenever you turn off the camera.

#### Time

Time from the start to the end of the slideshow

1 to 5 minutes, 10 minutes, 15 minutes, 30 minutes, 60 minutes



## Interval

Amount of time each image remains displayed

Use [◀] and [▶] to select a value from 1 to 30 seconds, or "MAX".

If you specify a value from 1 to 30 seconds, images change at the specified interval, but the movies will continue to play until the end.

When the slideshow reaches a movie file while "MAX" is selected, only the first frame of the movie will be displayed.

## Effect

Select the effect you want.

Pattern 1 to 4: Plays background music and applies an image change effect.

- Patterns 1 through 4 have different background music, but they all use the same image change effect.
- The currently selected image change effect setting is disabled automatically in following cases.
  - When playing a slideshow for which "📷 Only" is selected for the "Images" setting
  - When the interval setting is "MAX", 1 second or 2 seconds.
  - Before and after playback of a movie

Off: No image change effect or background music

- To stop the slideshow, press [SET]. Pressing [MENU] instead of [SET] stops the slideshow and returns to the menu screen.
- Adjust audio volume by pressing [▼] and then press [▲] or [▼] during playback.
- All button operations are disabled while the slideshow is transitioning from one image to another.
- The time required for transition from one image to another may be longer in the case of an image that was not recorded with this camera.

## **Saving Music from Your Computer to Camera Memory**

---

You can replace the built-in slideshow background music with other music from your computer.

### **Supported File Types:**

- PCM format (16-bit, monaural) WAV files
- Sampling Frequencies: 11.025 kHz/22.05 kHz/44.1 kHz

### **Number of Files: 9**

### **File names: SSBGM001.WAV to SSBGM009.WAV**

- Create the music files on your computer using the above names.
- Regardless of which effect pattern you select, the BGM files you store in camera memory are played back in name sequence.

### **1. Connect the camera to your computer (pages 122, 132).**

If you plan to save the music files to the camera's memory card, make sure the card is loaded in the camera.

---

### **2. Perform one of the following operations to open the memory card or built-in memory.**

This will cause the camera to be recognized by your computer as a Removable Disk (Drive).

- Windows
    - ① Windows 7, Windows Vista: Start → Computer
    - Windows XP: Start → My Computer
    - Windows 2000: Double-click "My Computer".
    - ② Double-click "Removable Disk".
  - Macintosh
    - ① Double-click the camera's drive icon.
- 

### **3. Create a folder named "SSBGM".**

---

### **4. Double-click the "SSBGM" folder you created and copy the background music file to it.**



- See the user documentation that comes with your computer for information about moving, copying, and deleting files.
  - If there are background music files both in built-in memory and on the memory card loaded in the camera, the files on the memory card take priority.
  - See page 138 for information about camera folders.
- 

### **5. Disconnect the camera from the computer (pages 124, 133).**



## Creating a Snapshot of Movie Frames (MOTION PRINT)

### Procedure

[] (PLAY) → Movie Screen to be Used → [MENU] → PLAY Tab → MOTION PRINT

1. Use [] and [] to scroll through the movie frames and display the one you want to use as the image of the MOTION PRINT image.

Holding down [] or [] scrolls at high speed.

2. Use [] and [] to select “Create” and then press [SET].



- Only the frames of movies recorded on this camera can be used in a MOTION PRINT image.



## Editing a Movie on the Camera (Movie Editing)



### Procedure



[] (PLAY) → Movie Screen of Movie to be Edited → [MENU] → PLAY Tab → Movie Editing

The Movie Editing feature lets you use one of the following procedures to edit out a specific part of a movie.

 Cut (To-Point Cut)	Cuts everything from the beginning of the movie up to the current location.
 Cut (Point-To-Point Cut)	Cuts everything between two points.
 Cut (From-Point Cut)	Cuts everything from the current location to the end of the movie.

1. Use [] and [] to select the editing method you want to use and then press [SET].

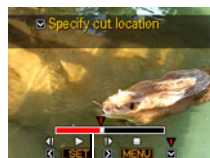

2. Use [] and [] to scroll through the movie and search for the frame (point) from which or to which you want to cut the movie (the cut point).

- You also can search for the cut location by playing back the movie and pressing [SET] to pause. During playback, you can press [] or [] to perform fast reverse or fast forward.



Cut range (red)

**3. When the frame where you want the cut point to be is displayed, press [▼].**

 <b>Cut (To-Point Cut)</b>	While the frame you want the cut to be up to is displayed, press [▼].
 <b>Cut (Point-To-Point Cut)</b>	① While the frame you want the first (From) cut to be is displayed, press [▼]. ② While the frame you want the second (To) cut to be is displayed, press [▼].
 <b>Cut (From-Point Cut)</b>	While the frame you want the cut to be from is displayed, press [▼].

**4. Use [▲] and [▼] to select “Yes” and then press [SET].**

The selected cut operation will take considerable time to complete. Don't try to perform any camera operation until the “Busy... Please wait...” message disappears from the monitor screen. Note that a cut operation can take a long time if the movie being edited is long.

 **IMPORTANT!**

- When you edit a movie, only the result is saved. The original movie is not retained. An editing operation cannot be undone.

**NOTE**

- A movie that is shorter than five seconds cannot be edited.
- Editing of movies recorded with a different type of camera is not supported.
- You will not be able to edit a movie if the amount of remaining memory capacity is less than the size of the movie file you want to edit. If there is not enough memory available, delete files you no longer need to free up more.
- Splitting of a movie into two movies and splicing of two different movies into a single movie are not supported.
- You also can start a movie editing operation while the movie you want to edit is playing back. Press [SET] to pause playback, and then press [▼] to display the menu of editing options. Perform editing using the same procedures as described above. Note, however, that you cannot edit a movie that is paused in the MAP mode.

## Optimizing Image Brightness (Lighting)

### Procedure

[] (PLAY) → Snapshot Screen → [MENU] → PLAY Tab → Lighting

You can use this setting to optimize the balance between bright areas and dark areas in existing images.

+2	Performs a higher level of brightness correction than the “+1” setting.
+1	Performs brightness correction.
Cancel	Does not perform brightness correction.

### NOTE







- Correcting the lighting when shooting produces better results (page 71).
- Altering the lighting of an image causes the original image and the new (altered) version to be stored as separate files.
- When you display an altered image on the camera's monitor screen, the date and time indicates when the image was originally recorded, not when the image was altered.

## Adjusting White Balance (White Balance)

### Procedure

[] (PLAY) → Snapshot Screen → [MENU] → PLAY Tab → White Balance

You can use the white balance setting to select a light source type for a recorded image, which will affect the colors of the image.

 Daylight	Outdoors, fair weather
 Overcast	Outdoors, cloudy to rain, in tree shade, etc.
 Shade	Very high temperature light, such as building shade, etc.
 Day White Fluorescent	White or daywhite fluorescent lighting, without suppressing color cast
 Daylight Fluorescent	Daylight fluorescent lighting, while suppressing color cast
 Tungsten	Suppressing of the appearance of light bulb lighting
Cancel	No white balance adjustment

## NOTE

- You also can adjust the white balance when recording images (page 69).
- The original snapshot is retained in memory and not deleted.
- When you display an altered image on the camera's monitor screen, the date and time indicates when the image was originally recorded, not when the image was altered.

## Adjusting the Brightness of an Existing Snapshot (Brightness)

### Procedure

**[▶] (PLAY) → Snapshot Screen → [MENU] → PLAY Tab → Brightness**

You can select one of five brightness levels, from +2 (brightest) to -2 (least bright).

## NOTE

- The original snapshot is retained in memory and not deleted.
- When you display an altered image on the camera's monitor screen, the date and time indicates when the image was originally recorded, not when the image was altered.

## Selecting Images for Printing (DPOF Printing)

### Procedure



**[▶] (PLAY) → Snapshot Screen → [MENU] → PLAY Tab → DPOF Printing**

See page 117 for details.

## Protecting a File Against Deletion (Protect)

### Procedure

[▶] (PLAY) → [MENU] → PLAY Tab → Protect

<b>On</b>	<p>Protects specific files.</p> <ol style="list-style-type: none"><li>① Use [◀] and [▶] to scroll through the files until the one you want to protect is displayed.</li><li>② Use [▲] and [▼] to select "On" and then press [SET]. An image that is protected is indicated by the  icon.</li><li>③ To protect other files, repeat steps 1 and 2. To exit the protect operation, press [MENU]. To unprotect a file, select "Off" instead of "On" in step 2 above.</li></ol>	
<b>All Files: On</b>	<p>Protects all files.</p> <ol style="list-style-type: none"><li>① Use [▲] and [▼] to select "All Files: On" and then press [SET].</li><li>② Press [MENU]. To unprotect all files, select "All Files: Off" instead of "All Files: On" in step 1 above.</li></ol>	



### IMPORTANT!

- Note that even if a file is protected, it will be deleted if you perform the format operation (page 151).

## Editing the Date and Time of an Image (Date/Time)

### Procedure

[] (PLAY) → Snapshot Screen → [MENU] → PLAY Tab → Date/Time

[▲] [▼]	Changes the setting at the cursor location
[◀] [▶]	Moves the cursor between settings
[BS]	Toggles between 12-hour and 24-hour format

When the date and time settings are what you want, press [SET] to apply them.

### NOTE

- The date and time stamped into an image using the Time Stamp (page 145) cannot be edited.
- You cannot edit the date and time of an image that is protected.
- You can input any date from 1980 to 2049.

## Deleting Location Information from an Image (Delete Site Info)

### Procedure

[] (PLAY) → Snapshot or Movie Screen → [MENU] → PLAY Tab → Delete Site Info

See page 109 for details.



## Rotating an Image (Rotation)

### Procedure

[] (PLAY) → Snapshot or Movie Screen → [MENU] → PLAY Tab → Rotation

**1. Use [] and [] to select “Rotation” and then press [SET].**

Each press of [SET] will rotate the displayed image 90 degrees left.

**2. When the displayed image is at the orientation you want, press [MENU].**

### NOTE

- Note that this procedure does not actually change the image data. It simply alters how the image is displayed on the camera's monitor screen.
- An image that has been protected or zoomed cannot be rotated.
- The original (unrotated) version of the image will be displayed on the image menu screen and the calendar screen.

## Resizing a Snapshot (Resize)

### Procedure

[] (PLAY) → Snapshot Screen → [MENU] → PLAY Tab → Resize

You can reduce the size of a snapshot and save the result as a separate snapshot. The original snapshot is also retained. You can select resize an image to one of three image sizes: 10M, 6M, VGA.





- Resizing a 3:2 or 16:9 size snapshot will create an image with an aspect ratio of 4:3, with both sides cut off.
- The recording date of the resized version of the snapshot will be the same as the recording date of the original snapshot.

## Cropping a Snapshot (Trimming)

### Procedure

[] (PLAY) → Snapshot Screen → [MENU] → PLAY Tab → Trimming

You can crop a snapshot to trim parts you do not need, and save the result in a separate file. The original snapshot is also retained.

Use the zoom controller to zoom the image to the size you want, use [, [, [, and [] to display the portion of the image you want to cut out, and then press [SET].

- The image produced by cropping a 3:2 or 16:9 image will have an aspect ratio of 4:3.
- The recording date of the cropped image will be the same as the recording date of the original snapshot.

Zoom factor

Represents  
snapshot area







Part of snapshot that is  
currently displayed

## Copying Files (Copy)

### Procedure

[] (PLAY) → Snapshot Screen → [MENU] → PLAY Tab → Copy

Files can be copied from the camera's built-in memory to a memory card or from a memory card to built-in memory.

<b>Built-in → Card</b>	Copies all files from built-in camera memory to a memory card. This option copies all the files in built-in camera memory. It cannot be used to copy a single file.
<b>Card → Built-in</b>	Copies a single file on the memory card to camera built-in camera memory. Files are copied to the folder in built-in memory whose name has the largest serial number. ① Use [  ] and [  ] to select the file you want to copy. ② Use [  ] and [  ] to select "Copy" and then press [SET].

### NOTE

- You can copy snapshots or movies you recorded with this camera.
- When a copied image appears on the full-month calendar screen, it is displayed on the date that it was copied (page 76).

## Using the Hybrid-GPS

In addition to conventional Global Positioning System (GPS) system capabilities that determine your current location and time based on radio waves it picks up from GPS satellites, your EXILIM camera also features a built-in independent motion sensor employing autonomous positioning technology that uses a 3-axis bearing sensor and a 3-axis accelerometer. These two capabilities combine to create a Hybrid-GPS that provides position information (latitude and longitude), even indoors, underground, and in areas where GPS satellite waves cannot be received.

The Hybrid-GPS supports all of the following capabilities.



- Recording current location information (latitude, longitude, camera aiming direction) with image data (snapshots and movies)
- Recording current location name with image data (snapshots and movies)
- Direct stamping of the recording location name in an image (snapshots)
- Display of recorded images and location on a map
- When traveling, searching for photogenic spots near your current location
- Tracking your movements on a map
- Automatic updating of the camera's clock based on GPS satellite wave data

A Global Positioning System (GPS) uses radio waves sent from GPS satellites orbiting the Earth to calculate positions anywhere on the globe. Signals from GPS satellites can be used to determine a person's current location and the current time at that location.

## Recording Current Location Information (Latitude, Longitude, Direction, Place Name) with Image Data

### Enabling the GPS Function (GPS)

Before using the Hybrid-GPS function for the first time, perform in the following steps to turn it on and receive GPS satellite waves.

1. Take the camera outside to a location where there is an unobstructed path to the sky above.
2. Press [ON/OFF] (Power) to turn on the camera and then press [MENU].
3. On the “Set Up” tab, select “GPS” and then press [▶].
4. Use [▲] and [▼] to select “On” and then press [SET].
5. Wait until the GPS wave condition icon (page 93) changes to ,  (GPS satellite waves being received).



#### IMPORTANT!

- When “On” is selected for the “GPS” setting, the camera’s GPS function continues to operate and periodically perform positioning, even when the camera is turned off. Whenever you are instructed to turn off all digital devices, such as during aircraft takeoffs and landings, be sure to change the camera’s “GPS” setting to “Off” and then turn off the camera.

#### NOTE

- The first GPS satellite receive operation may take more time than normal.
- When “On” is selected for the “GPS” setting, the camera will continually acquire position data (latitude, longitude) while turned on, and intermittently acquire position data while turned off.

## Recording Location Information with Image Data (Record Lat/Long)

While “On” is selected for the “Record Lat/Long” setting, location information (latitude, longitude, camera aiming direction) as measured by the Hybrid-GPS will be recorded along with the image data (snapshots and movies).





1. In the REC mode, press [MENU].
2. On the “Set Up” tab, select “Record Lat/Long” and then press [▶].
3. Use [▲] and [▼] to select “On” and then press [SET].
4. Press the shutter button (if you are shooting a snapshot) or [●] (Movie) (if you are shooting a movie).

This will record the image along with the location information (latitude, longitude, direction) for your current location.

- In the case of a snapshot, the location information is recorded when you press the shutter button all the way down. For a movie, the location information is recorded when you press [●] (Movie).

### ■ Checking GPS Wave Conditions

An icon on the display shows current GPS wave conditions. Be sure to check this icon before recording an image.

Icon	GPS Wave Conditions
	GPS satellite waves being received. GPS measurement location information can be recorded with image data.
	GPS satellite wave reception is poor, so GPS measurement location information cannot be recorded with image data. In this case, motion sensor location information will be recorded with image data.
	GPS satellite waves cannot reach your location, so GPS position information cannot be recorded with an image. The camera can, however, save position information produced by the motion sensor.
	GPS is turned off (page 92).

## NOTE

- You can delete recorded latitude, longitude, and direction data as required (page 109).
- Recorded latitude, longitude, and direction data cannot be edited.
- Shooting an image while on the move may result in incorrect position information being registered with the image.
- The current “Record Lat/Long” setting is ignored while “Off” is selected for the “GPS” setting (page 92).
- Note that location information recording is turned on under initial factory default settings. If you do not want latitude, longitude, and direction data recorded with image data, be sure to change the “Record Lat/Long” setting to “Off”.
- Location information is recorded along with any snapshots and movies you shoot while “On” is selected for “Record Lat/Long”. Remember that when you hand such image data over to another person or publish it on the Internet or via any other electronic means, the location information is included with the image data you hand over or publish. If you do not want location information made public with your image, use the “Delete Site Info” command (page 109) to delete it from the image, or do not record location information when you shoot the original snapshot or movie.

## Inserting the Place Name into Image Data (Insert Place)

You can select from among approximately 1 million place names (country names, landmark names) in camera memory and insert one into your image data (snapshots and movies).

### 1. In the REC mode, point the camera at the subject.

Based on the measurement of your current location (latitude and longitude), the camera will display a candidate place name (country name, landmark name).



Place name display

### 2. Use [◀] and [▶] to select the place name you want to insert into the image data.

- There can be up to six candidates for a place name.
- No place name will be inserted when “— —” (blank) is displayed for the place name.
- If you select “— —” (blank), the place name candidate display will disappear from the display after about two seconds. Pressing [◀] or [▶] at this time will cause the place name candidate display to reappear.
- If a place name is too long to fit on the display, it will scroll on the display.

### 3. Press the shutter button (if you are shooting a snapshot) or [●] (Movie) (if you are shooting a movie).

This will record the image along with the place name.

## ■ About place names

- Place name candidates are those selected from among the country and landmark names in camera memory based upon current latitude and longitude measurements.
- “— — —” will be shown in place of the candidates if there is no appropriate place name at your current latitude and longitude.
- Note that displayed place names are not precise and are meant as general suggestions only. Certain conditions may result in the suggestion of incorrect place name candidates.
- Some landmark names may not match the proper formal name of a landmark.
- There is no guarantee that a place name desired by you is included in the names included in camera memory.
- Shooting an image while on the move may result in incorrect place names being displayed as candidates.
- Insertion of a place name is not supported while “Off” is selected for the “GPS” setting (page 92).

---

### NOTE

- You can delete inserted place name data from images as required (page 109).
- Inserted place name data cannot be edited (page 94).

## Stamping the Place Name into an Image (Stamp Place)

---

You can use this procedure to select from among the place names (country names, landmark names) in camera memory and stamp a place directly into the image (snapshots).



### IMPORTANT!

- Unlike place name insertion, once a place name is stamped into a snapshot, it cannot be edited or deleted.

**1. In the REC mode, press [MENU].**

---

**2. On the “Set Up” tab, select “Stamp Place” and then press [▶].**

---

**3. Use [▲] and [▼] to select “On” and then press [SET].**

---

**4. Point the camera at the subject and then use the same procedure as that under “Inserting the Place Name into Image Data (Insert Place)” (page 94) to select a place name.**

---

**5. Press the shutter button to shoot.**

This will record the image with the place name stamped in it.

### NOTE

---

- Place name stamping is disabled when certain BEST SHOT scenes are being used.
- Shooting an image while on the move may result in the incorrect place name being stamped into the image.
- Insertion of a place name is not supported while “Off” is selected for the “GPS” setting (page 92).



## Precautions when Using the Hybrid-GPS

- Better GPS satellite wave reception can be attained by holding the camera still with the GPS antenna pointed towards the sky.
- Since GPS satellites are constantly moving, your location, the time of day, and other conditions may cause it to take some time before positioning can be performed. In some cases, positioning may not be possible.
- Good reception is not possible in the locations listed below due to blockage or reflection of GPS satellite waves. For good wave reception, move outside where there is an unobstructed path to the sky above.
  - Inside of a building or underground
  - Among high-rise buildings
  - Under an overhead structure
  - Inside of a tunnel
  - Near high-voltage wires
  - Inside of dense foliage
- When carrying the camera around, do not place it into a metal case. A metal enclosure makes it impossible for the camera to receive GPS satellite waves.
- Nearby magnetic and metal can cause sensor errors. Keep the camera as far away as possible from magnets and metal.
- Nearby mobile phones and other devices that use the 1.5GHz band radio waves can interfere with the camera's GPS satellite wave reception.
- Depending on wave conditions, GPS satellite positioning is subject to error of hundreds of meters.
- When you are in a location where the camera is unable to receive GPS satellite waves, positioning accuracy may be relatively lower than in locations where waves can be received.
- Reception may take a number of minutes the first time you perform GPS satellite wave reception after purchasing the camera, after the camera was continually in an area where satellite wave reception was impossible for a long time, or after leaving the camera without a battery loaded for a long time.

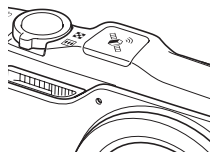

- The Hybrid-GPS is able to provide position information (latitude and longitude) even under conditions where waves cannot be received from GPS satellites. However, relying solely on the motion sensor for long periods where GPS satellite reception conditions are poor, under an underpass or on a steel bridge, or in the vicinity of buildings, pedestrian bridges, electrical equipment, steel desks, steel chairs, or other objects that generate magnetism can result in bearing, latitude, and longitude reading errors. In order to ensure that position information is as accurate as possible, it is recommended that you occasionally move to an area where there is an unobstructed path to the sky above to perform GPS satellite wave reception. The motion sensor uses GPS satellite wave reception data to calibrate its own data.
- The direction sensor may not be able to perform direction measurements under any of the following conditions.
  - Immediately after “On” is selected for the “GPS” setting (page 92)
  - Immediately after loading the battery and turning on the camera
- Do not operate the GPS function while operating a motor vehicle.
- The GPS function of this camera uses WGS84 (World Geodetic System 1984).

## Using the Map Data Stored in Camera Memory (MAP Mode)

After you press [🌐] (MAP) to enter the MAP mode, you can view the map data stored in memory and use it to perform a variety of operations described in this section.

### About the MAP mode

The MAP mode has two submodes described below. Each press of [🌐] (MAP) toggles between the two submodes. Select the submode that suits your shooting needs.

<b>User Image Mode</b>	<p>In this mode, you can display images you shot, the locations where you shot them, and the direction the camera was pointed when you shot them on a map screen.</p> <ul style="list-style-type: none"><li>• Images that include position information, the locations where you shot them, and the horizontal direction the camera was pointed when you shot them are displayed on map screens stored in camera memory.</li></ul> <p>You also can display tracks on the map that show your movements.</p> <ul style="list-style-type: none"><li>• You can use measurement data stored in camera memory to display tracks of your movements on maps stored in camera memory.</li></ul>
<b>Photogenic Spot Mode</b>	<p>This mode lets you use the on-screen map to find the locations of tourist attractions, picturesque scenery, and other photogenic spots around the world.</p> <ul style="list-style-type: none"><li>• The camera's memory contains data on a total of approximately 10,000 tourist attractions, picturesque scenery, and other photogenic spots around the world. This makes it possible for you to easily locate nearby once-in-a-lifetime photo opportunities, making your travels more exciting and rewarding.</li></ul>

- If you want to display images only, use the PLAY mode (page 30).

### ■ User Image Mode

The User Image Mode screen shows images that you shot on the map screen, along with icons and numbers that provide a wealth of information.



- 1 Zoom bar**  
Shows the current scale/position and scale/position range of the currently displayed map.
- 2 Mode icon**  
Indicates the current mode (REC, PLAY, User Image, Photogenic Spot).
- 3 Orientation icon**  
Indicates the current map orientation (north).
- 4 Current time**  
Indicates the current time.
  - The format (24-hour format or 12-hour format) of the time is in accordance with the current "Adjust" Setting.
- 5 Image cursor**  
The cursor is a frame around a user image that indicates which image is currently selected.
  - The user image mark for the image that is selected with the cursor will flash on the map.
- 6 Image list**  
Lists the images (user images) that were recorded on the currently displayed map.
  - The user image list shows images in the sequence starting from the user image mark that is closest to the center of the radar screen, and then radiates outwards in a clockwise direction.
- 7 Distance**  
Indicates the straight-line distance from the center of the radar screen to the currently flashing user image mark.
- 8 Current location icon**  
📍 indicates your current location.
  - The color of the figure indicates the current GPS positioning condition (green indicating GPS positioning, gray for non-GPS positioning).
- 9 Place name**  
Shows the place name registered along with a shot image (user image).
  - If there is not enough space to show the entire name, it will scroll on the display.
- 10 Scale**  
Shows the scale of the map.
- 11 Position information log**  
You can display the position information log to track your movements over time.
- 12 Radar screen lines**  
A cross in the center and concentric circles radiating outwards on the map provide references for distance and locations.

- 13 User image mark  
Locations where you shot images are indicated by  marks.
- User image marks are normally blue. However, user image marks outside of the radar screen lines are light blue.
  - A white wedge within a user image mark indicates the horizontal direction the camera was pointing when the image was shot. Wedge positions can be indicated in 22.5 degree units.

- 14 GPS wave condition icon  
Indicates current GPS satellite wave receipt conditions (page 92).



## ■ Photogenic Spot Mode

This mode displays recommended photogenic spots on the map, along with icons, values, and other useful information.

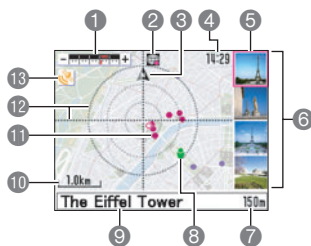
- The icons and values for which there is no explanation below are the same as those on the User Image mode screen.



- 1 Zoom bar  
2 Mode icon  
3 Orientation icon  
4 Current time  
5 Image cursor  
6 Image list  
Lists images of recommended photogenic spots currently on the map.
- The photogenic spot image list shows images in the sequence starting from the photogenic spot mark that is closest to the center of the radar screen, and then radiates outwards in a clockwise direction.



- 7 Distance  
8 Current location icon  
 indicates your current location.
- The color of the figure indicates the current GPS positioning condition (green indicating GPS positioning, gray for non-GPS positioning).
- 9 Photogenic spot name  
Shows the name of a recommended photogenic spot.
- If there is not enough space to show the entire name, it will scroll on the display.
- 10 Scale  
11 Photogenic spot mark  
Recommended photogenic spots are indicated on the map by .
- Photogenic spot marks are normally red. However, photogenic spot marks outside of the radar screen lines are purple.
- 12 Radar screen lines  
13 GPS wave condition icon

## MAP Mode Operation

### 1. Press [🌐] (MAP) to enter the MAP mode.

- Each press of [🌐] (MAP) toggles between the User Image mode and the Photogenic Spot mode.

### 2. Use the procedures below to move a user image mark or a photogenic spot mark near the center of the display's radar screen lines.

<b>To scroll the map</b>	<p>Use [▲], [▼], [◀], and [▶].</p> <ul style="list-style-type: none"><li>• To return your current location to the center of the screen, press [📍] (Current Location). This will cause 📍 (current location) to appear in the center of the radar screen.</li><li>• [📍] (Current Location) is disabled while "Off" is selected for the "GPS" setting (page 92).</li></ul>
<b>To change the scale of the map</b>	<p>Slide the zoom controller.</p> <p> (Wide Angle): Zooms out (reduces the scale) so a wider area of the map is visible.</p> <p> (Telephoto): Zooms in (increases the scale) so a smaller area of the map is visible.</p> <div data-bbox="731 518 917 649"></div> <p data-bbox="737 656 888 678">Zoom controller</p>

- Moving a user image mark or photogenic spot mark to the center of the radar screen causes the corresponding image (user image or photogenic spot image) to move to the top of the image list to the right of the map.
- The images that appear in the list on the screen are displayed in sequence starting from the landmark that is closest to the center of the radar screen and then radiating outwards in a clockwise direction.

---

### 3. Press [SET].

This will display a full-screen view of the image (user image or photogenic spot image) where the image cursor was located in the image list.

- While a full-screen image is displayed, you can use [◀] (scrolls to the image that was above the current image in the image list) and [▶] (scrolls to the image that was below the current image in the image list) to scroll to another image.
- Sliding the zoom controller towards [🔍] (🔍) will zoom in on and enlarge the image (page 75).
- Sliding the zoom controller towards [🖼️] (🖼️) will display a multi-image screen containing the images that were in the image list (page 75).

---

### 4. Press [▲] (DISP) (page 152).

This will display the following information.

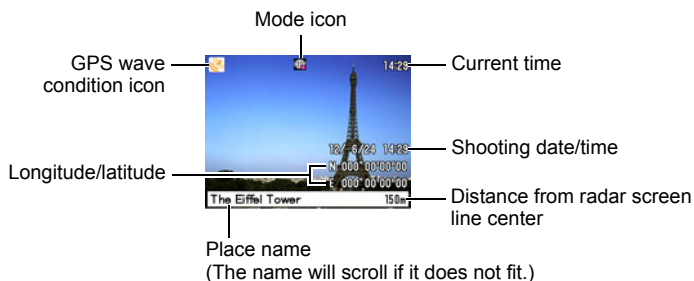

## IMPORTANT!

- If a section of the zoom bar is gray while a map is displayed, it indicates that the camera does not have further detailed map data for the gray section. In this case, if you slide the zoom controller towards [📷] (Telephoto) and the zoom pointer reaches a gray section, the pointer will stop and the map will not zoom in any further.
- A gray rectangular frame on a map indicates that there is detailed map data available for that area in camera memory. Sliding the zoom controller towards [📷] (Telephoto) while such a gray frame is in the center of the radar screen will display the detailed (higher scale) map data.
- When scrolling the map, the message “No Image” will appear in an area where there is no more map data available in camera memory.
- If you move an area for which there is no map data available to the center of the radar screen, the map will change automatically to a scale for which map data is available.
- To find your current location on the map, press [📍] (Current Location). This will cause the 📍 (current location) icon to appear in the center of the radar screen.

Gray area indicates more detailed map data not available.

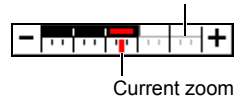

## Basic MAP Mode Settings

### ■ Enabling Movement of the Image Cursor (Move Cursor)

Use this procedure to enable movement of the image cursor inside the image list next to a map.

1. In the MAP mode, press [MENU].
2. On the “MAP” tab, select “Move Cursor” and then press [▶].
3. Use [▲] and [▼] to select the setting you want and then press [SET].

<b>On</b>	Enables image cursor movement. Holding down [BS] and tilting the camera approximately 20 degrees away from you will move the cursor upwards. Tilting the camera towards you will move the cursor downwards.	A line drawing of a hand holding a camera. An arrow indicates the camera being tilted upwards. A circular inset shows a close-up of the camera's controls, with a button labeled 'BS' circled.
<b>Off</b>	Disables image cursor movement.	



## Using Other Map Data (MAP Tab Menu)

This section explains the menu items that are used when performing operations and configuring settings in the MAP mode.

For information about menu operations, see page 58.

### Saving Position Information (Save Log)

#### Procedure

[Globe] (MAP) → [MENU] → MAP Tab → Save Log

You can use this procedure to save position information from different locations and different times. While “On” is selected for the “Save Log” setting, the following information is saved in camera memory for 14 days as positioning log data.

- Date (year, month, day) and time (hour, minute)
- Latitude and longitude
- Altitude (When GPS positioning is performed.)
- Positioning method and positioning accuracy
- The current “Save Log” setting is ignored while “Off” is selected for the “GPS” setting (page 92).



#### IMPORTANT!

- Note that in China it is against the law to accumulate a log of position information without the permission of government authorities. Be sure to select “Off” for the “Save Log” setting if you are using the camera in China and do not have such permission.

### Tracking Your Movements on a Map (Show Log)

#### Procedure

[Globe] (MAP) → [MENU] → MAP Tab → Show Log

You can track your movements by displaying positioning log data on a map. Selecting “On” for the “Show Log” setting causes saved positioning log data to be displayed on the map.

## Specifying the Display Period of Tracks (Log Period)

---

### Procedure

[] (MAP) → [MENU] → MAP Tab → Log Period

This setting lets you specify how many past days of track data should be displayed on map.

## Enabling Movement of the Image Cursor (Move Cursor)

---

### Procedure

[] (MAP) → [MENU] → MAP Tab → Move Cursor

See page 104 for details.

## Adjusting the Accuracy of the Direction Sensor (Direction Adj)

---

The camera's built-in direction sensor may not operate normally if there is a source of magnetism nearby. If you feel that direction measurements are not correct, perform the following procedure.

**1. Turn on the camera and then press [] (MAP).**

---

**2. Press [MENU]. On the “MAP” tab, select “Direction Adj”.**

---

**3. Taking care not to drop the camera, slowly swing it around in a figure eight for about 10 seconds.**

Use the wrist of the hand that is holding the camera to move in a way that forms a figure eight. This will correct for the magnetism and adjust direction sensor accuracy.

The message “Completed normally.” will appear to let you know that accuracy adjustment is complete, and the map screen will return to the display.

- If the message “Correction failed. Try again.” appears, perform the above procedure again.
- Performing this adjustment near a train, an automobile, a magnet, or a concentration of metal can result in incorrect adjustment.
- Direction sensor adjustment is not supported while “Off” is selected for the “GPS” setting (page 92).

## Converting Location Information of Images from Another Source for Playback on This Camera (Update Info)

---

You can use this procedure to convert position information (latitude and longitude) accompanying an image recorded on another manufacturer's camera so it can be played back in the MAP mode of this camera.

- 1. Use the Photo Transport that comes with the camera to copy the other manufacturer's image with position information from your computer to a memory card (page 129).**

---
- 2. Turn off the camera and load the memory card that contains the data.**

---
- 3. Turn on the camera and then press [Globe] (MAP).**

---
- 4. Press [MENU]. On the "MAP" tab, select "Update Info" and then press [▶].**

---
- 5. Use [▲] and [▼] to select "Update" and then press [SET].**

The message "Busy... Please wait..." will appear as the data is being transferred. After that, the image with position data will be displayable in the MAP mode.



### **IMPORTANT!**

- The position information of certain types of images may not be able to be updated.

## Other Settings (Set Up Tab Menu)

For information about menu operations, see page 58.

For information about other settings, see page 140.

### Auto Image Orientation Detection and Rotation (Auto Rotate)

#### Procedure

[MENU] → Set Up Tab → Auto Rotate

<b>On</b>	Automatically rotates snapshots shot with the camera held vertically 90 degrees.
<b>Off</b>	Images not rotated automatically.

The camera automatically detects whether a snapshot image was shot in portrait or landscape orientation and displays it accordingly.

- The current “Auto Rotate” setting is ignored while “Off” is selected for the “GPS” setting (page 92).

### Correcting Camera Clock Settings Automatically (Time Auto Correct)

#### Procedure

[MENU] → Set Up Tab → Time Auto Correct

While “On” is selected for the “Time Auto Correct” setting, the camera uses time data received from GPS satellites to automatically correct its clock settings.



#### IMPORTANT!

- Note that switching between summer time and standard time is not performed automatically.
- World Time settings (for all 32 time zones) are corrected when a wave is received from the GPS satellites. Note, however, that in this case the displayed time will not change until you turn the camera off and then back on again. If you travel to another time zone, you can find out the current local time by turning the camera off and then back on again, and checking the displayed time.
- Attempting to change “World Time” setting (page 144) or the “Adjust” setting (page 146) while “On” is selected for the “Time Auto Correct” setting, will cause the message “Auto time correction is turned on. Cannot perform operation.” to appear on the display.
- The World Time City and time settings may not update correctly when you are located in the vicinity of a boundary between two time zones. If this happens, select “Off” for the “Time Auto Correct” setting, and then use “World Time” setting (page 144) or the “Adjust” setting (page 146) to adjust the time and date settings.
- The current “Time Auto Correct” setting is ignored while “Off” is selected for the “GPS” setting (page 92).

## Displaying Images with Location Information (PLAY Mode)

As with normal images (without location information), use the PLAY mode to display images with location information.

### Viewing an Image with Location Information

See page 30 for the procedure for viewing images.

- While an image with location information is on the display, pressing [▲] (DISP) will display the location information (latitude and longitude) that was recorded with the image.



#### IMPORTANT!

- In the PLAY mode, you cannot display the map where the image was recorded while the image is displayed.

Latitude and longitude

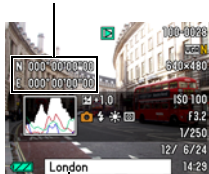

Place name  
(Name scrolls if it is too long to fit.)

### Clearing Location Information Included with an Image (Delete Site Info)

Use this procedure when you want to clear the location information (latitude, longitude, direction, place name) recorded with an image.



#### IMPORTANT!

- Remember that a location information delete operation cannot be undone.

- In the PLAY mode, use [◀] and [▶] to select the image whose location information you want to clear.
- Press [MENU]. On the “PLAY” tab, select “Delete Site Info” and then press [▶].
- Use [▲] and [▼] to specify what you want to clear and then press [SET].

Delete Lat/Long	Deletes the latitude, longitude, and direction recorded with the image.
Delete place	Deletes the place name recorded with the image.
Cancel	Cancels the operation without deleting anything.

### ■ Using the camera in another country

- Certain countries or areas may place restrictions on the use of GPS and/or the accumulation of positioning log data. This camera has a built-in GPS function. Before taking it to another country, be sure to check with the appropriate embassy or with your travel agent to find out if bringing in a camera with a GPS function and/or accumulation of position information log data is allowed in that country.
- Recommended photogenic spots are provided for reference only, and there is no guarantee that you will be able to get to a site or that it will be simple to get to a site. Before entering a mountainous, jungle, desert, or other dangerous area or any area where your personal safety may be at risk, be sure to obtain the latest news about regulations, restrictions, safety, and other important information.

### ■ Hybrid-GPS operation while the camera is turned off

- When “On” is selected for the “GPS” setting, the Hybrid-GPS continues to operate and periodically performs positioning to determine your current location, even when the camera is turned off. Whenever you need to completely turn off the camera and disable positioning (such as during aircraft takeoffs and landings), be sure to change the “GPS” setting to “Off” (page 92) and then turn off the camera.
- Also note that battery power continues to be consumed if the camera is turned off while “On” is selected for the “GPS” setting.

### ■ Not using the camera for a long time

- For the first GPS wave reception after you have not used the camera for a long time or after leaving the camera without the battery loaded for a long time, positioning will take longer than normal to complete.

### ■ Immediate position correction

- Because camera’s autonomous positioning uses an accelerometer and a direction sensor for positioning, the Hybrid-GPS function can become unstable where there is severe magnetic disturbance (on a train, in a motor vehicle), or where there is severe movements (inside of a bag, etc.). Whenever the camera judges that autonomous positioning is unstable, it performs immediate GPS wave reception and corrects positioning.

# Dynamic Photo

This camera comes with a number of subjects in built-in memory ("built-in subjects"), which you can insert into snapshots and movies to create Dynamic Photo images.

- The term "built-in subjects" refers to the moving figures and characters that came pre-programmed in the camera's built-in memory.



## Inserting a Built-in Subject into a Snapshot or Movie (Dynamic Photo)

Use the following procedure to insert a built-in subject image into a snapshot or movie.

### Procedure

[] (PLAY) → [MENU] → PLAY Tab → Dynamic Photo

**1. Use [] and [] to select the background image you want and then press [SET].**

- Only an image that satisfies the following conditions can be used as a background image.
  - A snapshot or movie recorded with this camera or a snapshot transferred to this camera's memory using Photo Transport (page 128)
  - A snapshot with an aspect ratio of 4:3

**2. Use [] and [] to select the built-in subject that you want to insert into the image and then press [SET].**

---

**3. If you are inserting a subject into a movie an image will appear on the monitor screen showing the approximate location of the subject in the movie. Use [◀] and [▶] to shift the location to the position you want. After you are finished, press [SET].**

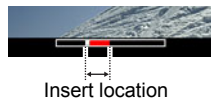

- If you insert a subject into a movie, the resulting movie will be a maximum of 20 seconds long. Everything before and after the insertion is cut off. If the movie you are inserting into (original movie) is shorter than 20 seconds, the resulting movie will be the same length as the original movie.
- If you are inserting a subject into a snapshot, skip directly to step 4.

---

**4. Use the zoom controller to adjust the size of the subject and use [▲], [▼], [◀], and [▶] to adjust its position.**

---

**5. When everything is the way you want, press [SET].**

This inserts the subject into another image and creates a Dynamic Photo.

- Inserting an animated subject into a snapshot will save a Dynamic Photo that consists of 20 still images of 2M size or smaller.
- Inserting a subject into a movie will save the Dynamic Photo as a movie file.

---

**NOTE**

- Performing a delete or format operation will not delete the built-in subjects.
- You can copy the built-in subjects to a memory card using the “Built-in → Card” copy operation (page 90).



## To view a Dynamic Photo (Dynamic Photo File)

1. Press **[▶]** (PLAY) and then use **[◀]** and **[▶]** to display the Dynamic Photo you want to view.
2. If you want to see the subject in the Dynamic Photo move, press **[SET]**.  
The Dynamic Photo is repeated as a continuous loop.
  - Movement of the subject also will start automatically about two seconds after you display a Dynamic Photo.

## Converting a Dynamic Photo Still Image to a Movie (Movie Converter)

A Dynamic Photo with a still image background and a moving subject is stored as a series of 20 still images. You can use the following procedure to convert the 20 images that make up a Dynamic Photo to a movie.

### Procedure

**[▶]** (PLAY) → Dynamic Photo Screen → **[MENU]** → **PLAY Tab** → **Movie Converter**

- The final movie format is H.264.
- The final movie image size is 640×480 pixels.

## Printing Snapshots

### Professional Print Service

You can take a memory card that contains the images you want to print to a professional print service and have them printed.



### Printing on a Home Printer

#### Printing Images on a Printer with Memory Card Slot

You can use a printer equipped with a memory card slot to print images directly from a memory card. For details, see the user documentation that comes with your printer.



#### Connecting Directly to a PictBridge Compatible Printer

You can print on a printer that supports PictBridge (page 115).

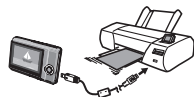

### Printing with a Computer

After transferring the images to your computer, use commercially available software to print.

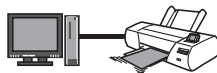

- You can specify which images you want to print, the number of copies, and date stamp settings before printing (page 117).

## Connecting Directly to a PictBridge Compatible Printer

You can connect the camera directly to a printer that supports PictBridge and print images without going through a computer.

### ■ To set up the camera before connecting to a printer

1. Turn on the camera and press [MENU].
2. On the "Set Up" tab, select "USB" and then press [▶].
3. Use [▲] and [▼] to select "PTP (PictBridge)", and then press [SET].

### ■ Connecting the Camera to a Printer

Use the USB cable that comes bundled with the camera to connect the camera to your printer's USB port.

- The camera does not draw power over the USB cable. Make sure the camera's battery is sufficiently charged before connecting.
- Make sure that you insert the cable connector into the USB/AV port until you feel it click securely into place. Failure to insert the connector fully can result in poor communication or malfunction.
- Note that even while the connector is fully inserted, you still will be able to see the metal part of the connector as shown in the illustration.
- When connecting the USB cable to a USB port, make sure you align the connector correctly with the port.

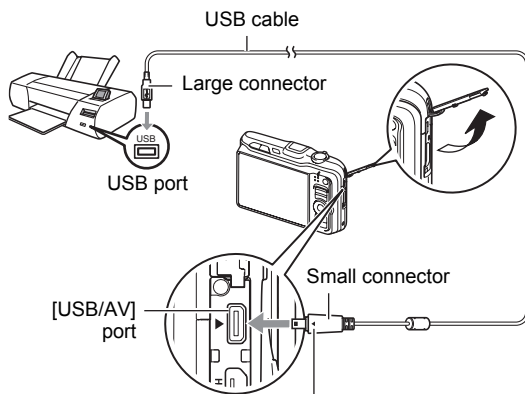

Making sure that the ▶ mark on the camera is aligned with the ◀ mark of the USB cable connector, connect the cable to the camera.

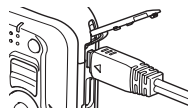

## ■ To print

### 1. Turn on the printer and load paper.

### 2. Turn on the camera.

This will display the print menu screen.

### 3. Use [▲] and [▼] to select “Paper Size”, and then press [▶].



### 4. Use [▲] and [▼] to select a paper size and then press [SET].

- The following are the available paper sizes.  
3.5"×5", 5"×7", 4"×6", A4, 8.5"×11", By Printer
- Selecting “By Printer” prints using a paper size selected on the printer.
- See the documentation that comes with your printer for information about paper settings.

### 5. Use [▲] and [▼] to specify the print option you want.

1 Image : Prints one image. Select and then press [SET]. Next, use [◀] and [▶] to select the image you want to print.

DPOF Printing : Prints multiple images. Select and then press [SET]. With this option, images will be printed in accordance with DPOF settings (page 117).

- To toggle date stamping on and off, press [BS]. The date stamp will be printed when “On” is indicated on the monitor screen.

### 6. Use [▲] and [▼] to select “Print” and then press [SET].

Printing will start and the message “Busy... Please wait...” will appear on the monitor screen. The message will disappear after a short while, even though printing is still being performed. Pressing any camera button will cause the printing status to re-appear. The print menu screen will re-appear when printing is complete.

- If you selected “1 Image”, you can repeat the procedure from step 5, if you want.



### 7. After printing is complete, turn off the camera and disconnect the USB cable from the printer and camera.

## Using DPOF to Specify Images to be Printed and the Number of Copies

### ■ Digital Print Order Format (DPOF)

DPOF is a standard that allows you to include image type, number of copy, and time stamp on/off information on the memory card with the images. After configuring settings, you can use the memory card to print on a home printer that supports DPOF or take the memory card to a professional print service.



- Whether or not you will be able to use DPOF settings for printing depends on the printer you are using.
- Some professional print services may not support DPOF.

### ■ Configuring DPOF Settings Individually for Each Image

#### Procedure

[] (PLAY) → Snapshot Screen → [MENU] → PLAY Tab → DPOF Printing → Select images

1. Use [] and [] to scroll through the files until the image you want to print is displayed.

---

2. Use [] and [] to specify the number of copies.  
You can specify a value up to 99. Specify 00 if you do not want to print the image.
  - If you want to include the date in the images, press [BS] so “On” is shown for date stamping.
  - Repeat steps 1 and 2 to configure settings for other images, if you want.

---

3. Press [SET].

## ■ Configuring the Same DPOF Settings for All the Images

### ▶ Procedure

[▶] (PLAY) → Snapshot Screen → [MENU] → PLAY Tab → DPOF Printing → All images

#### 1. Use [▲] and [▼] to specify the number of copies.

You can specify a value up to 99. Specify 00 if you do not want to print the image.

- If you want to include the date in the images, press [BS] so “On” is shown for date stamping.

---

#### 2. Press [SET].

#### **DPOF settings are not cleared automatically after printing is complete.**

The next DPOF print operation you execute will be performed using the last DPOF settings you configured for the images. To clear DPOF settings, specify “00” for the number of copies of all images.

#### **Tell your print service about your DPOF settings!**

If you take a memory card to a professional print service, be sure to tell them that it includes DPOF settings for the images to be printed and the number of copies. If you don't, the print service may print all the images without regard to your DPOF settings, or they may ignore your date stamp setting.

## ■ Date Stamping

You can use one of the following three methods to include the recording date in the printout of an image.

Configuring camera settings
Configure DPOF settings (page 117). You can turn date stamping on and off each time you print. You can configure settings so some images include the date stamp and some don't.
Configure the Camera's Time Stamp setting (page 145). <ul style="list-style-type: none"><li>• The camera's Time Stamp setting imprints the date into a snapshot when you shoot it, so the date is always included when you print. It cannot be deleted.</li><li>• Do not turn on DPOF date stamping for an image that includes a date stamped with the camera's Time Stamp function. Doing so can cause the two stamps to be overprinted.</li></ul>
Configuring computer settings
You can use commercially available image management software to date stamp images.
Professional print service
Request date stamping when ordering prints from a professional print service.

## ■ Standards Supported by the Camera





- PictBridge  
This is a standard of the Camera and Imaging Products Association (CIPA).
- PRINT Image Matching III  
Using image editing software and printing on a printer that supports PRINT Image Matching III makes it possible to use information about shooting conditions that is recorded with the image, and produce exactly the type of image you want. PRINT Image Matching and PRINT Image Matching III are trademarks of Seiko Epson Corporation.
- Exif Print  
Printing on a printer that supports Exif Print uses information about shooting conditions recorded with the image to enhance printed image quality. Contact your printer manufacturer for information about models that support Exif Print, printer upgrades, etc.



# Using the Camera with a Computer

## Things you can do using a computer...

You can perform the operations described below while the camera is connected to a computer.

<b>Save images to a computer and view them there</b> 	<ul style="list-style-type: none"><li>• Save images and view them manually (USB connection) (pages 122, 131).</li><li>• Transfer images to a computer automatically over a wireless LAN for viewing (Eye-Fi) (page 135).</li></ul>
<b>Transfer images stored on your computer to camera memory</b> 	In addition to images, you also can transfer screen shot images from your computer to the camera (Photo Transport*) (page 128).
<b>Play back and edit movies</b> 	<ul style="list-style-type: none"><li>• You can play back movies (pages 125, 134). To play back movies, use software that is compatible with your computer's operating environment.</li><li>• To edit movies, use commercially available software as required.</li></ul>
<b>View images you shot and locations where you shot them on a map</b> 	You can view images you shot that include position information and the location where you shot them on a map. (Picasa, Google Earth) (page 130)

\* Windows only

The procedures you need to perform when using the camera with your computer and when using the bundled software are different for Windows and the Macintosh.

- Windows users should refer to "Using the Camera with a Windows Computer" on page 121.
- Macintosh users should refer to "Using the Camera with a Macintosh" on page 131.



## Using the Camera with a Windows Computer

Install the required software in accordance with the version of Windows you are running and what you want to do.

When you want to do this:	Operating System Version	Install this software:	See page:
Save images to a computer and view them there manually	Windows 7, Windows Vista, Windows XP, Windows 2000	Installation not required.	122
Play movies	Windows 7	Installation not required. <ul style="list-style-type: none"> <li>Windows Media Player 12, which is already installed on most computers, can be used for playback.</li> </ul>	125
	Windows Vista, Windows XP	Movies can be played back using QuickTime 7. <ul style="list-style-type: none"> <li>You need to download QuickTime 7 on the Web if you want to use it.</li> </ul>	
Edit movies	Windows 7, Windows Vista, Windows XP, Windows 2000	– <ul style="list-style-type: none"> <li>Use commercial software as required.</li> </ul>	–
Upload movie files to YouTube	Windows 7, Windows Vista, Windows XP (SP2/SP3), Windows 2000 (SP4)	<b>YouTube Uploader for CASIO*</b>	126
Transfer images to the camera	Windows 7, Windows Vista, Windows XP, Windows 2000	<b>Photo Transport 1.0*</b>	128
Display images and locations on a map	Windows 7, Windows Vista, Windows XP	<b>Picasa</b>	130
	Windows Vista, Windows XP, Windows 2000	<b>Google Earth</b>	
View the User's Guide	Windows 7, Windows Vista, Windows XP (SP2/SP3), Windows 2000 (SP4)	<b>Adobe Reader 9</b> (Not required if already installed.)	130

\* YouTube Uploader for CASIO and Photo Transport will not run under 64-bit versions of Windows OS.

## ■ Computer System Requirements for Bundled Software

Computer system requirements are different for each of the applications. See the “Read me” file that comes with each application for details. Information about computer system requirements also can be found under “Computer System Requirements for Bundled Software (Bundled CD-ROM)” on page 165 of this manual.

## ■ Precautions for Windows Users

- Except for Adobe Reader, the bundled software requires Administrator privileges to run.
- Operation on a self-made computer is not supported.
- Operation may not be possible under certain computer environments.

## Viewing and Storing Images on a Computer

---

You can connect the camera to your computer in order to view and store images (snapshot and movie files).

### NOTE

---

- You also can use your computer’s card slot (if it has one) or a commercially available card reader to access image files directly from the camera’s memory card. For details, see the user documentation that comes with your computer.

## ■ To connect the camera to your computer and save files

1. Turn on the camera and press [MENU].
2. On the “Set Up” tab, select “USB” and then press [▶].
3. Use [▲] and [▼] to select “Mass Storage”, and then press [SET].

---

**4. Turn off the camera and then use the USB cable that comes with the camera to connect it to your computer.**

- The camera does not draw power over the USB cable. Make sure the camera's battery is sufficiently charged before connecting.
- Make sure that you insert the cable connector into the USB/AV port until you feel it click securely into place. Failure to insert the connector fully can result in poor communication or malfunction.
- Note that even while the connector is fully inserted, you still will be able to see the metal part of the connector as shown in the illustration.
- When connecting the USB cable to a USB port, make sure you align the connector correctly with the port.
- Your computer may not be able to recognize the camera if you connect via a USB hub. Always connect directly to the computer's USB port.

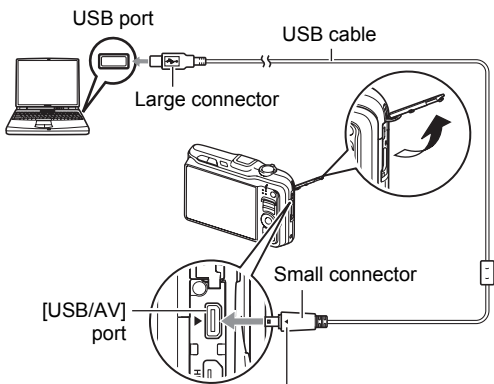

Making sure that the ▶ mark on the camera is aligned with the ◀ mark of the USB cable connector, connect the cable to the camera.

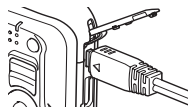

---

**5. Turn on the camera.**

---

**6. Windows 7, Windows Vista users: Click “Start” and then “Computer”.  
Windows XP users: Click “Start” and then “My Computer”.  
Windows 2000 users: Doubleclick “My Computer”.**

---

**7. Double-click “Removable Disk”.**

- Your computer recognizes the memory card loaded in the camera (or built-in memory if there is no card) as a removable disk.

---

**8. Right-click the “DCIM” folder.**

---

**9. On the shortcut menu that appears, click “Copy”.**

---

**10. Windows 7, Windows Vista users: Click “Start” and then “Documents”.  
Windows XP users: Click “Start” and then “My Documents”.**

**Windows 2000 users: Doubleclick “My Documents” to open it.**

- If you already have a “DCIM” folder in “Documents” (Windows 7, Windows Vista) or “My Documents” (Windows XP, Windows 2000), the next step will overwrite it. If you want to keep the existing “DCIM” folder, you need to change its name or move it to a different location before performing the next step.

---

**11. Windows 7 users: On the “Documents” “Organize” menu, select “Paste”.**

**Windows Vista users: On the “Documents” “Edit” menu, select “Paste”.**

**Windows XP, Windows 2000 users: On the “My Documents” “Edit” menu, select “Paste”.**

This will paste the “DCIM” folder (and all the image files it contains) into your “Documents” (Windows 7, Windows Vista) or “My Documents” (Windows XP, Windows 2000) folder. You now have a copy of the files that are in camera memory on your computer.

---

**12. After you finish copying images, disconnect the camera from the computer.**

**Windows 7, Windows Vista, Windows XP**

On the camera, press [ON/OFF] (Power) to turn off the camera. After making sure that the back lamp is unlit, disconnect the camera from the computer.

**Windows 2000**

Click card services in the task tray on your computer screen, and disable the drive number assigned to the camera. Next, after making sure that the back lamp is unlit, press the camera’s [ON/OFF] (Power) button to turn off the camera and disconnect the camera from your computer.

**■ To view images you copied to your computer**

**1. Double-click the copied “DCIM” folder to open it.**

---

**2. Double-click the folder that contains the images you want to view.**

---

### 3. Double-click the image file you want to view.

- For information about file names, see "Memory Folder Structure" on page 138.
- An image that was rotated on the camera will be displayed on your computer screen in its original (unrotated) orientation.

**Never use your computer to modify, delete, move, or rename any image files that are in the camera's built-in memory or on its memory card.**

Doing so can cause problems with the camera's image management data, which will make it impossible to play back images on the camera and can drastically alter remaining memory capacity. Whenever you want to modify, delete, move, or rename an image, do so only on images that are stored on your computer.

#### **IMPORTANT!**

- Never unplug the USB cable, or operate the camera while viewing or storing images. Doing so can cause data to become corrupted.

---

## Playing Movies

To play back a movie, first copy it to your computer and then double-click the movie file. Some operating systems may not be able to play back movies. If this happens, you need to install separately available software.

- With Windows 7, playback is supported by Windows Media Player 12.
- If you are unable to play back movies, go to the URL below to download QuickTime 7 and install it on your computer.

<http://www.apple.com/quicktime/>

### ■ Minimum Computer System Requirements for Movie Playback

The minimum system requirements described below are necessary to play back movies recorded with this camera on a computer.

Operating System : Windows 7, Windows Vista, Windows XP (SP2/SP3)

CPU : Image Quality "HD":  
Core 2 Duo 3.0GHz or higher  
Image Quality "STD":  
Pentium 4 3.2GHz or higher

Required Software: QuickTime 7 (Not required with Windows 7.)

- The above are recommended system environments. Configuring one of these environments does not guarantee proper operation.
- Certain settings and other installed software may interfere with proper playback of movies.

## ■ Movie Playback Precautions

- Be sure to move the movie data to the hard disk of your computer before trying to play it. Proper movie playback may not be possible for data accessed over a network, from a memory card, etc.
- Proper movie playback may not be possible on some computers. If you experience problems, try the following.
  - Try recording movies with a quality setting of “STD”.
  - Quit any other applications you have running, and stop resident applications.

Even if proper playback is not possible on the computer, you can use the AV cable that comes bundled with the camera to connect to the video input terminal of a TV or computer and play back movies that way.

## ■ Uploading Movie Files to YouTube

---

Installing YouTube Uploader for CASIO from the CD-ROM that comes with your camera simplifies uploading of movie files you recorded with the “For YouTube” BEST SHOT scene to YouTube.

### ■ What is YouTube?

YouTube is a movie sharing site managed by YouTube, LLC where you can upload movies and view movies uploaded by others.

### ■ To install YouTube Uploader for CASIO

- 1. On the CD-ROM menu screen, select “YouTube Uploader for CASIO”.**
- 2. After reading the information about installation conditions and system requirements for installation in the “Read me” file, install YouTube Uploader for CASIO.**

## ■ To upload a movie file to YouTube

- Before you can use YouTube Uploader for CASIO, you need to go to the YouTube website (<http://www.youtube.com/>) and register as a user there.
- Do not upload any video that is copyrighted (including neighboring copyrights) unless you yourself own the copyright or you have obtained the permission of the applicable copyright holder(s).
- A single movie shoot with the “For YouTube” scene can have a maximum file size of 2048MB or a recording time of up to 15 minutes.
- The maximum file size for each upload is 2048MB.

**1. On the BEST SHOT scene menu, select the “For YouTube” scene (page 52).**

---

**2. Press [●] (Movie) to record the movie.**

---

**3. If it isn't already, connect your computer to the Internet.**

---

**4. Connect the camera to your computer (page 122).**

---

**5. Turn on the camera.**

YouTube Uploader for CASIO will start up automatically.

- If this is the first time you are using the application, configure the YouTube user ID and network environment settings, and then click the [OK] button.
- 

**6. The left side of the display will have an area for inputting a title, category, and other information required for uploading to YouTube. Enter the required information.**

---

**7. The right side of the display shows a list of movie files in camera memory. Select the check box next to the movie file you want to upload.**

---

**8. When everything is ready, click the [Upload] button.**

This will upload the movie file(s) to YouTube.

- After uploading is complete, click the [Exit] button to exit the application.

## Transferring Images from Your Computer to Camera Memory

---

If you want to transfer images from your computer to the camera, install Photo Transport on your computer from the CD-ROM that comes with the camera.

### ■ To install Photo Transport

1. On the CD-ROM menu screen, select “Photo Transport”.

---
2. After reading the information about installation conditions and system requirements for installation in the “Read me” file, install Photo Transport.

### ■ To transfer images to the camera

1. Connect the camera to your computer (page 122).

---
2. On your computer, click the following: Start → All Programs → CASIO → Photo Transport.  
This starts up Photo Transport.

---
3. Drag the file(s) you want to transfer to the [Transfer] button.

---
4. Follow the instructions that appear on the display to complete the transfer.
    - The details of the instructions that appear on the display and the transferred images will depend on your Photo Transport setup. For details, click the [Settings] button or [Help] button and check the setup.

### Transfer Data

- Only image files with the following extensions can be transferred to the camera. jpg, jpeg, jpe, bmp (bmp images are converted to jpeg images automatically when transferred.)
- Certain types of images may not be able to be transferred.
- You cannot transfer movies to the camera.



## ■ To transfer computer screen captures to the camera

**1. Connect the camera to your computer (page 122).**

---

**2. On your computer, click the following: Start → All Programs → CASIO → Photo Transport.**

This starts up Photo Transport.

---

**3. Display the screen whose screen capture you want to transfer.**

---

**4. Click the [Capture] button.**

---

**5. Draw a boundary around the area you want to capture.**

Move your mouse pointer to the upper left corner of the area you want to capture and then hold down the mouse button. Keeping the mouse button depressed, drag the pointer down to the lower right corner of the area and then release the mouse button.

---

**6. Follow the instructions that appear on the display.**

This will send an image of the area you selected to the camera.

- The transfer operation converts screen captures to JPEG format.
- The instructions that appear on the display and details about the transferred images will depend on your Photo Transport setup. For details, click the [Settings] button or [Help] button and check the setup.

## ■ About settings and help

Click the [Settings] button when you want to change the Photo Transport setup. For help about operation procedures and troubleshooting, click the Photo Transport [Help] button.

## Viewing an Image's Recording Location

---

After you shoot an image while "On" is selected for the "Record Lat/Long" setting, you will be able to display the location where you shot it on a map.

To use this function, you need to access the CD-ROM that comes with the camera and then go to the Picasa website and install Picasa, or to the Google Earth website and install Google Earth.

For details about Picasa and Google Earth, see the HELP on the Picasa and Google Earth websites.

## Viewing User Documentation (PDF Files)

---

### 1. Start up your computer, and place the bundled CD-ROM into its CD-ROM drive.

Normally, this should cause the menu screen to appear automatically. If your computer does not display the menu screen automatically, navigate to the CD-ROM on your computer and then double-click the "AutoMenu.exe" file.

### 2. On the menu screen, click the "Language" down arrow button and then select the language you want.

### 3. Click "Manual" to select it and then click "Digital Camera".

#### **IMPORTANT!**

- You must have Adobe Reader or Adobe Acrobat Reader installed on your computer in order to view the contents of a PDF file. If you do not already have Adobe Reader or Adobe Acrobat Reader installed, install Adobe Reader from the bundled CD-ROM.

## User Registration

---

You can perform user registration over the Internet. To do so, of course, you need to be able to connect to the Internet with your computer.

### 1. On the CD-ROM menu screen, click the "Register" button.

- This starts up your Web browser and accesses the user registration website. Follow the instructions that appear on your computer screen to register.

## Using the Camera with a Macintosh

Install the required software in accordance with what version of the Macintosh OS you are running and what you want to do.

When you want to do this:	Operating System Version	Install this software:	See page:
Save images to your Macintosh and view them there manually	OS 9	Installation not required.	131
	OS X		
Save images to your Macintosh automatically/ Manage images	OS 9	Use commercially available software.	134
	OS X	Use iPhoto, which comes bundled with some Macintosh products.	
Play movies	OS 9	Playback not supported.	134
	OS X	Movie file playback is supported under OS X 10.4.11 or higher when QuickTime 7 or higher is installed.	

### Connecting the Camera to Your Computer and Saving Files



#### IMPORTANT!

- The camera does not support operation with Mac OS 8.6 or earlier, or Mac OS X 10.0. Operation is supported with Mac OS 9, X (10.1, 10.2, 10.3, 10.4, 10.5, 10.6) only. Use the standard USB driver that comes with your supported operating system.

#### NOTE

- You also can use your computer's card slot (if it has one) or a commercially available card reader to access image files directly from the camera's memory card. For details, see the user documentation that comes with your computer.

## ■ To connect the camera to your computer and save files

1. Turn on the camera and press [MENU].

2. On the “Set Up” tab, select “USB” and then press [▶].

3. Use [▲] and [▼] to select “Mass Storage”, and then press [SET].

4. Turn off the camera and then use the USB cable that comes with the camera to connect it to your Macintosh.

- The camera does not draw power over the USB cable. Make sure the camera's battery is sufficiently charged before connecting.
- Make sure that you insert the cable connector into the USB/AV port until you feel it click securely into place. Failure to insert the connector fully can result in poor communication or malfunction.
- Note that even while the connector is fully inserted, you still will be able to see the metal part of the connector as shown in the illustration.
- When connecting the USB cable to a USB port, make sure you align the connector correctly with the port.
- Your computer may not be able to recognize the camera if you connect via a USB hub. Always connect directly to the computer's USB port.

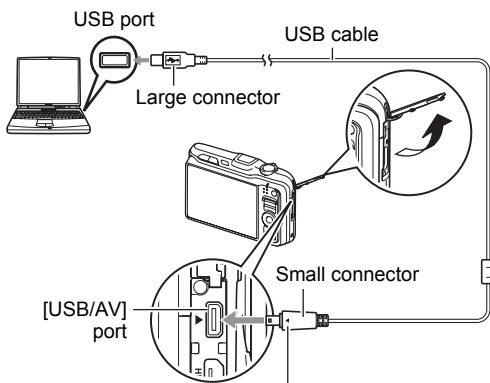

Making sure that the ▶ mark on the camera is aligned with the ◀ mark of the USB cable connector, connect the cable to the camera.

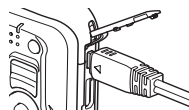

5. Turn on the camera.

The camera's back lamp will light green at this time. In this mode, your Macintosh recognizes the memory card loaded in the camera (or the camera's built-in memory if it does not have a memory card loaded) as a drive. The appearance of the drive icon depends on the Mac OS version you are using.

- 
6. Double-click the camera's drive icon.
  7. Drag the "DCIM" folder to the folder to which you want to copy it.
  8. After the copy operation is complete, drag the drive icon to Trash.
  9. On the camera, press [ON/OFF] (Power) to turn off the camera. After making sure that the green back lamp is unlit, disconnect the camera from the computer.

■ **To view copied images**

1. Double-click the camera's drive icon.
2. Double-click the "DCIM" folder to open it.
3. Double-click the folder that contains the images you want to view.
4. Double-click the image file you want to view.
  - For information about file names, see "Memory Folder Structure" on page 138.
  - An image that was rotated on the camera will be displayed on your Macintosh screen in its original (unrotated) orientation.

**Never use your computer to modify, delete, move, or rename any image files that are in the camera's built-in memory or on its memory card.**

Doing so can cause problems with the camera's image management data, which will make it impossible to play back images on the camera and can drastically alter remaining memory capacity. Whenever you want to modify, delete, move, or rename an image, do so only on images that are stored on your computer.

 **IMPORTANT!**

- Never unplug the USB cable, or operate the camera while viewing or storing images. Doing so can cause data to become corrupted.

## Transferring Images Automatically and Managing Them on Your Macintosh

---

If you are running Mac OS X, you can manage snapshots using iPhoto, which comes bundled with some Macintosh products. If you are running Mac OS 9, you will need to use commercially available software.

## Playing a Movie

---

You can use QuickTime, which comes bundled with your operating system, to play back movies on a Macintosh. To play back a movie, first copy it to your Macintosh and then double-click the movie file.

### ■ Minimum Computer System Requirements for Movie Playback

The minimum system requirements described below are necessary to play back movies recorded with this camera on a computer.

Operating System : Image Quality "HD":

Mac OS X 10.4.11 or higher

Image Quality "STD":

Mac OS X 10.3.9 or higher

Required Software: QuickTime 7 or higher

- The above are recommended system environments. Configuring one of these environments does not guarantee proper operation.
- Certain settings and other installed software may interfere with proper playback of movies.
- Movie file playback is not supported under OS 9.

### ■ Movie Playback Precautions

Proper movie playback may not be possible on some Macintosh models. If you experience problems, try the following.

- Upgrade to the latest version of QuickTime.
- Shut down other applications that are running.

Even if proper playback is not possible on your Macintosh, you can use the AV cable that comes bundled with the camera to connect to the video input terminal of a TV or Macintosh and play back movies that way.

### **IMPORTANT!**

- Be sure to move the movie data to the hard disk of your Macintosh before trying to play it. Proper movie playback may not be possible for data accessed over a network, from a memory card, etc.

## Viewing User Documentation (PDF Files)

You must have Adobe Reader or Adobe Acrobat Reader installed on your computer in order to view the contents of a PDF file. If you don't, go to the Adobe Systems Incorporated website and install Acrobat Reader.

- 1. On the CD-ROM, open the "Manual" folder.**
- 2. Open the "Digital Camera" folder and then open the folder for the language whose user's guide you want to view.**
- 3. Open the file named "camera\_xx.pdf".**
  - "xx" is the language code (Example: camera\_e.pdf is for English.).

## User Registration

Internet registration only is supported. Visit the following CASIO website to register:  
<http://world.casio.com/qv/register/>

## Using an Eye-Fi Wireless SD Memory Card to Transfer Images (Eye-Fi)

Shooting with an Eye-Fi wireless SD memory card loaded in the camera makes it possible to transfer image data automatically to a computer via wireless LAN.

- 1. Configure LAN access point, transfer destination and other settings for the Eye-Fi card in accordance with the instructions that come with the Eye-Fi card.**
- 2. After configuring settings, load the Eye-Fi card into the camera and record.**



Images you record are sent by wireless LAN to your computer, etc.



  - For full details, see the user documentation that comes with the Eye-Fi card.
  - Before formatting a new Eye-Fi card to use it for the first time, copy the Eye-Fi Manager install files to your computer. Do this before formatting the card.

## **IMPORTANT!**

- Recorded images are transferred over wireless LAN. Do not use the Eye-Fi card or turn off Eye-Fi card communication (page 140) when on an aircraft or in any other location where use of wireless communication is limited or prohibited.
- Loading an Eye-Fi card will cause the Eye-Fi indicator  to appear on the monitor screen. Its transparent or not transparent appearance indicates the communication status as shown below.



<b>Transparent</b>		Access point cannot be found or no transferable image data exists.
<b>Not transparent</b>		Image transfer in progress
<b>Flashing</b>		Searching for access points

- The Eye-Fi indicator  is not displayed in the MAP mode.
- A communication icon  will appear on the monitor screen while image data transfer is in progress.
- The camera's Auto Power Off (page 148) function is disabled while image data transfer is in progress.
- A confirmation message will appear on the monitor screen if you try to turn off the camera while image data transfer is in progress. Follow the instructions in the messages (page 176).
- Transfer of a large number of images can take some time to complete.
- Depending on the type of Eye-Fi card you are using and its settings, images on the Eye-Fi card may be deleted following image data transfer.
- When recording a movie to an Eye-Fi card, it can take too much time to record data, which can result in breaks in the image and/or audio.
- Proper Eye-Fi card data communication may not be possible due to camera settings, battery level, or operating conditions.



## Files and Folders

The camera creates a file and saves it each time you shoot a snapshot, record a movie, or perform any other operation that stores data. Files are grouped by storing them in folders. Each file and folder has its own unique name.

- For details about how folders are organized in memory, see “Memory Folder Structure” (page 138).

Name and Maximum Number Allowed	Example
<b>File</b>	
Each folder can contain up to 9999 files named CIMG0001 through CIMG9999. The extension on the file name depends on the file type.	26th file name:  CIMG0026.JPG                 Extension Serial number (4 digits)
<b>Folders</b>	
Folders are named from 100CASIO to 999CASIO. There can be up to 900 folders in memory. <ul style="list-style-type: none"><li>• BEST SHOT has a scene named “For YouTube” that optimizes movie settings for recording movies for upload to YouTube. Images recorded with the YouTube scene are stored in a folder named “100YOUTB”.</li></ul>	100th folder name:  100CASIO   Serial number (3 digits)

- You can view folder and file names on your computer. For details about how file names are displayed on the camera’s monitor screen, see page 12.
- The total number of folders and files allowed depends on the image size and quality, and capacity of the memory card being used for storage.

## Memory Card Data

The camera stores images you shoot in accordance with the Design Rule for Camera File System (DCF).

### ■ About DCF

The following operations are supported for DCF-compliant images. Note, however, that CASIO makes no performance guarantees concerning these operations.

- Transferring this camera's DCF-compliant images to another manufacturer's camera and view them.
- Printing this camera's DCF-compliant images on another manufacturer's printer.
- Transferring another camera's DCF-compliant images to this camera and view them.

### ■ Memory Folder Structure

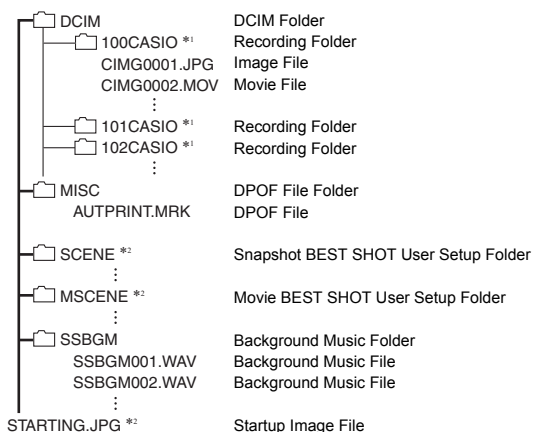

\*1 The BEST SHOT includes a scene named "For YouTube" that optimizes movie settings for recording movies for upload to YouTube. Images recorded with the YouTube scene are stored in a folder named "100YOUTB".

\*2 This folder or file can be created in built-in memory only.

## ■ Supported Image Files

- Image files shot with this camera
- DCF-compliant image files

This camera may not be able to display an image, even if it is DCF-compliant. When displaying an image recorded on another camera, it may take a long time for the image to appear on this camera's monitor screen.

## ■ Built-in Memory and Memory Card Data Handling Precautions

- Whenever copying memory contents to your computer, you should copy the DCIM folder and all of its contents. A good way to keep track of multiple DCIM copies of the DCIM folders is to change its name to a date or something similar after you copy it to your computer. If you later decided to return the folder to the camera, however, be sure to change its name back to DCIM. The camera is designed to recognize only a root file with the name DCIM. Note the camera also will not be able to recognize the folders inside the DCIM folder unless they have the names they originally had when you copied them from the camera to your computer.
- Folders and files must be stored in accordance with the "Memory Folder Structure" shown on page 138 in order for the camera to be able to recognize them correctly.
- You also can use a PC card adapter or a memory card reader/writer to access camera files directly from the camera's memory card.

## Other Settings (Set Up)

This section explains menu items that you can use to configure settings and perform other operations in the REC mode, PLAY mode, and MAP mode.

For information about menu operations, see page 58.

### Adjusting Monitor Screen Brightness (Screen)

#### Procedure

[MENU] → Set Up Tab → Screen

You can change the brightness of the monitor screen.

Auto	With this setting, the camera detects available light levels and automatically adjusts the brightness of the monitor screen accordingly.
+2	Brightness that is greater than +1, which makes the screen easier to view. This setting consumes more power.
+1	Bright setting for outdoor use, etc. Brightness that is greater than 0.
0	Normal monitor screen brightness for indoor use, etc.
-1	Screen brightness for viewing in a dark environment without disturbing others around you.

### Turning off Eye-Fi Card Communication (Eye-Fi)

#### Procedure

[MENU] → Set Up Tab → Eye-Fi

Select "Off" to disable Eye-Fi card communication (page 135).

## Enabling the GPS Function (GPS)

### Procedure

**[MENU] → Set Up Tab → GPS**

See page 92 for details.

## Recording Location Information with Image Data (Record Lat/Long)

### Procedure

**[MENU] → Set Up Tab → Record Lat/Long**

See page 93 for details.

## Auto Image Orientation Detection and Rotation (Auto Rotate)

### Procedure



**[MENU] → Set Up Tab → Auto Rotate**

See page 108 for details.

## Configuring Camera Sound Settings (Sounds)

### Procedure

[MENU] → Set Up Tab → Sounds

<b>Startup</b>	
<b>Half Shutter</b>	Specifies the startup sound.
<b>Shutter</b>	Sound 1 - 5: Built-in sounds (1 through 5) Off: Sound off
<b>Operation</b>	
 <b>Operation</b>	Specifies the sound volume. This setting is also used as the audio level during video output (page 76).
 <b>Play</b>	Specifies the volume of movie audio output. This volume setting is not used during video output (from the USB/AV port).

- Setting a volume level of 0 mutes output.

## Configuring a Startup Image (Startup)

### Procedure

[MENU] → Set Up Tab → Startup

Display the image you want to use as your startup image and then select “On”.

- The startup image does not appear when you turn on the camera by pressing [] (PLAY).
- You can specify a snapshot you recorded as the startup image, or you can use the special startup image provided in the camera’s built-in memory.
- Formatting built-in memory (page 151) will delete the current startup image setting.

## Specifying the File Name Serial Number Generation Rule (File No.)

### Procedure

[MENU] → Set Up Tab → File No.

Use the following procedure to specify the rule that governs generation of the serial number used in file names (page 137).

<b>Continue</b>	Tells the camera to remember the last used file number. A new file will be named using the next sequential number, even if files are deleted or if a blank memory card is loaded. If a memory card is loaded and that card already has files stored on it and the largest sequential number in the existing file names is greater than the largest sequential number remembered by the camera, numbering of new files will start from the largest sequential number in the existing file names plus 1.
<b>Reset</b>	Restarts the serial number from 0001 whenever all files are deleted or when the memory card is replaced with a blank one. If a memory card is loaded and that card already has files stored on it, numbering of new files will start from the largest sequential number in the existing file names number plus 1.

## Creating an Image Storage Folder (Create Folder)

### Procedure

[MENU] → Set Up Tab → Create Folder

<b>Create Folder</b>	Creates a folder with a unique number (page 137). Files will be stored in the new folder starting from when you record your next image.
<b>Cancel</b>	Cancels folder creation.

- Images recorded with the BEST SHOT “For YouTube” scene are stored in special folders. They are not stored in the folder you create here.

## Configuring World Time Settings (World Time)

### Procedure

#### [MENU] → Set Up Tab → World Time

You can use the World Time screen to view the current time in a zone that is different from your Home City when you go on a trip, etc. World Time displays the current time in 162 cities in 32 time zones around the globe.

**1. Use [▲] and [▼] to select “World” and then press [▶].**

- To change the geographic area and city for the time where you normally use the camera, select “Home”.

**2. Use [▲] and [▼] to select “City” and then press [▶].**

- To change the “World” setting to summer time, use [▲] and [▼] to select “DST” and then select “On”. Summer time is used in some geographical areas to advance the current time setting by one hour during the summer months.

**3. Use [▲], [▼], [◀], and [▶] to select the geographic area you want and then press [SET].**

**4. Use [▲] and [▼] to select the city you want and then press [SET].**

**5. Press [SET].**



### **IMPORTANT!**

- Before configuring World Time settings, make sure that the Home City setting is the place where you live or normally use the camera. If it isn't, select “Home” on the screen in step 1 and configure the Home City, date, and time settings as required (page 146).
- You can configure the camera to use time data received from the GPS satellites to automatically adjust World Time settings in accordance with the current time. For more information, see “Correcting Camera Clock Settings Automatically (Time Auto Correct)” (page 108).



## Time Stamping Snapshots (Timestamp)

### Procedure

**[MENU] → Set Up Tab → Timestamp**

You can configure the camera to stamp the recording date only, or date and time in the lower right corner of each snapshot.

- Once date and time information is stamped into a snapshot, it cannot be edited or deleted.

Example: July, 10, 2012, 1:25 p.m.

<b>Date</b>	2012/7/10
<b>Date&amp;Time</b>	2012/7/10 1:25pm
<b>Off</b>	No stamping of date and/or time

- Even if you do not stamp the date and/or time with Timestamp, you can do so later using the DPOF function or some printing application (page 119).
- Time stamping is disabled when certain BEST SHOT scenes are being used.

## Stamping a Place Name into an Image (Stamp Place)

### Procedure

**[MENU] → Set Up Tab → Stamp Place**

See page 96 for details.

## Adjusting the Camera Clock Setting Automatically (Time Auto Correct)

### Procedure

**[MENU] → Set Up Tab → Time Auto Correct**

See page 108 for details.

## Setting the Camera's Clock (Adjust)

### Procedure

[MENU] → Set Up Tab → Adjust

[▲] [▼]	Change the setting at the cursor location
[◀] [▶]	Move the cursor between settings
[BS]	Toggles between 12-hour and 24-hour format

When the date and time settings are what you want, press [SET] to apply them.

- You can specify a date from 2001 to 2049.
- Be sure to select your Home City (page 144) before setting the time and date. If you set the time and date while the wrong city is selected for your Home City, the times and dates of all of the World Time cities (page 144) will be wrong.

## Specifying the Date Style (Date Style)

### Procedure

[MENU] → Set Up Tab → Date Style

You can select from among three different styles for the date.

Example: July, 10, 2012

YY/MM/DD	12/7/10
DD/MM/YY	10/7/12
MM/DD/YY	7/10/12

- This setting also affects the Control Panel date format as shown below (page 34).  
YY/MM/DD or MM/DD/YY: MM/DD  
DD/MM/YY: DD/MM

## Specifying the Display Language (Language)

### Procedure

[MENU] → Set Up Tab → Language

#### ■ Specify the display language you want.

① Select the tab on the right.

② Select "Language".

③ Select the language you want.

- Camera models sold in certain geographic areas may not support display language selection.
- Place names (country, landmark), city names, recommended photogenic spot names, and place name candidates (country, city, landmark) when shooting may not match the language you select with this setting. Place names and proper names in map data, recommended photogenic spot data, and place name data are displayed in the languages used when the data was originally compiled.

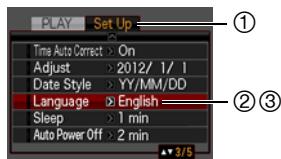

## Configuring Sleep State Settings (Sleep)

### Procedure

[MENU] → Set Up Tab → Sleep

This feature turns off the monitor screen whenever no camera operation is performed for a preset amount of time. Press any button to turn the monitor screen back on.

Trigger Time Settings: 30 sec, 1 min, 2 min, Off (Sleep is disabled while "Off" is selected.)

- Sleep is disabled under any of the following conditions.
  - In the PLAY mode
  - In the MAP mode
  - While the camera is connected to a computer or other device
  - During a slideshow
  - During "P-AF Tracking"
  - During movie recording and playback
- When both sleep and Auto Power Off are turned on, Auto Power Off takes priority.

## Configuring Auto Power Settings (Auto Power Off)

### Procedure

#### [MENU] → Set Up Tab → Auto Power Off

Auto Power Off turns off the camera whenever no camera operation is performed for a preset amount of time.

Trigger Time Settings: 1 min, 2 min, 5 min (The trigger time is always 5 minutes in the PLAY mode.)

- Auto Power Off is disabled under any of the following conditions.
  - While the camera is connected to a computer or other device
  - During a slideshow
  - During “AF Tracking”
  - During movie recording and playback

## Configuring [CAMERA], [PLAY], and [MAP] Settings (REC/PLAY)

### Procedure

#### [MENU] → Set Up Tab → REC/PLAY

<b>Power On</b>	Camera turns on whenever [CAMERA] (REC), [PLAY] (PLAY), or [MAP] (MAP) is pressed.
<b>Power On/Off</b>	Camera turns on or off whenever [CAMERA] (REC) or [PLAY] (PLAY) is pressed.
<b>Disable</b>	Camera does not turn on or off whenever [CAMERA] (REC), [PLAY] (PLAY), or [MAP] (MAP) is pressed.

- With “Power On/Off”, the camera turns off when you press [CAMERA] (REC) in the REC mode or [PLAY] (PLAY) in the PLAY mode.
- While the “Power On/Off” setting is selected, pressing [MAP] (MAP) will turn on power only. It will not turn off power.
- Change this setting to anything besides “Disable” before connecting to a TV for image viewing.

## Disabling File Deletion (🗑️ Disabled)

### Procedure

[MENU] → Set Up Tab → 🗑️ Disabled

The camera will not start the image delete operation when you press [▼] (🗑️ ⚡) while “🗑️ Disabled” is turned on.

You can protect against accidental deletion of images by selecting “On” for “🗑️ Disabled”.

## Configuring USB Protocol Settings (USB)

### Procedure

[MENU] → Set Up Tab → USB

You can use the procedure below to select the USB communication protocol, which is used when exchanging data with a computer, printer, or other external device.

<b>Mass Storage</b>	Select this setting when connecting to a computer (pages 122, 132). With this setting, the computer sees the camera as an external storage device. Use this setting for normal transfer of images from the camera to a computer.
<b>PTP (PictBridge)</b>	Select this setting when connecting to a printer that supports PictBridge (page 115). This setting simplifies the transfer of image data to the connected device.

## Selecting the Screen Aspect Ratio and Video Output System (Video Out)

### Procedure

#### [MENU] → Set Up Tab → Video Out

You can use the procedure in this section to select either NTSC or PAL as the video output system. You can also specify an aspect ratio of 4:3 or 16:9.

<b>NTSC</b>	Video system used in Japan, the U.S., and other countries
<b>PAL</b>	Video system used in Europe and other areas
<b>4:3</b>	Normal TV screen aspect ratio
<b>16:9</b>	Wide screen aspect ratio

- Select the aspect ratio (4:3 or 16:9) that matches the type of TV you plan to use. Images will not display correctly if you select the wrong aspect ratio.
- Images will not display correctly unless the camera's video signal output setting matches the video signal system of the TV or other video equipment.
- Images cannot be displayed correctly on a TV or video equipment that is not NTSC or PAL.

## Selecting the HDMI Terminal Output Method (HDMI Output)

### Procedure

#### [MENU] → Set Up Tab → HDMI Output

See page 79 for details.

## Formatting Built-in Memory or a Memory Card (Format)

### Procedure

#### [MENU] → Set Up Tab → Format

If a memory card is loaded in the camera, this operation will format the memory card. It will format built-in memory if no memory card is loaded.

- The format operation will delete all contents on the memory card or in built-in memory. It cannot be undone. Make sure you do not need any data currently on the card or in built-in memory before you format it.
- Formatting built-in memory will delete the following data.
  - Protected images
  - BEST SHOT user setups
  - Startup screen
  - Location information (latitude, longitude, camera aiming direction) obtained when shooting images
- Formatting a memory card will delete the following data.
  - Protected images
- Make sure the camera's battery is sufficiently charged before starting a formatting operation. Formatting may not be performed correctly and the camera may stop operating normally if the camera powers down while formatting is in progress.
- Never open the battery cover while formatting is in progress. Doing so can cause the camera to stop operating normally.

## Resetting the Camera to Factory Defaults (Reset)

### Procedure

#### [MENU] → Set Up Tab → Reset

See page 167 for details about the camera's factory default settings.

The settings below are not reset.

World Time settings, clock settings, date style, screen language, video output

# Configuring Monitor Screen Settings

You can turn display information on and off by pressing [▲] (DISP). You can configure separate settings for the REC mode and PLAY mode.

<b>Information display on</b>	Displays information about image settings, etc.
<b>Information display + Histogram on</b>	Turns on display of camera setting and other indicators, along with a histogram (page 153).  Histogram
<b>Information display off</b>	No information displayed

## Using the On-screen Histogram to Check Exposure

Displays a histogram on the monitor screen which you can use to check the exposure of an image before you shoot it. You also can display the histogram in the PLAY mode for information about the exposure levels of images.



Histogram

### NOTE

- A centered histogram does not necessarily guarantee optimum exposure. The recorded image may be over-exposed or under-exposed, even though its histogram is centered.
- Due to the limitations of exposure compensation, you may not be able to achieve an optimum histogram configuration.
- Use of the flash and certain shooting conditions can cause the histogram to indicate exposure that is different from the actual exposure of the image when it is shot.



## How to Use the Histogram

A histogram is a graph that represents the lightness of an image in terms of the number of pixels. The vertical axis indicates the number of pixels, while the horizontal axis indicates lightness. If the histogram appears too lopsided for some reason, you can use EV shift to move it left or right in order to achieve better balance. Optimum exposure can be achieved by EV shifting so the graph is as close to the center as possible. For snapshots, you can even display individual histograms for R (red), G (green), and B (blue).

### Example Histograms

A histogram towards the left side results when the overall image is dark. A histogram that is too far to the left may result in “black out” of the dark areas of an image.



A histogram towards the right side results when the overall image is light. A histogram that is too far to the right may result in “white out” of the light areas of an image.



An overall well-balanced histogram results when the overall image is at optimal lightness.



## Precautions during Use

### ■ Avoid Use While In Motion

- Never use the camera to record or play back images while operating an automobile or other vehicle, or while walking. Looking at the monitor while in motion creates the risk of serious accident.

### ■ Directly Viewing the Sun or Bright Light

- Never look at the sun or any other bright light through the camera's viewfinder. Doing so can damage your eyesight.

### ■ Flash

- Never use the flash unit in areas where flammable or explosive gas may be present. Such conditions create the risk of fire and explosion.
- Never fire the flash in the direction of a person operating a motor vehicle. Doing so can interfere with the driver's vision and creates the risk of accident.
- Never fire the flash too close to the eyes of the subject. Doing so creates the risk of loss of eyesight.

### ■ Monitor Screen

- Should the monitor screen ever become cracked, never touch any of the liquid inside the monitor screen. Doing so creates the risk of skin inflammation.
- Should monitor screen liquid ever get into your mouth, immediately rinse your mouth out and contact your physician.
- Should monitor screen liquid ever get into your eyes or onto your skin, immediately rinse with clean water for at least 15 minutes and contact your physician.

### ■ Connections

- Never plug any devices that are not specified for use with this camera into connectors. Connecting a non-specified device creates the risk of fire and electric shock.

### ■ Transport

- Never operate the camera inside of an aircraft or anywhere else where operation of such devices is restricted. Improper use creates the risk of serious accident.

### ■ **Smoke, abnormal odor, overheating, and other abnormalities**

- Continued use of the camera while it is emitting smoke or strange odor, or while it is overheating creates the risk of fire and electric shock. Immediately perform the following steps whenever any of the above symptoms are present.
  1. Turn off the camera.
  2. Remove the battery from the camera, taking care to protect yourself against burn injury.
  3. Contact your dealer or nearest CASIO authorized service center.

### ■ **Water and Foreign Matter**

- Water, other liquids, or foreign matter (especially metal) getting inside the camera creates the risk of fire and electric shock. Immediately perform the following steps whenever any of the above symptoms are present. Particular care is required when using the camera where it is raining or snowing, near the ocean or other body of water, or in a bathroom.
  1. Turn off the camera.
  2. Remove the battery from the camera.
  3. Contact your dealer or nearest CASIO authorized service center.

### ■ **Dropping and Rough Treatment**

- Continued use of the camera after it is damaged by dropping or other rough treatment creates the risk of fire and electric shock. Immediately perform the following steps whenever any of the above symptoms are present.
  1. Turn off the camera.
  2. Remove the battery from the camera.
  3. Contact your dealer or nearest CASIO authorized service center.

### ■ **Keep Away From Fire**

- Never expose the camera to fire, which can cause it to explode and creates the risk of fire and electric shock.

### ■ **Disassembly and Modification**

- Never try to take the camera apart or modify it in any way. Doing so creates the risk of electric shock, burn injury, and other personal injury. Be sure to leave all internal inspection, maintenance, and repair up to your dealer or nearest CASIO authorized service center.

## ■ Locations To Be Avoided

- Never leave the camera in any of the following types of locations. Doing so creates the risk of fire and electric shock.
  - Areas subject to large amounts of humidity or dust
  - Food preparation areas or other locations where oil smoke is present
  - Near heaters, on a heated carpet, in areas exposed to direct sunlight, in a closed vehicle parked in the sun, or other areas subject to very high temperatures
- Never place the camera on an unstable surface, on a high shelf, etc. Doing so can cause the camera to fall, creating the risk of personal injury.

## ■ Backing Up Important Data

- Always keep backup copies of important data in camera memory by transferring it to a computer or other storage device. Note that data can be deleted in the case of camera malfunction, repair, etc.

## ■ Memory Protection

- Whenever replacing the battery, be sure to follow the correct procedure as described in the documentation that comes with the camera. Incorrectly replacing the battery can result in corruption or loss of data in camera memory.

## ■ Rechargeable Battery

- Use only the specified charger unit or the specified device to charge the battery. Attempting to charge the battery by an unauthorized means creates the risk of battery overheating, fire, and explosion.
- Do not expose or immerse the battery in fresh water or salt water. Doing so can damage the battery, and cause deterioration of its performance and loss of service life.
- The battery is intended for use with a CASIO Digital Camera only. Use with any other device creates the risk of the battery damage, or deterioration of battery performance and service life.
- Failure to observe any of the following precautions creates the risk of battery overheating, fire, and explosion.
  - Never use or leave the battery near open flame.
  - Do not expose the battery to heat or fire.
  - Make sure the battery is oriented correctly when it is connected to the charger unit.
  - Never carry or store the battery together with items that can conduct electricity (necklaces, pencil lead, etc.).
  - Never disassemble the battery, pierce it with a needle, or expose it to strong impact (hit it with a hammer, step on it, etc.), and never apply solder to it. Never place the battery into a microwave oven, heater, high-pressure generating device, etc.

- Should you ever notice leakage, strange odor, heat generation, discoloration, deformation, or any other abnormal condition while using, charging, or storing a battery, immediately remove it from the camera or charger unit and keep it away from open flame.
- Do not use or leave the battery under direct sunlight, in an automobile parked in the sun, or in any other area subject to high temperatures. Doing so can damage the battery, and cause deterioration of its performance and loss of service life.
- If battery charging does not end normally within the specified charging time, stop charging anyway and contact your local CASIO authorized service center. Continued charging creates the risk of battery overheating, fire, and explosion.
- Battery fluid can damage your eyes. Should battery fluid get into your eyes accidentally, immediately rinse them with clean tap water and then consult a physician.
- Be sure to read the user documentation that comes with the camera and special charger unit before using or charging the battery.
- If a battery is to be used by young children, make sure that a responsible adult makes them aware of the precautions and proper handling instructions, and make sure that they handle the battery correctly.
- Should fluid from a battery accidentally get onto clothing or your skin, immediately rinse it off with clean tap water. Prolonged contact with battery fluid can cause skin irritation.

## ■ Battery Life

- Battery continuous operation times provided in this manual represent the approximate amount of time before the camera turns off due to low battery power when being powered by the special battery under normal temperature (23°C (73°F)). They do not guarantee that you will be able to achieve the indicated level of operation. Actual battery life is greatly affected by ambient temperature, battery storage conditions, the amount of time spent in storage, etc.
- Leaving the camera on can run down the battery and cause the low battery warning to appear. Turn off the camera whenever you are not using it.
- The low battery warning indicates that the camera is about to turn off due to low battery power. Charge the battery as soon as possible. Leaving a low or dead battery in the camera can lead to battery leakage and data corruption.

## ■ Data Error Precautions

Your digital camera is manufactured using precision digital components. Any of the following creates the risk of corruption of data in camera memory.

- Removing the battery or memory card while the camera is performing some operation
- Removing the battery or memory card while the back lamp is flashing green after turning off the camera
- Disconnecting the USB cable while communication is in progress
- Using a battery that is low
- Other abnormal operations

Any of the above conditions can cause an error message to appear on the monitor screen (page 176). Perform the action indicated by the message that appears.

## ■ Operating Environment

- Operating Temperature Requirements: 0 to 40°C (32 to 104°F)
- Operating Humidity: 10 to 85% (non condensation)
- Do not place the camera in any of the following locations.
  - In an area exposed to direct sunlight, or large amounts of moisture, dust, or sand
  - Near an air conditioner or in other areas subjected to extreme temperature or humidity
  - Inside of a motor vehicle on a hot day, or in an area subjected to strong vibration

## ■ Condensation

Sudden and extreme temperature changes, such as when the camera is moved from the outdoors on a cold winter day into a warm room, can cause water droplets called “condensation” to form on the interior and the exterior of the camera, which creates the risk of malfunction. To prevent condensation from forming seal the camera in a plastic bag before changing locations. Then leave the bag sealed to allow the air inside to naturally change to the same temperature as the air in the new location. After that, remove the camera from the bag and open the battery cover for a few hours.

## ■ Lens

- Never apply too much force when cleaning the surface of the lens. Doing so can scratch the lens surface and cause malfunction.
- You may sometimes notice some distortion in certain types of images, such as a slight bend in lines that should be straight. This is due to the characteristics of lenses, and does not indicate malfunction of the camera.

## ■ Caring for your camera

- Never touch the lens or flash window with your fingers. Finger smudges, dirt, and other foreign matter on the lens or flash window can interfere with proper operation of the camera. Use a blower or other means to keep the lens and flash window free of dirt and dust, and wipe gently with a soft, dry cloth.
- To clean the camera, wipe it with a soft, dry cloth.

## ■ Old Rechargeable Battery Handling Precautions

- Insulate the positive and negative terminals with tape, etc.
- Do not peel the covering off of the battery.
- Do not try to take the battery apart.

## ■ Charger Unit Handling Precautions



- Never plug the power cord into an outlet whose voltage rating is different from that marked on the power cord. Doing so creates the risk of fire, malfunction, and electric shock.
  - Take care to protect the power cord against damage and breaking. Never place heavy objects onto the power cord, or expose it to intense heat. Doing so can damage the power cord, creating the risk of fire and electric shock.
  - Never try to modify the power cord, or subject it to severe bending, twisting, or pulling. Doing so creates the risk of fire, malfunction, and electric shock.
  - Never plug in or unplug the power cord while your hands are wet. Doing so creates the risk of electric shock.
  - Do not plug the power cord into an outlet or extension cord that is shared by other devices. Doing so creates the risk of fire, malfunction, and electric shock.
  - Should the power cord ever become damaged (to the point that internal wires are exposed or cut), immediately contact your original retailer or a CASIO authorized service center to request repair. Continued use of a damaged power cord creates the risk of fire, malfunction, and electric shock.
- The charger unit becomes slightly warm during charging. This is normal and does not indicate malfunction.
  - Unplug the power cord from the power outlet when you are not using the charger unit.
  - Never use detergent to clean the power cord (especially the plug).
  - Never cover the charger unit with a blanket, etc. Doing so creates the risk of fire.

## ■ Other Precautions

The camera becomes slightly warm during use. This is normal and does not indicate malfunction.

## ■ Copyrights

Except for your own personal enjoyment, unauthorized use of use of snapshots or movies of images whose rights belong to others, without the permission of the right holder, is forbidden by copyright laws. In some cases, shooting of public performances, shows, exhibitions, etc. may be restricted entirely, even if it is for your own personal enjoyment. Regardless of whether such files are purchased by you or obtained for free, posting them on a website, a file sharing site, or any other Internet site, or otherwise distributing them to third parties without the permission of the copyright holder is strictly prohibited by copyright laws and international treaties. For example, uploading or distributing on the Internet images of TV programs, live concerts, music videos, etc. that were photographed or recorded by you may infringe upon the rights of others. Note that CASIO COMPUTER CO., LTD. shall not be held liable for use of this product in any way that infringes on the copyrights of others or that violates copyright laws.

The following terms, which are used in this manual, are registered trademarks or trademarks of their respective owners.

Note that trademark <sup>™</sup> and registered trademark <sup>®</sup> are not use within the text of this manual.

- SDXC Logo is a trademark of SD-3C, LLC.
- Microsoft, Windows, Internet Explorer, Windows Media, Windows Vista, Windows 7, and DirectX are registered trademarks or trademarks of Microsoft Corporation in the United States and other countries.
- Macintosh, Mac OS, QuickTime, and iPhoto are trademarks of Apple Inc.
- Adobe and Reader are trademarks or registered trademarks in the United States and other countries of Adobe Systems Incorporated.
- YouTube, the YouTube logo, and "Broadcast Yourself" are trademarks or registered trademarks of YouTube, LLC.
- HDMI, the HDMI logo, and High-Definition Multimedia Interface are trademarks or registered trademarks of HDMI Licensing, LLC.
- Google, Google Earth and Picasa are trademarks of Google Inc.
- EXILIM, Hybrid-GPS, Photo Transport, Dynamic Photo, and YouTube Uploader for CASIO are registered trademarks or trademarks of CASIO COMPUTER CO., LTD.
- All other company or product names mentioned herein are registered trademarks or trademarks of their respective companies.



Any and all unauthorized commercial copying, distribution, and copying of the bundled software over a network are prohibited.

This product's YouTube upload functionality is included under license from YouTube, LLC. The presence of YouTube upload functionality in this product is not an endorsement or recommendation of the product by YouTube, LLC.

## Power Supply

### Charging

#### If the [CHARGE] lamp flashes red...

- Charging cannot be performed because ambient temperature or the temperature of the charger is too hot or too cold. Leave the camera in a location whose temperature is within the range where charging can be performed. When the camera returns to a temperature where charging can be performed, the [CHARGE] lamp will light red.
- Check if the charger and battery contacts are dirty. If contacts are dirty, wipe them clean with a dry cloth.

If problems continue to occur after you perform the above steps, it could mean that the battery is faulty. Contact your nearest CASIO authorized service center.

### To replace the battery

#### 1. Open the battery cover and remove the current battery.

With the monitor screen side of the camera facing upwards, slide the stopper in the direction indicated by the arrow in the illustration. After the battery pops out, pull it the rest of the way out of the camera.

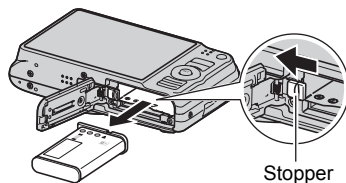

#### 2. Load a new battery.

## Battery Precautions

---

### ■ Precautions during Use

- Operation provided by a battery under cold conditions is always less than operation under normal temperatures. This is due to the characteristics of the battery, not the camera.
- Charge the battery in an area where the temperature is within the range of 5°C to 35°C (41°F to 95°F). Outside this temperature range charging can take longer than normal or even fail.
- Do not tear or remove the battery outer label.
- If a battery provides only very limited operation following a full charge, it probably means the battery has reached the end of its service life. Replace the battery with a new one.

### ■ Storage Precautions

- Storing the battery for a long time while it is charged can cause deterioration of battery characteristics. If you do not plan to use a battery for some time, fully use up its charge before storing it.
- Always remove the battery from the camera when you are not using it. A battery left in the camera can discharge and go dead, which will require some time to charge when you need to use the camera.
- Store batteries in a cool, dry place (20°C (68°F) or lower).
- To prevent over discharging of an unused battery, fully charge it, and then load it in the camera and fully use up the charge about once every six months.

## Using the Camera in another Country

---

### ■ Precautions during Use

- The bundled charger is designed for operation with any power supply in the range of 100V to 240V AC, 50/60Hz. Note, however, that the shape of the power cord plug depends on each country or geographic area. Before taking the camera and charger along on a trip, check with travel agent about the power supply requirements in your destination(s).
- Do not connect the charger to a power supply through a voltage converter or similar device. Doing so can lead to malfunction.

### ■ Extra Batteries

- Taking along extra fully charged batteries (NP-90) is recommended while on a trip in order to avoid not being able to shoot images due to the battery going dead.

## Using a Memory Card

See page 22 for information about supported memory cards and how to load a memory card.

### To replace the memory card

Press the memory card and then release it. This will cause it to pop out of the memory card slot slightly. Pull the card out the rest of the way and then insert another one.

- Never remove a card from the camera while the back lamp is flashing green. Doing so can cause the image save operation to fail and even damage the memory card.

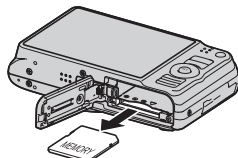

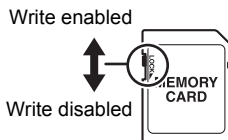

### Using a Memory Card

- SD memory cards, SDHC memory cards, and SDXC memory cards have a write protect switch. Use the switch when you need to guard against accidentally deleting data. Note, however, if you write protect an SD memory card you must then turn write protection off whenever you want to record to it, format it, or delete any of its images.
- If a memory card starts to behave abnormally during image playback, you can restore normal operation by reformatting it (page 151). However, it is recommended that you always take along multiple memory cards whenever using the camera far away from the home or office.
- As you record data to and delete data from a memory card a number of times, it loses its ability to retain data. Because of this, periodic re-formatting of a memory card is recommended.
- Electrostatic charge, electrical noise, and other phenomena can cause data to become corrupted or even lost. Make sure that you always back up important data on other media (CD-R, CD-RW, hard disk, etc.).



## ■ Memory Card Handling Precautions

Certain types of memory cards can slow down processing speeds. In particular, you may experience problems saving high-quality (HD and STD) movies. When using the camera's built-in memory or certain types of memory cards, it can take too much time to record data, which can result in breaks in the image and/or audio. This condition is indicated by  and  flashing on the monitor screen. Use of a memory card with a maximum transfer speed of at least 10MB per second is recommended.

## ■ Discarding or Transferring Ownership of a Memory Card or the Camera

The format and delete functions of the camera do not actually delete files from the memory card. The original data remains on the card. Note that responsibility for the data on a memory card lies with you. The following procedures are recommended whenever you discard a memory card or the camera, or if you transfer ownership to another party.

- When discarding a memory card, either physically destroy the memory card or use commercially available data delete software to completely delete the data on the memory card.
- When transferring ownership of a memory card to another party, use commercially available data deletion software to completely delete the data on it.
- Use the format function (page 151) to completely delete the data in built-in memory before discarding or transferring ownership of the camera.

## Computer System Requirements for Bundled Software (Bundled CD-ROM)

Computer system requirements are different for each of the applications. Be sure to check the requirements for the particular application you are trying to use. Note that the values provided here are minimum requirements for running each application. Actual requirements are greater, depending on the number of images and the sizes of the images being handled.

### ● Windows

#### **YouTube Uploader for CASIO**

Operating System : Windows 7, Windows Vista, Windows XP (SP2/SP3),  
Windows 2000 (SP4)

- Sufficient memory to run the operating system
- Computer configuration that enables playback of movies on the YouTube site
- Computer configuration that enables upload of movies to the YouTube site

#### **Photo Transport 1.0**

Operating System : Windows 7, Windows Vista, Windows XP, Windows 2000

Memory : At least 64MB

Hard Disk Drive Space : At least 2MB

**Picasa**

Operating System: Windows 7, Windows Vista, Windows XP

**Google Earth**

Operating System: Windows Vista, Windows XP, Windows 2000

**Adobe Reader 9**

Operating System : Windows 7, Windows Vista, Windows XP (SP2/SP3),  
Windows 2000 (SP4)

Memory : At least 128MB (256MB recommended)

Hard Disk Drive Space: At least 335MB

Other : Internet Explorer 6.0 or higher installed

For details about the minimum system requirements for each software application, see the “Read me” files on the CASIO Digital Camera Software CD-ROM that comes bundled with the camera.

## Reset Initial Default Settings

The tables in this section show the initial default settings that are configured for menu items (displayed when you press [MENU]) after you reset the camera (page 151).

Menu items depend on whether the camera is in the REC mode or PLAY mode.

- A dash (-) indicates an item whose setting is not reset or an item for which there is no reset setting.



### IMPORTANT!

- Switching from “Auto” to “Premium Auto” (page 26) will make some menu items unavailable.



## ■ REC Mode

### “REC” Tab

Focus	<b>AF</b> (Auto Focus)
Self-timer	Off
Face Detection	Off
Continuous AF	Off
Anti Shake	Auto
AF Area	Spot
AF Assist Light	On
Focus Frame	[ ]
Digital Zoom	On
Grid	Off
Review	On
Icon Help	On



Memory	<b>BS</b> BEST SHOT: Off / Effect: Off / Flash: On / Focus: Off / White Balance: Off / ISO: Off / AF Area: On / Metering: Off / Self-timer: Off / Flash Intensity: Off / Single SR Quality: On / Single SR Zoom: On / Digital Zoom: On / MF Position: Off / Zoom Position: Off
--------	--

## “Quality” Tab

Single SR Quality	Off
Single SR Zoom	On
Size	14M (4320×3240)
 Quality (Snapshots)	Normal
 Quality (Movies)	HD
Effect	Off
EV Shift	0.0

White Balance	Auto
ISO	Auto
Metering	 Multi
Lighting	On
Color Filter	Off
Sharpness	0
Saturation	0
Contrast	0
Flash Intensity	0

## “Set Up” Tab

Screen	Auto
Eye-Fi	On
GPS	Off
Record Lat/Long	On
Auto Rotate	On
Sounds	Startup: Sound 1 / Half Shutter: Sound 1 / Shutter: Sound 1 / Operation: Sound 1 /  Operation: ■■■■□□□□ /  Play: ■■■□□□□□
Startup	Off
File No.	Continue
Create Folder	–
World Time	Home
Timestamp	Off

Stamp Place	Off
Time Auto Correct	Off
Adjust	–
Date Style	–
Language	–
Sleep	1 min
Auto Power Off	2 min
REC/PLAY	Power On
 Disabled	Off
USB	Mass Storage
Video Out	–
HDMI Output	Auto
Format	–
Reset	–



## ■ PLAY Mode

### “PLAY” Tab

<b>Slideshow</b>	Images: All images / Time: 30 min / Interval: 3 sec / Effect: Pattern 1
<b>Dynamic Photo</b>	–
<b>Movie Converter</b>	–
<b>MOTION PRINT</b>	Create
<b>Movie Editing</b>	–
<b>Lighting</b>	–
<b>White Balance</b>	–

<b>Brightness</b>	0
<b>DPOF Printing</b>	–
<b>Protect</b>	–
<b>Date/Time</b>	–
<b>Delete Site Info</b>	–
<b>Rotation</b>	–
<b>Resize</b>	–
<b>Trimming</b>	–
<b>Copy</b>	–

### “Set Up” Tab

- The contents of the “Set Up” tab are the same in the REC mode and PLAY mode.

## ■ MAP Mode

### “MAP” Tab

<b>Save Log</b>	On
<b>Show Log</b>	On
<b>Log Period</b>	1 day







<b>Move Cursor</b>	On
<b>Direction Adj</b>	Cancel
<b>Update Info</b>	Cancel



### “Set Up” Tab

- The contents of the “Set Up” tab are the same in the REC mode and MAP mode.

## Troubleshooting

Problem	Possible Cause and Recommended Action
<b>Power Supply</b>	
Power does not turn on.	<ol style="list-style-type: none"> <li>1)The battery may not be loaded correctly (page 18).</li> <li>2)The battery may be dead. Charge the battery (page 17). If the battery goes dead soon after being charged, it means the battery has reached the end of its life and needs to be replaced. Purchase a separately available CASIO NP-90 rechargeable lithium ion battery.</li> </ol>
The camera suddenly powers down.	<ol style="list-style-type: none"> <li>1)Auto Power Off may have activated (page 148). Turn power back on.</li> <li>2)The battery may be dead. Charge the battery (page 17).</li> <li>3)The camera's protection function may have activated because camera temperature is too high. Turn off the camera and wait until it cools down before trying to use it again.</li> </ol>
Power will not turn off. Nothing happens when a button is pressed.	Remove the battery from the camera and then reload it.
<b>Image Recording</b>	
Image is not recorded when the shutter button is pressed.	<ol style="list-style-type: none"> <li>1)If the camera is in the PLAY mode, press [RECORD] (REC) to enter the REC mode.</li> <li>2)If the flash is charging, wait until the charge operation finishes.</li> <li>3)If the message "Memory Full" appears, transfer images to your computer, delete images you no longer need, or use a different memory card.</li> </ol>
Auto Focus does not focus properly.	<ol style="list-style-type: none"> <li>1)If the lens is dirty, clean it off.</li> <li>2)The subject may not be in the center of the focus frame when you compose the image.</li> <li>3)The subject you are shooting may not be a type that is compatible with Auto Focus (page 33). Use manual focus (page 39).</li> <li>4)You may be moving the camera when shooting. Try shooting with Anti Shake or use a tripod.</li> <li>5)You may be pressing the shutter button all the way without waiting for Auto Focus. Half-press the shutter button and allow enough time for Auto Focus to focus.</li> </ol>

Problem	Possible Cause and Recommended Action
The subject is out of focus in the recorded image.	The image may not be focused properly. When composing the image, make sure the subject is located inside the focus frame.
The flash does not fire.	1) If  (Flash Off) is selected as the flash mode, change to another mode (page 37). 2) If the battery is dead, charge it (page 17). 3) If a BEST SHOT scene that uses  (Flash Off) is selected, change to a different flash mode (page 37) or select a different BEST SHOT scene (page 52).
The  (Flash Off) icon flashes red on the monitor screen and the flash does not fire.	The flash unit may be malfunctioning. Contact a CASIO authorized service center or your original retailer. Note that though the flash will not fire, you still can use the camera for non-flash shots.
Camera powers down during Self-timer countdown.	The battery may be dead. Charge the battery (page 17).
The monitor screen image is out of focus.	1) You may be using Manual Focus and have not focused the image. Focus the image (page 39). 2) You may be using  (Macro) for scenery or portraits. Use Auto Focus for scenery and portrait shots (page 39). 3) You may be trying to use Auto Focus or  (Infinity) when shooting a close-up shot. Use the  (Macro) for close ups (page 39).
There is a vertical line in the monitor screen image.	Shooting a very brightly lit subject can cause a vertical band to appear in the monitor screen image. This is a CCD phenomenon known as “vertical smear”, and does not indicate malfunction of the camera. Note that vertical smear is not recorded with the image in the case of a snapshot, but it is recorded in the case of a movie.
There is digital noise in images.	1) Sensitivity may have been increased automatically for a dark subject, which increases the chance of digital noise. Use a light or some other means to illuminate the subject. 2) You may be attempting to shoot in a dark location with  (Flash Off) selected, which can increase digital noise and make images appear coarse. In this case, turn on flash (page 37) or use lights for illumination. 3) Shooting with a high ISO sensitivity setting or with the Lighting feature can cause an increase in digital noise. Use a light or some other means to illuminate the subject.

Problem	Possible Cause and Recommended Action
A recorded image was not saved.	1) Camera power may have been turned off before the save operation was complete, which will result in the image not being saved. If the battery indicator shows  , charge the battery as soon as possible (page 19). 2) You may have removed the memory card from the camera before the save operation was complete, which will result in the image not being saved. Do not remove the memory card before the save operation is complete.
Though available lighting is bright, the faces of people in the image are dark.	Not enough light is reaching the subjects. Change the flash mode setting to  (Flash On) for daylight synchro flash (page 37), or adjust EV shift to the + side (page 46).
Night shots come out bad.	Use the following BEST SHOT scenes (page 52) when shooting at night. <ul style="list-style-type: none"> <li>• Night Scene (for shooting night scenery only)</li> <li>• Night Scene Portrait (for shooting people against night scenery)</li> </ul>
Subjects are too dark when shooting images in a seashore or ski area.	Sunlight reflected by water, sand, or snow, can cause underexposure of images. Change the flash mode setting to  (Flash On) for daylight synchro flash (page 37), or adjust EV shift to the + side (page 46).
Digital zoom (including HD zoom and Single SR Zoom) does not work. The zoom bar indicates zoom only up to a zoom factor of 10.0.	The digital zoom setting may be turned off. Turn on digital zoom (page 63).
The image is out of focus during movie recording.	1) Focusing may not be possible because the subject is outside the focus range. Shoot within the allowable range. 2) The lens may be dirty. Clean the lens (page 158).

Problem	Possible Cause and Recommended Action
<b>Playback</b>	
The color of the playback image is different from what appears on the monitor screen when shooting.	Sunlight or light from another source may be shining directly into the lens when you are shooting. Position the camera so sunlight does not shine directly into the lens.
Images are not displayed.	This camera cannot display non-DCF images recorded onto a memory card using another digital camera.
Images cannot be edited (with resizing, trimming, date/time editing, rotation).	<p>Note that you cannot edit the following types of snapshots.</p> <ul style="list-style-type: none"> <li>• Snapshots created using MOTION PRINT</li> <li>• Movies</li> <li>• Snapshots recorded with another camera</li> </ul>
<b>File Deletion</b>	
A file cannot be deleted.	<ol style="list-style-type: none"> <li>1) The file may be protected. Unprotect the file (page 87).</li> <li>2) "🔒 Disabled" setting may be "On". Change the setting to "Off" (page 149).</li> </ol>
<b>Hybrid-GPS</b>	
I can't receive GPS waves.	<ol style="list-style-type: none"> <li>1) "Off" may be selected for the "GPS" setting. Change the "GPS" setting to "On" (page 92). Note that positioning may sometimes take a number of minutes to complete.</li> <li>2) You are indoors, near buildings, or in some other environment where the camera is unable to receive waves from GPS satellites. In outdoor area where there is an unobstructed path to the sky, point the camera's GPS antenna upwards toward the sky and hold it still so it can receive waves.</li> <li>3) The camera stops receiving GPS waves after you turn it off and stop moving it. Turn on the camera.</li> <li>4) GPS sensitivity will be reduced when there is a nearby device transmitting or receiving strong radio waves. Move the camera away from the device causing the problem.</li> <li>5) GPS waves cannot pass through some types of glass. If you suspect that such glass between the camera and the sky may be causing the problem, move to another location where there is no glass.</li> </ol>

Problem	Possible Cause and Recommended Action
Positioning takes a long time.	<ol style="list-style-type: none"> <li>1)The first positioning operation you perform with the camera after you purchase it, immediately after changing the “GPS” setting from “Off” to “On”, or after not using it for a long time may take a number of minutes to complete.</li> <li>2)Normally, a positioning operation should take around 10 seconds. However, changes in the positions of the GPS satellites, as well as the shooting location and environment can cause it to take longer.</li> <li>3)Positioning may take longer than normal in environments where GPS satellite wave reception is poor (page 97).</li> </ol>
The position reading is off.	<ol style="list-style-type: none"> <li>1)Depending on wave conditions, GPS satellite positioning is subject to error of hundreds of meters.</li> <li>2)Performing positioning in an environment where it is difficult to receive GPS satellite waves and where the motion sensor is being influenced by magnetism can result in large errors in positioning readings.</li> <li>3)Performing positioning for a long time with the motion sensor in an environment where it is difficult to receive GPS satellite waves can cause large errors in the positioning readings.</li> </ol>
There is large error in direction information.	<ol style="list-style-type: none"> <li>1)The camera may be being affected by magnetism. Perform direction sensor accuracy adjustment (page 106). Also, move the camera away from sources of magnetism and from metal.</li> <li>2)The direction sensor may not be able to perform direction measurements under any of the following conditions. <ul style="list-style-type: none"> <li>• Immediately after “On” is selected for the “GPS” setting (page 92)</li> <li>• Immediately after loading the battery and turning on the camera</li> </ul> </li> </ol>
The place name is different from the location where I shoot an image.	This can happen immediate after you turn on the camera, when the GPS wave condition icon (page 93) shows  (wave condition poor), or when there are major differences between you current location and the place name data stored in camera memory. If this happens, select “- - -” (blank) for the place name (page 94).
No place name appears on the camera screen.	<ol style="list-style-type: none"> <li>1)There may not be a landmark near your current location.</li> <li>2)There may not be a name in the camera’s built-in place name data in the vicinity of your current location. This will be indicated by “- - -” (blank) appearing on the screen in place of place name candidates (page 95).</li> </ol>

Problem	Possible Cause and Recommended Action
<b>Other</b>	
The wrong date and time are displayed, or the wrong date and time are being stored along with image data.	The date and time setting is off. Set the correct date and time (page 146).
The messages on the display are in the wrong language.	The wrong display language is selected. Change the display language setting (page 147).
Images cannot be transferred over a USB connection.	<ol style="list-style-type: none"> <li>1)The USB cable may not be connected securely. Check all connections.</li> <li>2)The wrong USB communication protocol is selected. Select the correct USB communication protocol in accordance with the type of device you are connecting (pages 122, 131).</li> <li>3)If the camera is not turned on, turn it on.</li> <li>4)Your computer may not be able to recognize the camera if you connect via a USB hub. Always connect directly to the computer's USB port.</li> </ol>
Language selection screen appears when the camera is turned on.	<ol style="list-style-type: none"> <li>1)You did not configure initial settings after purchasing the camera or the camera may have been left with a dead battery. Check the camera setup (pages 20, 147).</li> <li>2)There may be a problem with the camera's memory data. If this is the case, perform the reset operation to initialize the camera's setup (page 151). After that, configure each setting. If the language selection screen does not re-appear when you turn the camera on, it means that the camera's memory management data has been restored. If the same message appears after you turn power back on, contact your retailer or a CASIO authorized service center.</li> </ol>

Problem	Possible Cause and Recommended Action
The time and date settings configured the first time after purchasing the camera are reset to their factory defaults when remove the camera's battery.	Load the camera's battery and reconfigure the time and date settings (page 20). Do not remove the battery from the camera for at least 24 hours after configuring time and date settings. After that, the settings will not be reset if you remove the battery. <ul style="list-style-type: none"> <li>If the time and date are reset to their factory default settings when you remove the battery after it has been loaded for more than 24 hours, it could mean that the camera's setting memory is defective. Contact your retailer or a CASIO authorized service center.</li> </ul>
Buttons are not responsive right after the power has been turned on.	With large capacity memory cards there is a delay after the power has been turned on before the buttons become responsive.

## Display Messages

<b>ALERT</b>	The camera's protection function may have activated because camera temperature is too high. Turn off the camera and wait until it cools down before trying to use it again.
<b>Battery is low.</b>	Battery power is low.
<b>Cannot find the file.</b>	The image you specified with the slideshow "Images" setting cannot be found. Change the "Images" setting (page 80) and try again.
<b>Cannot register any more files.</b>	You are attempting to save a user BEST SHOT scene in the "SCENE" folder when the folder already contains 999 user scenes (page 54).
<b>Card ERROR</b>	There is something wrong with the memory card. Turn off the camera, remove the memory card and then reload it into the camera. If this message re-appears when you turn the camera back on, format the memory card (page 151). <p> <b>IMPORTANT!</b></p> <ul style="list-style-type: none"> <li>Formatting a memory card deletes all its files. Before formatting, try transferring recoverable files to a computer or some other storage device.</li> </ul>
<b>Check connections!</b>	You are attempting to connect the camera to a printer while the camera's USB settings are not compatible with the USB system of the printer (page 115).
<b>Files could not be saved because battery is low.</b>	Battery power is low, so an image file could not be saved.



<b>Folder cannot be created.</b>	You are trying to record a file while there are already 9999 files stored in the 999th folder. If you want to record more, delete files you no longer need (page 31).
<b>Images are being transferred. Stop transfer and turn off power?</b>	You are attempting to turn off power while image data is being transferred using the Eye-Fi card (page 135).
<b>LENS ERROR</b>	This message appears and the camera turns off whenever lens performs some unexpected operation. If the same message appears after you turn power back on, contact a CASIO authorized service center or your original retailer.
<b>LENS ERROR 2</b>	The Camera Shake unit may be malfunctioning. If the same message appears after you turn power back on, contact your retailer or a CASIO authorized service center.
<b>Load paper!</b>	The printer ran out of paper while printing.
<b>Memory Full</b>	Memory is full with images you recorded and/or files saved by editing operations. Delete files you no longer need (page 31).
<b>Printing Error</b>	An error occurred while printing. <ul style="list-style-type: none"> <li>• The printer is turned off.</li> <li>• The printer generated an error, etc.</li> </ul>
<b>Record Error</b>	Image compression could not be performed for some reason during image data storage. Shoot the image again.
<b>RETRY POWER ON</b>	The lens came into contact with an obstruction while moving. The camera will turn off automatically when this message appears. Remove the obstruction and turn power back on again.
<b>SYSTEM ERROR</b>	Your camera system is corrupted. Contact your retailer or a CASIO authorized service center.
<b>The card is locked.</b>	The LOCK switch of the SD, SDHC, or SDXC memory card loaded in the camera is in the locked position. You cannot store images to or delete images from a memory card that is locked. <div style="float: right; text-align: center;"> <p>LOCK</p>  </div>
<b>There are no files.</b>	There are no files in built-in memory or on the memory card.
<b>There are no printing images. Set up DPOF.</b>	There are currently no files specified for printing. Configure the required DPOF settings (page 117).
<b>There is no image to register.</b>	The setup you are trying to save is for an image that cannot be saved as a user BEST SHOT scene.

<b>This card is not formatted.</b>	The memory card loaded in the camera is not formatted. Format the memory card (page 151).
<b>This file cannot be played.</b>	The file you are trying to access is corrupted or is a type that cannot be displayed by this camera.
<b>This function cannot be used.</b>	This message will appear part way through an operation when you attempt to use a function that is not allowed in combination with another function.

## Number of Snapshots/Movie Recording Time

### Snapshot

Image Size (Pixels)	Image Quality	Approximate Image File Size	Built-in Memory (Approx. 14.5MB*1) Snapshot Recording Capacity	SD Memory Card (1GB*2) Snapshot Recording Capacity
14M (4320×3240)	Fine	9.31 MB	1	103
	Normal	4.86 MB	3	199
3:2 (4320×2880)	Fine	8.19 MB	1	118
	Normal	4.29 MB	3	225
16:9 (4320×2432)	Fine	6.78 MB	2	142
	Normal	3.57 MB	4	270
10M (3648×2736)	Fine	6.4 MB	2	151
	Normal	3.38 MB	4	286
6M (2816×2112)	Fine	3.48 MB	4	277
	Normal	1.89 MB	7	511
3M (2048×1536)	Fine	2.0 MB	7	483
	Normal	1.25 MB	11	773
VGA (640×480)	Fine	430 KB	34	2249
	Normal	290 KB	50	3335

## Movies

Image Quality (Pixels)	Maximum File Size	Approximate Data Rate (Frame Rate)	Built-in Memory (Approx. 14.5MB*1) Movie Recording Capacity	SD Memory Card (1GB*2) Movie Recording Capacity	File Size of 1-minute Movie
HD 1280×720	Maximum Movie Size: 4 GB	10.9 Megabits/second (30 frames/second)	11 seconds	12 minutes 10 seconds	81.8 MB
STD 640×480		3.8 Megabits/second (30 frames/second)	32 seconds	35 minutes 18 seconds	28.5 MB

\*1 Built-in memory capacity after formatting

\*2 The above values are based on use of a PRO HIGH SPEED SD memory card (Panasonic Corporation). The number of images you can save depends on the type of memory card you are using.

- Snapshot and movie recording capacity values are approximate and intended for reference only. Actual capacity depends on image contents.
- File size and data rate values are approximate and intended for reference only. Actual values depend on the type of image being shot.
- When using a memory card with a different capacity, calculate the number of images as a percentage of 1GB.
- A single movie shoot with the "For YouTube" scene can have a maximum file size of 2048MB or a recording time of up to 15 minutes.

## Specifications

<b>File Format</b>	Snapshots: JPEG (Exif Version 2.3); DCF 2.0 standard; DPOF compliant Movies: MOV format, H.264/AVC standard, IMA-ADPCM (monaural)
<b>Recording Media</b>	Built-in Memory (Image Storage Area: 14.5MB*) SD/SDHC/SDXC * Built-in memory capacity after formatting
<b>Recorded Image Sizes</b>	Snapshot: 14M (4320×3240), 3:2 (4320×2880), 16:9 (4320×2432), 10M (3648×2736), 6M (2816×2112), 3M (2048×1536), VGA (640×480) Movies: HD (1280×720), STD (640×480)
<b>Image Deletion</b>	1 file; selected files; all files (with memory protection feature)
<b>Effective Pixels</b>	14.10 Megapixels
<b>Imaging Element</b>	Size: 1/2.3-inch square pixel CCD Total Pixels: 14.48 Megapixels
<b>Lens/Focal Distance</b>	F3.2 (W) to 5.7 (T) f= 4.3 to 43.0 mm (equivalent to 24 to 240 mm in 35 mm format) Eleven lenses in ten groups, including aspherical lens.
<b>Zoom</b>	10X Optical zoom, 15X in combination with Single SR Zoom 4X Digital zoom Up to 159.4X when HD Zoom and Digital zoom are used in combination (VGA size)
<b>Focusing</b>	Contrast Detection Auto Focus • Focus Modes: Auto Focus, Macro Focus, Super Macro Focus, Infinity, Manual Focus • AF Area: Intelligent, Spot, Multi, Tracking; with AF assist lamp
<b>Approximate Focus (Snapshot) (From Lens Surface)</b>	Auto Focus: 15 cm to ∞ (5.9" to ∞) (Wide Angle) Macro Focus: 7 cm to 50 cm (2.8" to 19.7") (First step zoom from the Widest Angle setting) Super Macro Focus: 7 cm to 50 cm (2.8" to 19.7") Infinity: ∞ Manual: 15 cm to ∞ (5.9" to ∞) (Wide Angle) * Range is affected by optical zoom.
<b>Metering</b>	Multi-pattern, center weighted, and spot by imaging element
<b>Exposure Control</b>	Program AE
<b>Exposure Compensation</b>	-2.0 EV to +2.0 EV (in 1/3EV steps)

<b>Shutter</b>	CCD shutter, mechanical shutter
<b>Shutter Speed</b>	Snapshot (Auto): 1/2 to 1/2000 second Snapshot (Night Scene): 4 to 1/2000 second * May differ due to the camera setup.
<b>Aperture Value</b>	F3.2 (W) to F7.5 (W) (When used with ND filter) * Using optical zoom changes the aperture value.
<b>White Balance</b>	Auto, Daylight, Overcast, Shade, Day White Fluorescent, Daylight Fluorescent, Tungsten, Manual WB
<b>Sensitivity (Standard Output Sensitivity, Recommended Exposure Index)</b>	Snapshots: Auto, ISO 80, ISO 100, ISO 200, ISO 400, ISO 800, ISO 1600, ISO 3200 equivalent Movies: Auto
<b>Self-timer</b>	Approximate Trigger Times: 10 seconds, 2 seconds, Triple Self-timer
<b>Flash Modes</b>	Auto, Off, On, Soft, Red-eye reduction
<b>Flash Range (ISO Sensitivity: Auto)</b>	0.2 m to 3.5 m (0.7' to 11.5') (Wide Angle) 0.5 m to 1.9 m (1.6' to 6.2') (Telephoto) * Range is affected by optical zoom.
<b>Flash Charging Time</b>	Approximately 5 seconds maximum
<b>Recording</b>	Snapshots (Auto/Premium Auto); Single SR Quality; Single SR Zoom; Macro; Self-timer; BEST SHOT; Slide Panorama; Make-up; Landscape; Face Detection; Dynamic Photo; Movies (HD movie and For YouTube) (with monaural audio); Snapshots and Movies with location information (latitude and longitude, camera aiming direction, place name); Place Name Stamping
<b>Monitor Screen</b>	3.0-inch TFT color LCD (Super Clear LCD) 460,800 (960×480) dots
<b>Viewfinder</b>	Monitor Screen
<b>Timekeeping Function</b>	Built-in quartz digital clock Date and Time: Recorded with image data Auto Calendar: To 2049 Auto time adjustment (base on GPS information)
<b>World Time</b>	162 cities in 32 time zones City name, date, time, summer time Auto time adjustment (base on GPS information)
<b>External connection terminal</b>	USB port (Hi-Speed USB compatible) / AV output terminal (NTSC/PAL) HDMI output (Mini)
<b>Microphone</b>	Monaural
<b>Speaker</b>	Monaural
<b>Power Requirements</b>	Rechargeable lithium ion battery (NP-90) ×1

## Approximate Battery Life

All of the values provided below represent the approximate amount of time under normal temperature (23°C (73°F)) before the camera turns off. These values are not guaranteed. Low temperatures shorten battery life.

<b>Number of Shots (CIPA) (Operating Time)*<sup>1</sup></b>	600 shots
<b>Continuous Playback (Snapshots)*<sup>2</sup></b>	5 hours 40 minutes
<b>Approximate continuous movie recording time*<sup>3</sup></b>	3 hours 20 minutes

- Battery: NP-90 (Rated Capacity: 1950 mAh)
- Recording Medium: 1GB SD memory card (PRO HIGH SPEED (Panasonic Corporation))
- Measurement Conditions

\*<sup>1</sup> Approximate number of shots (CIPA) (Operating Time)

In accordance with CIPA (Camera and Imaging Products Association) standards Normal temperature (23°C (73°F)), monitor on, zoom operation between full wide and full telephoto every 30 seconds, during which two images are shot with flash; power turned off and back on every time 10 images are shot.

\*<sup>2</sup> Approximate playback time

Standard temperature (23°C (73°F)), one-image scroll approximately every 10 seconds

\*<sup>3</sup> Approximate time using a 16GB SDHC memory card for a repeated cycle of 10 minutes recording followed by deletion of the recorded file.

- The above values are based a new battery, starting from a full charge. Repeated charging shortens battery life.
- Frequency of flash, zoom, Auto Focus, and GPS usage, and the time the camera is on greatly affects recording time and number of shots values.

<b>Power Consumption</b>	3.7 V DC, Approximately 3.6 W
<b>Dimensions</b>	102.5 (W) × 67.5 (H) × 28.8 (D) mm (4.0" (W) × 2.7" (H) × 1.13" (D)) (24.7 mm (0.97") thick excluding projections)
<b>Weight</b>	216g (7.6 oz) (including battery and memory card) 172g (6.1 oz) (excluding battery and memory card)

## ■ Rechargeable lithium ion battery (NP-90)

<b>Rated Voltage</b>	3.7 V
<b>Rated Capacitance</b>	1950 mAh
<b>Operating Temperature Requirement</b>	0 to 40°C (32 to 104°F)
<b>Dimensions</b>	34.0 (W) × 52.3 (H) × 10.9 (D) mm (1.34" (W) × 2.06" (H) × 0.43" (D)) (excluding projections)
<b>Weight</b>	Approximately 42 g (1.5 oz)

## ■ Charger unit (BC-90L)

<b>Input Power</b>	100 to 240 V AC, 200 mA, 50/60 Hz
<b>Output Power</b>	4.2 V DC, 1000 mA
<b>Operating Temperature Requirement</b>	5 to 35°C (41 to 95°F)
<b>Supported Battery Type</b>	Rechargeable lithium ion battery (NP-90)
<b>Charging Time</b>	200 minutes
<b>Dimensions</b>	57 (W) × 24 (H) × 96 (D) mm (2.2" (W) × 0.94" (H) × 3.8" (D)) (excluding projections)
<b>Weight</b>	Approximately 70 g (2.5 oz)

- Power cord precautions for use in Singapore  
The power cord set is not supplied. The power cord used must comply with relevant national and/or international standards.



**CASIO®**

**CASIO COMPUTER CO.,LTD.**  
6-2, Hon-machi 1-chome  
Shibuya-ku, Tokyo 151-8543, Japan

# Dynamic Photo™

## Getting the Most Out of Dynamic Photo

Dynamic Photo  
Special Site

For a wealth of information about Dynamic Photo including explanations about how to use Dynamic Photo images, the Dynamic Studio image conversion service, sample images, and more, visit the special Dynamic Photo website at:

<http://dp.exilim.com/>

This manual provides an introduction to Dynamic Photo, which creates a whole new way to enjoy digital imaging.

- All screen shots shown in this manual are in English. However, the camera allows you to select another display language, if you want.

### Contents

<b>Dynamic Photo! A totally new way to enjoy digital photography!</b> .....	<b>2</b>
<b>Creating a Dynamic Photo Image</b> .....	<b>3</b>
Step 1: Shoot the image into which you want to insert an built-in subject .....	3
Step 2: Create the Dynamic Photo image. ....	3
Step 3: Have fun with Dynamic Photo. ....	6
Step 4: Converting a Dynamic Photo Still Image to a Movie (Movie Converter).....	6
Step 5: Use Dynamic Studio to expand use of Dynamic Photo images to other applications. ..	7

# Dynamic Photo! A totally new way to enjoy digital photography!

Dynamic Photo provides an easy way to insert built-in subjects into snapshots and movies for a whole new way to enjoy digital imaging.

You can create a Dynamic Photo image by inserting a built-in moving subject into a background image (snapshot or movie). Before performing the following steps, you should record the background image (snapshot or movie) into which you want to insert the moving subject.

- The term “built-in subjects” refers to the moving figures and characters that came pre-programmed in the camera’s built-in memory.

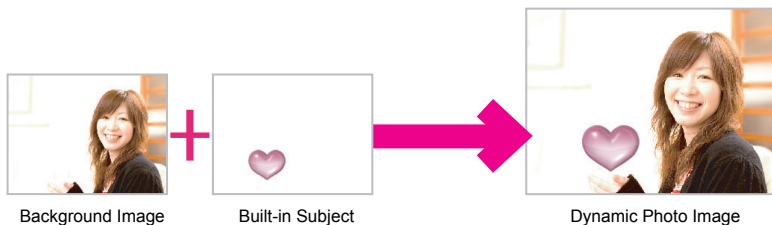

# Creating a Dynamic Photo Image

Your digital camera comes with a number of subjects in its built-in memory (“built-in subjects”). You can use these built-in subjects to create Dynamic Photo images by inserting them into your original snapshots or movies.

## Step 1: Shoot the image into which you want to insert a built-in subject.

### 1. Remove the memory card from the camera (if one is loaded).

You will not be able to access the built-in subjects while a memory card is loaded in the camera.

### 2. In the REC mode, compose the image and press the shutter button to shoot a standard snapshot.

You will insert the built-in subject into the snapshot you shoot here.



## Step 2: Create the Dynamic Photo image.

Now simply insert a built-in subject into the snapshot or movie you shot in step 1 to create your own original Dynamic Photo image.

### 1. Press [▶] to enter the PLAY mode.

### 2. Perform the following operation on the camera [MENU] → PLAY tab → “Dynamic Photo”.



### 3. Use [◀] and [▶] to select the background image you want and then press [SET].

Select the image you want to use as the background. Here, select the image you recorded in step 1 of this procedure.

- \* Only images that are able to be used as background images will appear for selection at this time.
- Only an image that satisfies the following conditions can be used as a background image.
  - A snapshot or movie recorded with this camera or a snapshot transferred to this camera’s memory using Photo Transport
  - A snapshot with an aspect ratio of 4:3



4. Use [◀] and [▶] to select the built-in subject that you want to insert into the image and then press [SET].

\* Only built-in subjects that can be inserted into other images will appear at this time.

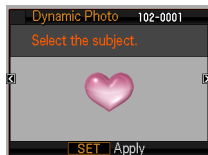

5. If you are inserting a subject into a movie an image will appear on the monitor screen showing the approximate location of the subject in the movie. Use [◀] and [▶] to shift the location to the position you want. After you are finished, press [SET].

- If you insert a subject into a movie, the resulting movie will be a maximum of 20 seconds long. Everything before and after the insertion is cut off. If the movie you are inserting into (original movie) is shorter than 20 seconds, the resulting movie will be the same length as the original movie.
- If you are inserting a subject into a snapshot, skip directly to step 6.

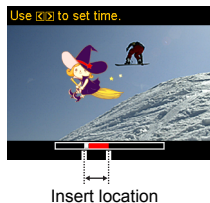

6. Use the zoom controller to adjust the size of the subject and use [▲], [▼], [◀], and [▶] to adjust its position. When everything is the way you want, press [SET].

This inserts the subject into another image and creates a Dynamic Photo.



7. After creation of the Dynamic Photo image is complete, the finished image will appear on the monitor screen.



## Complete!

- Inserting a built-in subject into a snapshot will save a Dynamic Photo that consists of 20 still images of 2M size or smaller.
- Inserting a built-in subject into a movie will save the Dynamic Photo as a movie file.

## Important!

- You will not be able to access the built-in subjects while a memory card is loaded in the camera. If you want to use the built-in subjects while a memory card is loaded in the camera, use the “Built-in → Card” copy operation to copy the built-in subjects from built-in camera memory to the memory card.
- Performing a delete or format operation will not delete the built-in subjects.

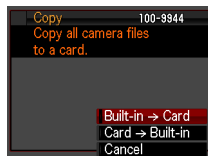

## Step 3: Have fun with Dynamic Photo.

You can use the Dynamic Photo image you created in Step 2 in a variety of fun ways.



### On the camera

Dynamic Photo images play back automatically as soon as you display them on the EXILIM monitor screen.



### On a TV

Connect your EXILIM to a TV with the AV cable and you can enjoy watching Dynamic Photo images on your TV screen.



## Step 4: Converting a Dynamic Photo Still Image to a Movie (Movie Converter).

A Dynamic Photo with a still image background and a moving subject is stored as a series of 20 still images. You can use the following procedure to convert the 20 images that make up a Dynamic Photo to a movie.

1. Press [▶] to enter the **PLAY** mode.
2. Use [◀] and [▶] to display the Dynamic Photo you want to convert.
3. Perform the following operation on the camera [MENU] → **PLAY** tab → “Movie Converter”.



4. Press [SET] to convert the displayed Dynamic Photo.
  - The final movie format is H.264.
  - The final movie image size is 640×480 pixels.
5. Save the converted Dynamic Photo to your computer.

## Step 5: Use Dynamic Studio to expand use of Dynamic Photo images to other applications.

<http://dynamicstudio.jp/>

Using the CASIO EXILIM Dynamic Photo feature to create a Dynamic Photo image with a moving subject produces a CS image that reproduces the movement of the character. Dynamic Studio is a free online service that lets you convert the CS image to a movie file for playback on a PC, digital photo frame, cell phone, or other device. Now you can enjoy your Dynamic Photo images on a virtually unlimited number of different devices.

\* Dynamic Studio service availability and content are subject to change without notice.

### Dynamic Studio

*Dynamic Photo Data Conversion Service*

#### On a PC

Enjoy watching Dynamic Photo images on your PC screen.



#### In a digital photo frame

Play Dynamic Photo images in a digital photo frame.



#### On a cell phone

View Dynamic Photo images on your cell phone screen.

#### Share with your friends

Send the Dynamic Studio URL to your friends and share your Dynamic Photo creations with them.



#### e-Greeting Cards

Send animated e-greeting cards to your special friends and family members.

#### For presentations

Animation GIF files can be included in presentation data for an impression that really lasts.

