

BENQ-SIEMENS P51
PDA Phone
User Guide

Sidebar Signs



Text set off in this manner indicates a note. A note will elaborate the current topic with further information or mention something a little off topic.



Text set off in this manner indicates a warning. Failure to follow the said warning could result in damage to equipment or loss of information.



Text set off in this manner indicates a tip. A tip will recommend an action which helps you better use the product.

Safety Precautions

Information for parents

Please read the operating instructions and safety precautions carefully before use. Explain the content to your children and the hazards associated with using the phone.



Remember to comply with legal requirements and local restrictions when using the phone. For example, in aeroplanes, petrol stations, hospitals or while driving.



Mobile phones can interfere with the functioning of medical devices such as hearing aids or pacemakers. Keep at least 20 cm/9 inches between phone and pacemaker. When using the mobile phone hold it to the ear which is furthest away from the pacemaker. For more information consult your doctor.



Always keep the phone and accessories out of reach of small children.

Small parts such as the SIM card, dust cap, lens ring and lens cap as well as the SD Card can be dismantled and swallowed by small children.



Do not place the phone near to electromagnetic data carriers such as credit cards and floppy disks. Information stored on them could be lost.



Do not look directly into the LED (e.g. flash LED) with optical magnifiers because of radiation.



Permanent hearing loss may occur if you use ear- or headphones at high volume. You can adapt over time to a higher volume, which may sound normal but can be damaging to your hearing. Set your volume to a safe level. If you experience discomfort or buzzing in your ears, reduce the volume or discontinue use of your ear- or headphones.



Ringtones, info tones and handsfree talking are reproduced through the loudspeaker. Do not hold the phone to the ear when it rings or when you have switched on the handsfree function. Otherwise you risk serious permanent damage to your hearing.



The mains voltage (V) specified on the power supply unit must not be exceeded. Otherwise the charging device may be damaged.

The power supply must be plugged into an easily accessible AC mains power socket when charging the battery. The only way to turn off the charging device after charging the battery is to unplug it.



You may only open the phone to replace the battery, SIM and SD Card. You must not open the battery under any circumstances. All other changes to this device are strictly prohibited and will invalidate the guarantee.



- Only use original batteries and charging devices. Otherwise you risk serious damage to health and property. The battery could explode, for instance.
- All batteries can cause property damage, injury or burns if a conductive material such as jewelry, keys or beaded chains touch exposed terminals. The material may complete an electrical circuit and become quite hot. Exercise care in handling any charged battery, particularly when placing it inside your pocket, purse or other container with metal objects. Your batteries are supplied with a protective cover. Please attach this cover to your batteries when detached from the phone and not in use.
- Do not dispose of batteries in fire as they may explode.



The phone may cause interference in the vicinity of TV sets, radios and PCs.



Use only original accessories. This will avoid potential risks to health or property and ensure compliance with all relevant regulations.



All electrical and electronic products should be disposed of separately from the household waste via designated collection facilities appointed by the government or the local authorities.

This crossed-out wheellie bin symbol on the product means the product is covered by the European Directive 2002/96/EC.

The correct disposal and separate collection of your old appliance will help prevent potential negative consequences for the environment and human health. It is a precondition for re-use and recycling of used electrical and electronic equipment.

For more detailed information about disposal of your old appliance, please contact your local council, waste disposal service or the shop where you purchased the product.

Improper use will invalidate the guarantee! These safety instructions also apply to original accessories.

Bluetooth®

Your phone has a Bluetooth interface. This makes it possible to establish a wireless connection with your phone and a headset of a car kit, or other Bluetooth-enabled devices.

In order to establish a secure link between the devices and to prevent a third party from having access to your phone, you should observe the following points:

- The initial connection between two devices, what is called "pairing", should take place in familiar surroundings.
- Both devices must be able to identify themselves one time by using a password/PIN. To ensure sufficient security, you should choose a 16-digit number

combination for a password that would be difficult to guess (if a PIN has not been assigned).

- An automatic connection acceptance ("connection without confirmation") should only be used in exceptional cases.
- In general, only trustworthy devices should be linked in order to minimize security risks.
- You should restrict the "visibility" of your phone if possible. This will make it much more difficult for unknown devices to establish a connection with your phone. To do this, in the Wireless Manager window, tap Menu > Bluetooth Settings and uncheck the "Make this device discoverable to other devices" option.
- The name of your phone is transmitted in a Bluetooth connection. The factory default name is "Pocket_PC". The first time Bluetooth is activated, or later in the Bluetooth menu, you can change this name by tapping Start > Settings > Owner Information.
- If Bluetooth is not needed, this function should be deactivated.

Before using Bluetooth accessories, or a mobile phone inside a vehicle, check the vehicle user guide for any limitations on the use of these products.

Table of Contents

Safety Precautions	ii
Introduction	1
Phone exterior	2
Front view.....	2
Description of the indicators	4
Top view and bottom view	5
Left-side view and right-side view.....	6
Rear view	7
Hardware setup	8
SIM card installation.....	8
Battery installation	10
Removing the battery.....	11
Battery charging	12
Startup	13
First-time startup	13
Using the stylus	14
Sleep mode	14
Deep sleep mode.....	14
Soft reset	15
Hard reset	15
Clean boot	16

Today screen.....	17
Today screen	17
Navigation bar.....	18
Start button	19
Menu bar	20
Input methods.....	21
Entering typed text.....	21
Using the QWERTY keyboard	21
Using the Input Panel	22
<i>Virtual keyboard</i>	22
<i>Letter Recognizer</i>	23
<i>Block Recognizer</i>	23
<i>Transcriber</i>	23
Writing on the screen.....	24
Selecting a sentence.....	24
Converting writing to text	25
Drawing on the screen	26
Creating a drawing.....	26
Selecting a drawing	26
Settings.....	27
Personal settings	27
Buttons	27
Input	28
Lock	28
Menus	28
MSN Options	28
Owner Information	28
Phone.....	29
Sounds & Notifications.....	29
Speech Commander Settings.....	30

Today.....	30
System settings	31
About.....	31
Self Test	31
Backlight.....	31
Certificates.....	32
Clocks & Alarms	32
Device Info	33
Error Reporting.....	33
GPS.....	33
Memory.....	33
Power.....	34
Regional Settings.....	34
Remove Programs.....	35
Screen	35
Connections settings.....	35
Beam.....	35
Bluetooth®	35
<i>Setting up Bluetooth®</i>	36
<i>Using a Bluetooth® stereo headset</i>	37
Connection Settings.....	37
Connections	38
<i>Setting up a GPRS and CSD connection to your ISP</i>	39
<i>Configuring proxy server settings</i>	41
<i>Setting up a VPN connection to your corporate network</i>	42
<i>GPRS Authentication</i>	43
<i>Using WLAN</i>	43
Network Cards - connecting to an existing wireless network	43
<i>Adding a new wireless network</i>	44
<i>Searching for wireless networks to access</i>	44
USB to PC	44
Wireless Manager	44

Cell Broadcast.....	44
Phone operation.....	45
Phone screen.....	45
Making and receiving phone calls.....	45
Making a call directly.....	45
Answering a call.....	46
Ending a call.....	46
Making a call from Contacts.....	46
Making a speed dial call.....	47
<i>Making a speed dial call.....</i>	<i>47</i>
Making a conference call.....	47
Loudspeaker.....	48
Associating notes with calls.....	49
Viewing past phone activity.....	49
Flight mode.....	50
Programs.....	51
Calendar.....	53
Contacts.....	54
Internet Explorer.....	54
Messaging.....	54
<i>Setting up an MMS connection.....</i>	<i>55</i>
Windows Media.....	55
Help.....	56
Games.....	56
Mobile Security.....	56
Calculator.....	56
Speech Commander.....	56
Download Agent.....	56
Excel Mobile.....	57

File Explorer	57
Java Manager	57
Modem Link.....	58
Notes.....	58
Pictures & Videos.....	58
Pocket MSN.....	58
PowerPoint Mobile	58
Search.....	59
Set Ringtone	59
SIM Message.....	59
SIM Toolkit	59
Skype.....	60
Sprite Backup	60
Tasks	60
Terminal Services Client.....	60
Digital Media Server	61
Word Mobile	61
Recover Storage.....	61
SIM Upload	61
Digital Media Control Point.....	61
Camera/camcorder operation	62
Taking photographs	62
Standard capture mode	63
Colour options	64
Recording videos.....	65
Shooting videos	66
Browsing and opening image, video or music files.....	66
Viewing images	67
Viewing videos or playing music	67

Editing an image file with Pocket Edit	69
Options in Pocket Edit	70
Microsoft ActiveSync	71
Installing ActiveSync on PC.....	71
Setting up a sync relationship	71
Adding programs.....	72
Removing programs.....	73
Push Mail	73
Connect to ActiveSync using Bluetooth®	74
Webaroo	76
Installing Webaroo	76
Running Webaroo.....	77
Troubleshooting information	78
Call-related problems.....	78
Message problems	80
Internet problems.....	80
Connection problems	80
System problems	81
Battery charging problems.....	81
ActiveSync problems.....	82
Care and maintenance	83
Customer Care	84
Product data	86

SAR.....	87
Guarantee certificate (UK)	88
Guarantee certificate (IRL)	89
License Agreement	90

Introduction

Thank you for purchasing this BenQ-Siemens PDA phone. This user guide provides important procedures and information to familiarise yourself with the device. Please keep this guide in a safe place for future reference.

Phone exterior

Front view

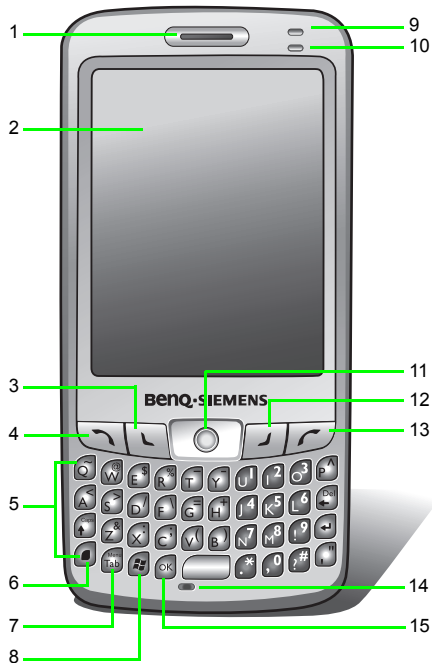



No.	Name	Description
1	Ear piece	Listen here during a phone call.
2	LCD touchscreen	- Shows the screen display. - You can tap and write on the touchscreen.
3	Left soft key	Runs a command as instructed by the screen.
4	Send key	- Press to pick up incoming calls. - Press to bring up Dial screen. - Press to place a call after dialling. - Long press to activate/deactivate loudspeaker.
5	QWERTY keyboard	Type text and enter numbers here.
6	Function key	-
7	Tab key	-
8	Start key	-
9	Power indicator	See "Description of the indicators" on page 4 for more information.
10	Connection indicator	See "Description of the indicators" on page 4 for more information.
11	Joystick	- Shift to move selection highlight in a program. - Press to make a selection.
12	Right soft key	Runs a command as instructed by the screen.
13	End key	- Press to reject incoming calls. - Press to bring up the Today screen.
14	Microphone	-
15	OK or X (Close) key	-

Description of the indicators

Indicator	Colour	Lighting behaviour	Description
Power indicator	Red	Flash	Indicates that a new event (new message, a new missed call, system warning, etc.) occurs (indicated by the appearance of certain icons on the Navigation bar).
		On	Charging in progress.
	Green	Flash	The PDA phone is in standby mode.
		On	Charging is complete.
	Orange	On	The battery is completely drained.
Connection indicator	Green	Flash	Indicates that the WLAN function has been enabled.
	Blue	Flash	Indicates that the Bluetooth® function has been enabled.
	Green/Blue	Alternating flash	Indicates that the WLAN and Bluetooth® functions have both been enabled.

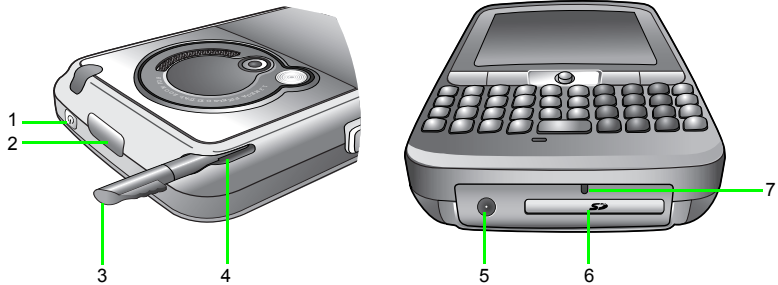
Top view and bottom view



No.	Name	Description
1	Power button	- Press to power off or on (entering or leaving the sleep mode). - Long press to turn the backlight off or on (consuming more power than the sleep mode).
2	GPS antenna	Receives GPS signals. For best quality, make sure the GPS is positioned before driving. Also, always point this antenna to the sky and use the car holder when driving.  Environmental factors (such as a cloudy or rainy day and the window film on a windshield) may significantly reduce the GPS quality when receiving signals.
3	Stylus	Device for tapping and writing on the touchscreen
4	Stylus housing	Storage area for stylus
5	Battery charger socket	Insert the battery charging connector here.
6	SD card slot (expansion slot)	For insertion of an SD memory card (storage card).
7	Reset button	Insert the stylus in to the recess to trigger the reset button.

Left-side view and right-side view

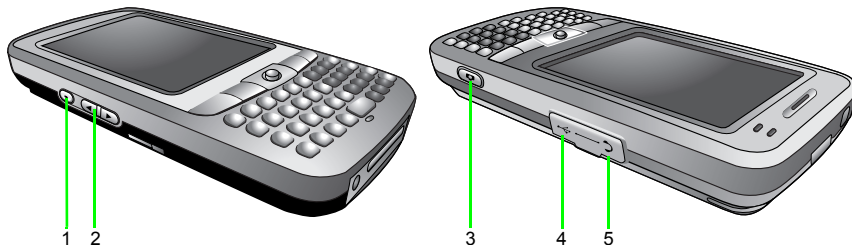

No.	Name	Description
1	Audio recorder button/ Voice commander	- Long press here to record audio. - Short press to use handsfree voice command.
2	Sound level buttons	Press to adjust speech and device volume levels.
3	Camera/Camcorder key	Press to launch Camera/Camcorder.
4	mini-USB socket	Insert a data cable for connecting to another device or charging.
5	Headset jack	Connects to a headset.

Rear view

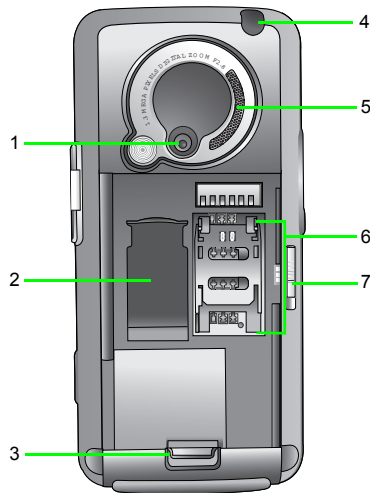

No.	Name	Description
1	Camera lens	Aim camera lens at objects of interest when using camera/camcorder.
2	2nd SIM card storage compartment	Extra storage space available for a second SIM card
3	Battery latch	Press to release battery.
4	External GPS antenna jack	Connects to an external GPS antenna, which is recommended for best GPS performance.
5	Loudspeaker	Plays ringtones and device audio.
6	SIM card socket	Your SIM card installs here.
7	Battery lock	Locks the battery.

Hardware setup

SIM card installation

You can obtain a SIM card from a mobile phone service provider when you sign on as a subscriber. When you insert a SIM card into your PDA phone, you can begin using it to make and receive phone calls. Please follow the instructions below to insert a SIM card into the phone.

1. Locate the SIM card holder.

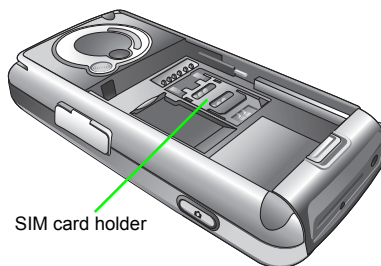

2. Push the SIM card holder in the direction of the arrow (as shown in the figure to the right) to unlock it.

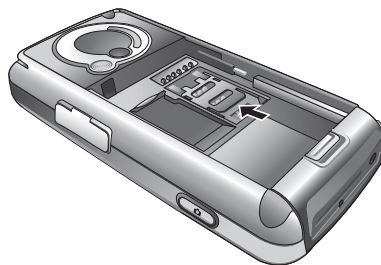

3. Pick up and raise the SIM card holder in an upright position.

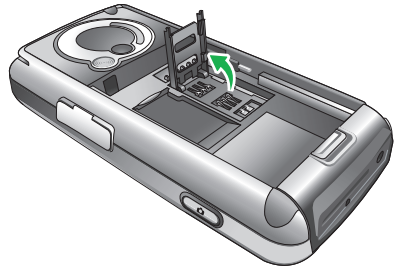

4. Hold the SIM card over the SIM card holder ready for insertion. Make sure you hold the SIM card so that the side with the metal contacts will face down when you close the SIM card holder. (See the figure to the right for reference.)

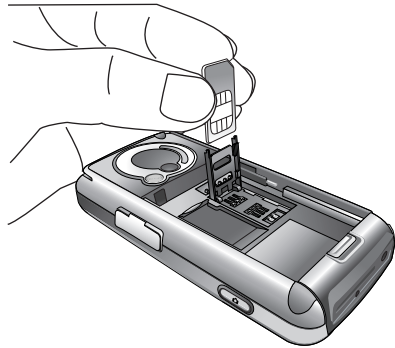

5. Insert the SIM card into the SIM card holder. Make sure it goes in completely.

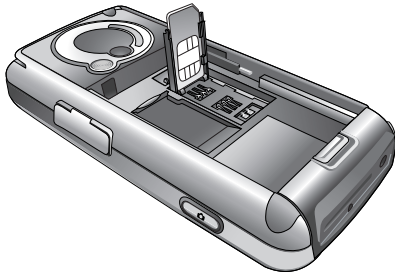

6. Lower the SIM card holder with the SIM card in it to close it. Push the SIM card holder in the direction of the arrow (as shown in the figure to the right) to lock it.

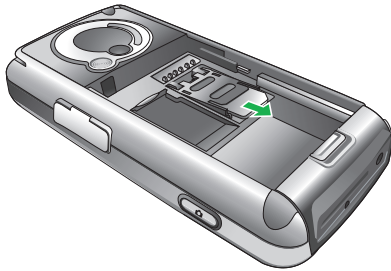

Battery installation

1. The battery goes into the battery compartment in the back of the phone. Slip the battery into the battery compartment top edge first.

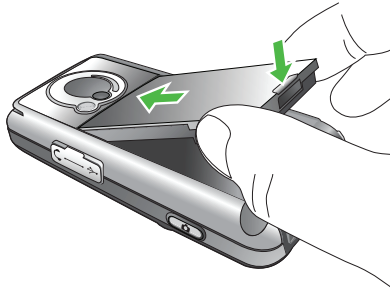

2. With the top half in position, push down the rest of the battery into the compartment. The battery latch will click to secure the battery in place.

3. Slide the battery lock switch to the lock position.

 The battery lock must be in the lock position before the phone can charge or power ON.

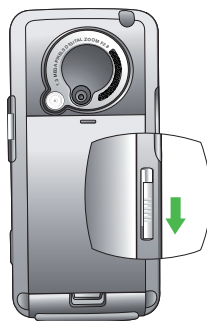

Removing the battery

1. We suggest you to power off the PDA phone before you remove the battery.

2. Slide the battery lock switch to the unlock position and you will hear a beep sound.

 The battery lock switch must be in the unlock position before the battery can be removed.

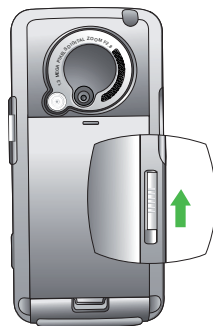

3. Then remove the battery.

Battery charging

1. Connect the one end of the charger cable into the PDA phone and the other into a wall power outlet to begin charging.



2. Disconnect the charger cable when charging is completed.



- Before using the battery for the first time, make sure that it is charged for at least eight hours to prolong its lifetime.

- It takes at least one charging-discharging cycle for the battery to reach its peak performance.

- You can also charge your phone using the USB data cable while it is connected to the PC as an alternative to using the charger cable.



- To avoid possible damage to the battery, please make sure that the battery is unlocked when inserting or removing it.

- Keep the phone in normal room temperature while charging. As a safety precaution, when the phone temperature is above 55 or below 0 degrees Celsius it will automatically stop charging temporarily.



- Do not remove the battery when charging to avoid possible damage.



- Please make sure that the battery lock is set to the lock position while charging.

Startup

First-time startup

After you have installed the battery and finished charging it, you are ready to power ON your PDA phone. The first time you power ON the phone, you will be guided through a series of setup screens. Follow the steps below to start up your phone and complete the initial setup.

1. With the battery lock in the lock position, press **Power** to power ON the phone.
2. Wait for the phone to boot up with the BenQ-Siemens screen.
3. On the Windows Mobile screen, tap the stylus anywhere on the screen to proceed.
4. During the **align screen** process, aim and tap the stylus precisely on the cross-hair object. The cross-hair object will move around the screen several times until the screen is aligned. Each time the cross-hair object moves to a new location, aim and tap it.
5. Select the time zone of your location, and then tap **Next**.
6. The message shows you how the stylus works. You can single tap to select an item/command, or tap and hold (long tap) for a menu (where available). Tap **Next**.
7. Tap and hold the 9 A.M. time slot to bring up a pop-up menu. Select **Cut** from the pop-up menu.
8. Tap and hold the 11 A.M. time slot to bring up a pop-up menu. Select **Paste** from the pop-up menu. Tap **Next** to continue.
9. Tap **Next** to enter a password if you want to protect access to your data and available networks while using the PDA phone. If you do not need the password, tap **Skip**.
10. Tap anywhere on the final screen to exit setup.

Using the stylus

The stylus works like a mouse on a PC. You can use the stylus to point and click various objects on the screen. The following are basic stylus techniques you should learn in order to operate your PDA phone efficiently.

- **Tap** - Touch the screen once with the stylus to open items and select options.
- **Drag** - Hold the stylus on the screen and drag it across the screen to select text and images. Drag in a list to select multiple items.
- **Tap and hold** - Tap and hold the stylus on an item to see a list of actions available for that item. Before a pop-up menu appears, you will see a blue circle of dots to notify you of where on the screen you are pressing. On the pop-up menu that appears, tap the action you want to perform.

Sleep mode

Once the PDA phone is on, you can press **Power** to put it in sleep mode. During sleep mode, the screen shuts off and the system stands by for incoming phone calls or user input. Pressing **Power** will switch ON the phone again.

- ☞ Please note that your PDA phone needs about 5 seconds to finish the booting procedure. If you want to switch the power off right after you power it on, please wait for 5 seconds before powering off your PDA phone.
- The PDA phone will automatically enter sleep mode if it is inactive for 3 minutes. You can also customise the length of inactivity before entering sleep mode.
- See "Backlight" on page 31 and "Power" on page 34 for more on power management.

Deep sleep mode

The PDA phone will go into deep sleep mode under two situations:

1. The battery lock is not in the lock position. In other words, the battery is not locked.
2. The battery capacity is low.

Soft reset

A soft reset restarts the PDA phone but does not erase any data, program, or system settings.

To perform a soft reset:

1. Locate the recessed **Reset** at the bottom of the phone.
2. Insert the stylus into the recess to trigger **Reset**. Hold **Reset** down until the screen fades off.
3. Release the stylus from the Reset button to restart the phone.

Hard reset

As with a soft reset, a hard reset restarts the PDA phone without erasing any data, program, or system settings. But a hard reset also resets the system time to the default value (1 January, 2006).

To perform a hard reset:

1. Locate the recessed **Reset** at the bottom of the phone.
2. Press and hold down **Power**.
3. Without releasing **Power**, insert the stylus into the recess to trigger **Reset**. Hold down both **Power** and **Reset** until the screen fades off.
4. When the screen has faded off completely, release both **Power** and the stylus.

Clean boot

A clean boot restarts the PDA phone by erasing all data and programs as well as system settings, and thus returns to its factory default state.

To perform a clean reset:

1. Locate the recessed **Reset** at the bottom of the PDA phone.
2. Press and hold down **Power**.
3. Without releasing **Power**, insert the stylus into the recess to trigger **Reset**. Hold down both **Power** and **Reset** until the screen fades off.
4. When the screen has faded off completely, release both **Power** and the stylus.
5. Long press **Send**.
6. Press **Y** to confirm the clean boot.

Today screen

Today screen

The **Today** screen is the home screen of your PDA phone. You will enter the Today screen after you have completed the first-time startup procedure. You can use the Today screen to view the following information:

- Date and time
- On/Off for phone carrier and Bluetooth® (plus WLAN if **Turn on Wireless LAN** is checked after clicking ).
- Owner information
- Unread messages
- Tasks that need to be completed
- Upcoming appointments
- Device (PDA phone) locked/unlocked status
- Pocket MSN sign-in access

The following figure shows the various components on the screen.

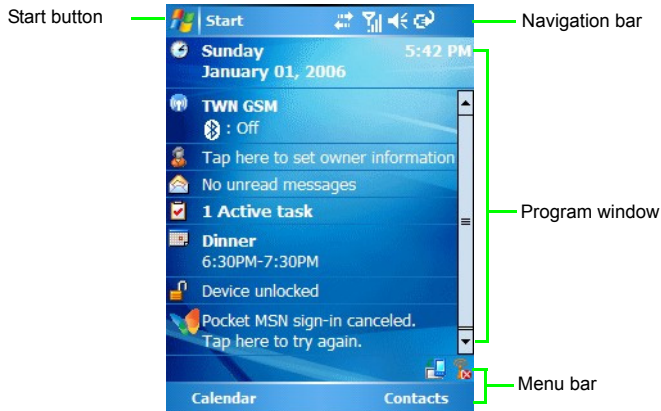

Navigation bar

The navigation bar is located at the top of the screen. It contains the **Start** button, various system icons, and (if you have a program open) the **OK** or **X** button to close the program window. The following figure shows the various components of the navigation bar.



The following describe some of the icons on the navigation bar.

Icon	Meaning
	Adjusts the sound on your phone or other sounds such as ringtone and system sounds. See "Sounds & Notifications" on page 29 for details.
	Backup battery is low.
	Main battery is charging.
	Main battery is low.
	Main battery is very low.
	Main battery is critically low. Please charge the battery immediately.
	Main battery is full.
	Notification that one or more MSN instant messages have been received.
	Notification that one or more e-mail or SMS messages have been received.
	ActiveSync is active.

Available icons may vary depending on the program you are running and the service available in your area. For example, a "G" icon is displayed if you have subscribed to a GPRS service with your SIM card and the GPRS signal is available in the area where your PDA phone is.

Start button

The **Start** button is located on the navigation bar. When you tap the Start button, the Start drop-down menu appears, showing a list of programs and utilities. The figure below shows the various components of the Start menu.

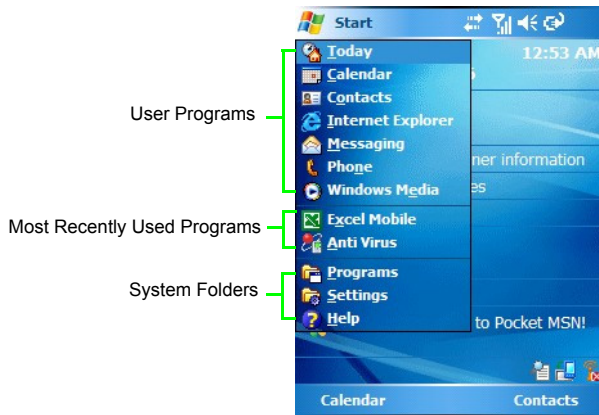





You can customise which programs appear on the Start menu by changing the values in **Settings**.

Menu bar

The menu bar is located at the bottom of the screen. It contains menu names (related to the currently opened program), the Input Panel (if the currently opened program requires text input), and several indicator and shortcut icons such as Wireless LAN. The following figure shows the various components of the menu bar.



The following describe some of the indicators and shortcut icons.

Icon	Meaning
	Tap it for the virus protection menu.
	Tap this icon to rotate the screen anticlockwise.
	Indicates wireless LAN connection status (the red X indicates wireless LAN is currently off). Tap it for settings.
	Indicates that an alarm clock has been set. You can also tap this icon to set the alarm.

In addition, two soft keys are available at the bottom of the screen. For example, in the **Today** screen, you can see **Calendar** and **Contacts**. As you switch to a different screen or program, names and commands for the two soft keys may vary. To control these two soft keys, use the stylus or the two keys beside the joystick.

Input methods

The PDA phone has a number of input methods to choose from. When using the phone function, simply use the QWERTY keyboard to enter the phone number then press the **Send** key. When using a program that supports text input, you have the option of using the QWERTY keyboard or choosing from a number of 'soft' input methods from the Input Panel to enter typed text. The stylus is available as a point-and-click device for navigation. Finally, you can use the stylus to handwrite or make drawings (for certain programs that support this) and have the results saved as graphics. For example, in **Notes**, you can literally scribble notes on the touchscreen and save them to a file.

Entering typed text

When you need to enter typed text in a program, you can do so either with the QWERTY keyboard or one of the input methods provided by the Input Panel. The Input Panel is an icon on the menu bar when you open a program that supports text input.

Using the QWERTY keyboard

The QWERTY keyboard allows you to enter text conveniently - just type on it. You can use the QWERTY keyboard any time you need to type something. For example, use the QWERTY keyboard to key in the phone number you wish to dial in **Phone**. Or type in a long block of text into your **Calendar** or **Word Mobile**. The QWERTY keyboard makes text entry very convenient and is an efficient alternative to the soft input methods as described below.

Using the Input Panel

When you open a program that supports text input, you will see the Input Panel icon appear on the menu bar.



How are you?

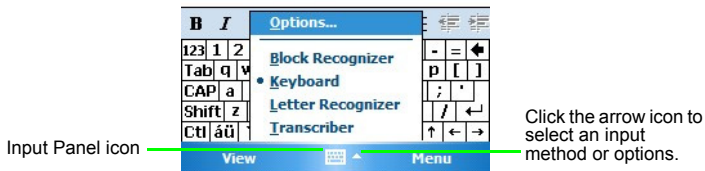

Input Panel icon

Click the arrow icon to select an input method or options.

Input Panel gives you a number of ways to enter text by either tapping on a virtual keyboard on the screen or scribbling to a handwriting recognition tool. The following describes the different methods of text input as provided by the Input Panel.

- Available input methods may vary depending on the language version of the operating system.
- For some languages like traditional Chinese and simplified Chinese, you can hold the Function key and press the Tab key to toggle between English and Chinese.

Virtual keyboard

1. Tap the arrow next to Input Panel, and then tap **Keyboard**.
2. A virtual keyboard will appear on the screen above the menu bar. Tap the keys on this virtual keyboard to enter typed text.

You can change the size of the keys of the virtual keyboard by changing **Options > Settings**.

Letter Recognizer

Letter Recognizer is a handwriting recognition tool that allows you to handwrite one letter at a time while it converts it into typed letter.

1. Tap the arrow next to Input Panel, and then tap **Letter Recognizer**.
2. Write a letter in the box with the stylus.

Letter Recognizer provides three boxes for you to write either an uppercase letter, lowercase letter or number. This division increases the accuracy of its letter recognition ability.

Block Recognizer

With Block Recognizer, you can use the stylus to input character strokes similar to those used on other devices. It uses technology similar to that of Palm's Graffiti product.

1. Tap the arrow next to Input Panel, and then tap **Block Recognizer**.
2. Write a letter in the box.

When you write a letter, it is converted to typed text that appears on the screen. Click the button to open a panel of symbols and special characters to enter in your text.

Transcriber

With Transcriber, you can write anywhere on the screen using the stylus just as you would on paper. Unlike Letter Recognizer and Block Recognizer, you can write a sentence or more of information. Then, pause and let Transcriber change the written characters to typed characters.

1. Tap the arrow next to Input Panel, and then tap **Transcriber**.
2. Write anywhere on the screen.

For specific instructions on using Transcriber, with Transcriber open, tap the question mark in the lower right hand corner of the screen.

Writing on the screen

In any program that accepts writing such as Notes, you can use your stylus to write directly on the screen. Write the way you do on paper. You can edit and format what you have written and convert the information to text at a later time.

To help you write by displaying lines on the screen, open a program like Notes and tap **New** to create a new note, or tap **Menu > Draw** to enable the Draw mode.

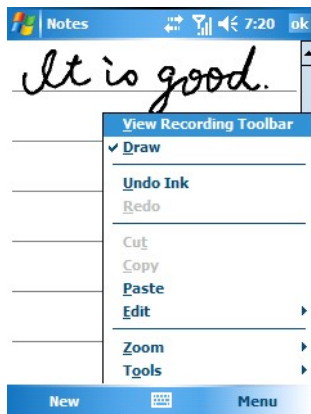

Selecting a sentence

If you want to edit or format writing, you must select it first.

1. Tap and hold the stylus next to the text you want to select until the insertion point appears.
2. Without lifting, drag the stylus across the text you want to select.

If you accidentally write on the screen, tap **Menu > Undo** and try again. You can cut, copy and paste written text in the same way you work with typed text: tap and hold the selected words and then tap an editing command from **Menu**.

Converting writing to text

Tap **Menu > Tools > Recognize**.

If you want to convert only certain words, tap **Menu > Draw** to disable the Draw mode first. Then select these words and tap **Menu > Tools > Recognize**. (or tap and hold the selected words and then tap **Recognize** on the pop-up menu). If a word is not recognised, it is left as writing.

If the conversion is incorrect, you can select different words from a list of alternatives or return to the original writing. To do so, tap and hold the incorrect word (tap one word at a time). On the pop-up menu, tap **Alternates**. A menu with a list of alternative words appears. Tap the word you want to use, or tap the writing at the top of the menu to return to the original writing.



Tips for getting good recognition:

- Write neatly.
- Write on the lines and draw descenders below the line. Write the cross of the “t” and apostrophes below the top line so that they are not confused with the word above. Write full stops and commas above the line.
- For better recognition, try increasing the zoom level to 300% using **Menu > Zoom**.
- Write the letters of a word closely and leave big gaps between words so that the device can easily tell where words begin and end.
- Hyphenated words, foreign words that use special characters such as accents, and some punctuation cannot be converted.
- If you add writing to a word to change it (such as changing a “3” to an “8”) after you attempt to recognise the word, the writing you add will not be included if you attempt to recognise the writing again.

Drawing on the screen

You can draw on the screen in the same way that you write on the screen. The difference between writing and drawing on the screen is how you select items and how they can be edited. For example, selected drawings can be resized, while writing cannot.

Creating a drawing

Cross three ruled lines on your first stroke. A drawing box appears. Subsequent strokes in or touching the drawing box become part of the drawing. Drawings that do not cross three ruled lines will be treated as writing.

 You may want to change the zoom level so that you can work on or view your drawing more easily. Tap **Tools** and then a zoom level.

Selecting a drawing

If you want to edit or format a drawing, disable the Draw mode and then select it.

Tap the stylus on the drawing until the selection handle appears. To select multiple drawings, tap and hold the stylus and then drag to select the drawings you want.

You can cut, copy and paste selected drawings by tapping and holding the selected drawing and then tapping an editing command on the pop-up menu, or by tapping the command from **Menu**. To resize a drawing, drag a selection handle.

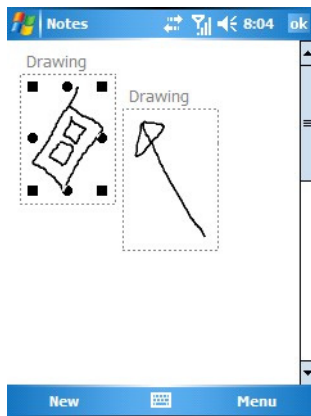

Settings

You can customise how your PDA phone looks and behaves by changing its internal settings. Tap **Start > Settings**, and then tap a tab (**Personal**, **System**, or **Connections**) at the bottom to select an item and its options.

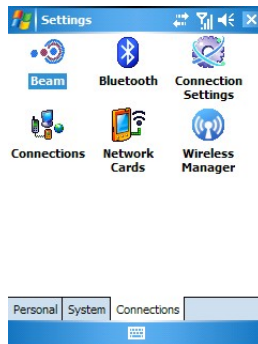

Personal settings

Tap **Start > Settings > Personal** to enter the Personal settings page.

Buttons

This option lets you change button settings from two tabs:

- Program Buttons
- Up/Down Control

Program Buttons lets you map hardware buttons on your PDA phone to functions and installed programs. Just click the name of a button and then select from **Assign a program** for an associated function or program.

Up/Down Control lets you configure how the up and down control behaves for the joystick. **Delay before first repeat** changes the time elapsed before scrolling begins. **Repeat rate** changes the time it takes to scroll from one item to the next.

Input

This option lets you set the default input method in Input Panel. You can also configure various input settings such as whether to use large or small keys for soft keyboard and other details.

Lock

This option lets you enable a password lock on your PDA phone if it is left unused for a certain time.

1. Check **Prompt if device unused for** and tap the arrow beside it to select a time in minutes or hours.
2. Enter a password in **Password**, and then enter it again in **Confirm**. Tap **Hint** to enter a hint message as needed.
3. Tap **Yes** to save the password.

 If password protection is enabled, you will always be prompted for the password after a soft reset or after power up in addition to the specified frequency.

Menus

This option lets you select which programs appear in the **Start** menu. When you launch this dialog box, it scans your system for installed programs. Check the programs (maximum 7) you want to appear in the Start menu.

MSN Options

This lets you set up MSN options such as password, e-mail, display name, SMS and switching sign-in name.

Owner Information

Just as it is wise to label valuable assets with your name or e-mail address, so is it important to stamp your PDA phone with your information.

Fill in your identification and notes to reflect your personal contact information. You can also choose whether to display this information when turning on the PDA phone.

 When you see the Owner Information window, tap anywhere on the screen or press any key (except soft keys) to close the window and then continue using the PDA phone.

Phone

This option lets you to change phone settings from four tabs:

- Phone
 - Services
 - Network
 - More
1. **Phone** lets you change settings like the type of ringtone, the tone of ringtone, keypad dial setting, and security on your PDA phone.
 2. **Services** lets you change settings like call barring, showing your number, call forwarding, call waiting, voicemail box and short message, as well as limiting outgoing calls and messages to designated phone numbers only. Just click an item and tap **Get Settings** for detailed options.
 3. **Network** lets you select an available network to use. Usually the choice of the network that your phone uses is configured automatically. But when outside the coverage of your regular network in your home country or when abroad, you might need to select the local network system manually.
 4. **More** lets you change settings like auto answering, minute minder (the phone beeps once every minute during a call) and the GSM frequency band setting.

Sounds & Notifications

System sounds provide an audio alert when your attention is needed, whether you have an upcoming appointment, an incoming phone call, or someone has sent you an instant message.

This option lets you enable sound for a number of occasions. You can turn on or turn off event sounds (sounds produced by the operating system to indicate errors, for example), program sounds (sounds produced by software you have downloaded) and their notifications. You can also customise the intensity of screen taps or hardware buttons (these can be set to off, soft or loud).

From the same screen, choose the **Notifications** tab to change what sounds are associated with various system events. To change volume, press the Sound level buttons on the left of your PDA phone or tap  on the Navigation bar.

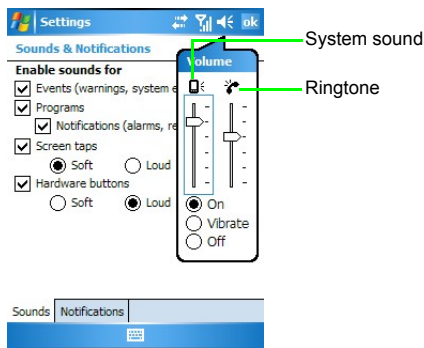

Speech Commander Settings

Here you can enable or disable the voice dialling function of an item such as a contact person or a program. You can also build a custom voice tag by recording your own voice, and thus replace the default voice tag. And you can use **Digi Training** to help your PDA phone adapt to your voice and thus increase the accuracy when using **Speech Commander**.

Today

Aside from acting as the launch point for most activities on your PDA phone, the Today screen is a powerful canvas on which you can add third-party modules to display pertinent information and is customisable to better suit you aesthetically.

Tap **Today** to begin. First you will see a listing of Today themes installed on your device and available for your use. Today screen themes offer a great way for you to personalise your PDA phone and reflect your unique interests and tastes. By loading a new theme, you can completely change the look of your device. To choose a theme, simply highlight its name and tap **OK**. Alternatively, you can Beam a selected theme to a friend's PDA phone or any Pocket PC device or delete the theme from the memory.

You also have the option of selecting a JPG or GIF image as a background skin for your device. To do this, check **Use this picture as the background** and then tap **Browse** to select an image file (except those on the memory card).

The **Items** tab lets you configure the individual Today screen components that have been installed on your device. All of these items (except **Date**) can be moved vertically on the Today screen.

System settings

Tap **Start > Settings > System** to enter the System settings page.

About

This control panel gives you technical details about the version of Microsoft Pocket PC running, processor type and total available internal memory.

It also shows expansion slot (storage slot) usage.

In the same screen, tap the **Device ID** tab to change the name displayed when performing an ActiveSync with a desktop PC.

Finally, the **Copyrights** tab reveals licences being used by your version of Microsoft Pocket PC.

Self Test

This option lets you perform the self test of your PDA phone. Select the items you want to perform the self test on, and then tap **Test** to start testing. When testing, you may go through confirmation messages one by one. When you have finished, a status (e.g. **PASS**) shows to indicate whether the tested function is working properly.

Backlight

Here you can choose how many minutes of inactivity will result in the backlight going off. You can also have the backlight automatically turn on when you press a button or tap the screen. The **External Power** tab provides the same options as the **Battery Power** tab, but these settings affect the behaviour when external power is used such as an AC adapter or car power adapter.

Moreover, you can adjust the screen brightness and whether to run the screen saver from the **Brightness** and the **Screen Saver** tabs.



- You can also turn off the backlight by long pressing **Power**. To resume, long press **Power** again to turn on the backlight.
- To save more power, you can press **Power** to put the PDA phone in to sleep mode. Pressing **Power** will turn on the phone again. See "Sleep mode" on page 14 for details.

Certificates

Public key certificates let you establish your identity when you are logging onto a secure network. Certificates also aid in establishing the identity of other computers that you might want to connect to. Using certificates helps prevent unauthorised users from accessing your device or data. There are two types of certificate that can be installed on your device: personal certificates that identify who you are, and root certificates that identify the servers you connect to. Both personal and root certificates are managed in the same way. Consult your IT department for information on certificates and device security.

On the **Personal** tab, you will see certificates assigned to your device. Tapping the **Root** tab brings you to the root certificates available for your device. By tapping and holding on an item, you can delete it.

Clocks & Alarms

This option lets you set the system clock and alarms. On the **Time** tab, select **Home** and then tap each item to set the time zone, hour, minute, second and date of your location. This information is then used as your system clock. Use arrows or the virtual keyboard to enter the numerical representation of the time. Similarly, select **Visiting** and set the time and date for a different location as needed.

On the **Alarms** tab, you can have up to three distinct alarms enabled at a time:

1. Tap the <Description> text to give your alarm a friendly name. When the alarm goes off, this text will display.
2. Tap **S, M, T**, etc. (indicating Sunday, Monday, Tuesday, etc., respectively) to indicate which days the alarm should go off.
3. Tap the time listed and then use arrows or the virtual keyboard (or tap the time and move the clock hands) to specify the alarm time.
4. To customise how the alarm behaves, tap  to choose the sound played, whether the sound should be looped and so on.



Make sure **Notifications** is selected in **Sounds & Notifications**, so the alarm can sound.

On the **More** tab, you can decide whether to show the clock on the title bar in any program.

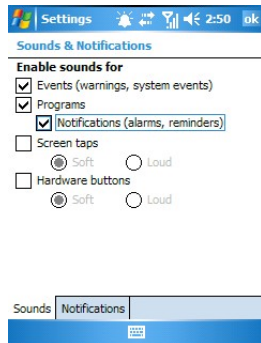
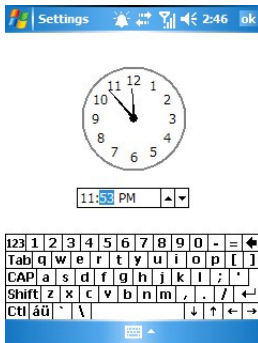
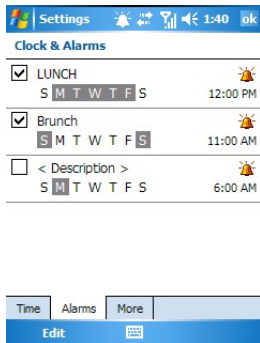

Device Info

This option shows your device information such as CPU type, memory and monitor.

Error Reporting

When the PDA phone detects an error, a text error report - like the one in Windows XP - is generated and can be sent to Microsoft if you choose to do so.

GPS

This option lets you decide the port that programs use to obtain GPS data, the hardware port to which your GPS device is connected and how your PDA phone manages GPS.

☞ You also need to use COM4 and the baud rate at 38400 in the GPS navigation program you are using.

Memory

This option displays total storage and program memory, along with the amount of allocated memory, in-use memory and free memory for both memory types.

The **Storage Card** tab shows you free memory for any storage cards you have installed in your PDA phone.

The **Running Programs** option shows you the currently running programs. By tapping **Activate**, you will bring the highlighted program to the foreground so that you can begin work on it immediately. If you tap **Stop**, the highlighted program will be terminated. Finally, tapping **Stop All** will try to terminate all running programs, though not all will necessarily respond to being closed in this manner.

Power

This option lets you view the current states of the main battery and the backup battery, check how much power is left and decide when to turn off the system if it is idle, or select a CPU performance mode as shown below:

- Automatic mode: adjusts the CPU performance automatically.
- Power saving mode: extends the standby time of your PDA phone, but with less system efficiency.
- Normal mode: maintains efficiency and power consumption for normal system performance.
- Optimization mode: maintains the best system performance, but with higher power consumption.

Regional Settings

This option lets you customise how data appears on your PDA phone, such as currency, times, dates and numbers.

The **Region** tab lets you set the region of your choice.

The **Number** tab lets you customise every aspect of how numbers appear, including decimal symbol, how digits are grouped, measurement system and more.

The **Currency** tab lets you customise every aspect of how monetary figures are displayed, including currency symbol, number of decimal places shown, and how negative values are shown.

The **Time** tab lets you customise every aspect of how time figures are displayed, including display style, separator character and AM/PM symbols.

The **Date** tab lets you customise every aspect of how dates are displayed.

Remove Programs

This options lets you remove a program from the PDA phone. To do so, select a program, and then tap **Remove**.

- You can only remove programs you have installed on the storage memory.
- Programs that came pre-installed on your PDA phone cannot be removed.

Screen

This option lets you change the screen orientation, align the screen (use it when the touch display does not respond accurately to stylus/finger taps), improve text readability, or change the text size shown on the PDA phone.



Shortcut to align screen: Press these three keys (Space, the lowest left and the lowest right) simultaneously.

Connections settings

Tap **Start > Settings > Connections** to enter the Connections settings page.

Beam

Check this option to decide whether to allow receiving of all incoming beams from other devices.

Bluetooth®

The PDA phone comes with built-in Bluetooth® technology that lets you communicate with other Bluetooth® devices over a maximum of approximately 10 metres (30 feet).

To turn on/off Bluetooth®:

1. Tap the Bluetooth  icon in the **Today** screen.
2. Tap the **Bluetooth**  icon to toggle between the on  and off  modes.

When Bluetooth® is powered on, the Connection indicator will blink with a blue light.



Setting up Bluetooth®

1. Tap **Menu > Bluetooth Settings** in the **Wireless Manager** screen, or tap **Start > Settings > Connections > Bluetooth**.
2. Select **Turn on Bluetooth** and **Make this device discoverable to other devices**. (The Bluetooth® status in the Wireless Manager screen will show **Discoverable**, which means Bluetooth® is on and can be found by other Bluetooth® devices.
3. Tap the **Devices** tab.
4. Tap **New Partnership** to begin searching for possible new Bluetooth devices to pair with in the surrounding areas.
5. Once searching ends and devices are found, tap a device name to highlight it and tap **Next**.

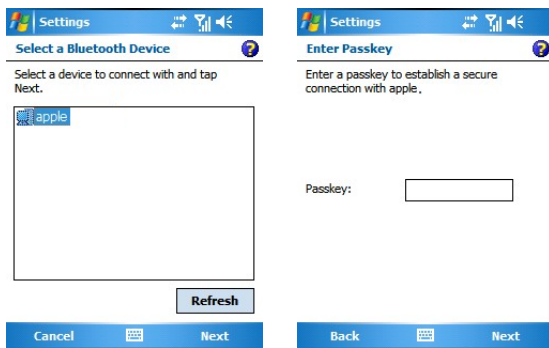

6. Enter the Passkey for the device, and then tap **Finish**.

- ☞ The passkey is device-dependent. Please refer to the documentations of the Bluetooth® device for the passkey.
7. A pop-up message may appear, asking you if you want to add the Bluetooth® device to your device list. Tap **Yes** to establish the connection.
 8. At this point you are ready to exchange data with your paired Bluetooth® device. To send a data object to your paired device, tap and hold on the data object (such as a file, contact object, calendar object, etc) and select **Beam File/Contact/Appointment**, etc.

- The **Beam** window appears, listing all available neighbouring devices ready to receive a beam. Tap the name of a Bluetooth® device to begin sending.

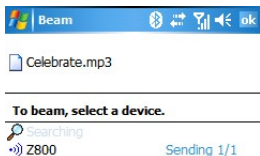

Using a Bluetooth® stereo headset

The PDA phone supports Advanced Audio Distribution Profile (A2DP) which sends a stereo audio stream (such as music) to a Bluetooth® stereo headset.

To set up a Bluetooth® stereo headset:

- Turn on your Bluetooth® stereo headset.
- Create a new partnership (see "Setting up Bluetooth®" on page 36 for details).
- Tap the new partnership name and select the services you want (such as Hands Free, Wireless Stereo, and Headset). Available options vary depending on the headset model. For example, when you select Wireless Stereo, you can then open a program (such as Windows Media) to play back a music file from the PDA phone and listen to the music using your Bluetooth® stereo headset.

Connection Settings

Tap **Start > Settings > Connections > Connection Settings** to select presets of GPRS/CSD/MMS/WAP connections in your area. You only need to select your region, operator and service type, then you can quickly connect to an available network without the hassle of entering lots of setup information.

Connections

The PDA phone can be very easily configured to access the Internet or a corporate network to perform tasks such as browsing the World Wide Web, sending e-mail or exchanging instant messages with friends and co-workers. Connections can be made with a dial-up modem, a wireless modem that is either General Packet Radio Service (GPRS) or Circuit Switched Data (CSD), or a Wireless Local Area Network (WLAN) card.

☞ Available connections and methods for setting up may vary depending on your ISP and country/region.

There are 6 supported groups of connection settings: **WAP**, **MMS**, **CSD**, **WEB**, **My ISP** (which allows you to access the Internet) and **My Work Network** (which allows you to access private resources such as your Intranet, VPN or other protected resources).

☞ **My ISP** and **My Work Network** settings cannot be deleted.

Tap **Start > Settings > Connections > Connections** to enter the Settings page. On the **Tasks** tab, choose an option to set up connections. On the **Advanced** tab, you can access more options such as creating a new network profile (with proper settings) and dialling rules.



Setting up a GPRS and CSD connection to your ISP

You can connect via modem dial-up to your ISP (Internet Service Provider), and use the connection to send and receive e-mail messages and view Web or WAP pages. Your ISP is usually your SIM card provider.

Creating an ISP profile

Obtain the following information from your ISP:

- ISP access point name (for GPRS service only)
- Dial-up access telephone number (for CSD service only)
- User name
- Password
- TCP/IP settings. (Some ISPs require a domain name in front of the user name, such as MSN/username.)

To set up a GPRS connection to your ISP:

1. On the **Tasks** tab of the Settings page, tap **Add a new modem connection** under **My ISP**.
2. Enter a name for the connection and select your modem type. Then tap **Next**.
3. Enter the Access Point Name (APN) of your ISP, and then tap **Next**.

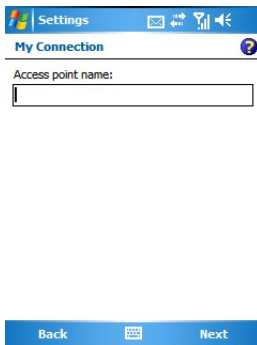
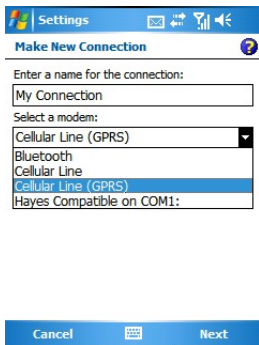

4. Enter any authentication information your ISP requests.

☞ You should not need to change any settings in **Advanced**, because most ISPs now use a dynamic IP address.

5. Tap **Finish**.

Settings

My Connection

User name:

Password:

Domain:*

* If provided by ISP or network administrator.

Advanced...

Back Finish

To set up a CSD connection to your ISP:

1. On the **Tasks** tab of the **Settings** page, tap **Add a new modem connection** under **My ISP**.
2. Enter a name for the connection and select your modem type. Then tap **Next**.
3. Enter the dial-up number of your ISP. Include any special digits such as * or # as needed. Then tap **Next**.

Settings

Make New Connection

Enter a name for the connection:

My Connection

Select a modem:

Cellular Line

Bluetooth

Cellular Line

Cellular Line (GPRS)

Hayes Compatible on COM1:

Cancel Next

Settings

My Connection

Enter the number exactly as it should be dialed. Include any extra numbers, such as an outside line or credit card.

Back Next

4. Enter any authentication information your ISP requests.

☞ You should not need to change any settings in **Advanced**, because most ISPs now use a dynamic IP address.

5. Tap **Finish**.

Settings My Connection

User name:

Password:

Domain:*

* If provided by ISP or network administrator.

Advanced...

Back Finish

To connect to your ISP:

1. On the **Tasks** tab of the **Settings** page, tap **Manage existing connections** under **My ISP**.
2. Tap and hold on a connection name from the listbox to bring up a pop-up menu.
3. Tap **Connect** on the pop-up menu.
4. Your modem will start dialling out and attempt to create a connection.

- ☞
- Network settings and ISP profiles must be set up in advance.
 - When opening a program requiring network connection such as Internet Explorer, the network connection will be established automatically.

Settings My ISP

Tap and hold on an existing connection for more options.

Name	Number
<input type="radio"/> Auto pick	
<input type="radio"/> My Connection 3	5671234
<input checked="" type="radio"/> My Connection 1	5678907

Delete

Connect

Edit... New...

General Modem

Configuring proxy server settings

If proxy server settings are needed, contact your ISP or network administrator for the proxy server name, server type, port, type of Socks protocol used, and your user name and password.

Setting up a VPN connection to your corporate network

With a Virtual Private Network (VPN) connection, you can connect to a server in your corporate network via the Internet.

To create a VPN profile:

1. Obtain the following information from the network administrator of your VPN administrator:
 - User name
 - Password
 - Domain name
 - TCP/IP settings
 - Host name or IP address of the VPN server
 - TCP/IP settings. (Some ISPs require a domain name in front of the user name, such as MSN/username.)
2. On the **Tasks** tab of the **Settings** page, tap **Add a new VPN server connection** under **My Work Network**.
3. Enter the host name and follow the instructions on the screen to proceed.

To edit or delete a VPN profile:

1. On the **Tasks** tab of the **Settings** page, tap **Edit my VPN servers** under **My Work Network**.
2. To edit a VPN profile, tap the profile you wish to edit and then tap **Edit**. To delete a VPN profile, tap and hold the profile you wish to delete, and then tap **Delete** from the menu that appears.

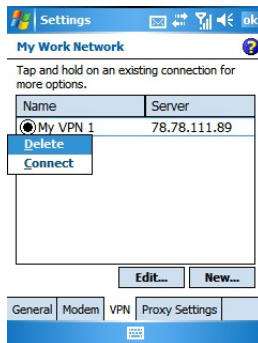



GPRS Authentication

This area lets you select a GPRS authentication method (PAP or CHAP authentication). Please consult your GPRS service provider to determine an appropriate value.

Using WLAN

WLAN lets your PDA phone connect to the Internet, your VPN, or another WLAN-enabled device via a wireless access point.

To turn on WLAN detection:

1. From the **Today** screen, tap the WLAN icon  on the Menu bar and bring up the **Wireless LAN** screen.
2. Check **Turn on wireless LAN** and tap **OK** to close the window. (You will notice that the WLAN icon on the Menu bar changes from  to .)

-  • The Connection indicator will light up green to indicate that WLAN is on.
- Whenever you need to reboot the PDA phone (for example, from the deep sleep mode), you must check **Turn on wireless LAN** again to enable WLAN.

Network Cards - connecting to an existing wireless network

After WLAN is turned on, your phone will automatically try to detect what wireless networks are available in the surrounding areas. If any are found, the icon  will appear on the Navigation bar and the Wireless item shows **WLAN Available** (also shown in **Wireless Manager**).

1. Tap  or **Notification** to see a pop-up message showing all available networks.
2. Tap the network you wish to connect to, and select whether the wireless network connects to the Internet or your work (office) network. Then, tap **Connect** (and follow the instructions required by the network) to complete connection.

-  If further settings (such as Network Key and 802.1x) are needed, tap **Settings** (or tap **Start** > **Settings** > **Connections** > **Network Cards** or tap **Menu** > **WLAN Settings** in Wireless Manager) for the **Configure Wireless Networks** screen. Then tap a network to set up.

Adding a new wireless network

You can add a new wireless network to the listbox.

1. On the **Configure Wireless Networks** screen, tap **Add New**.
2. Enter a name in **Network name**.
3. Next to **Connects to**, select where this new network will connect to (**The Internet** or **Work**).
4. If you want to connect to an ad-hoc connection, tap **This is a device-to-device (ad-hoc) connection**.
5. If authentication information is needed, tap the **Network key** and **802.1x** tabs to fill in the setting values. (Check with your network administrator to obtain the setting values for your specific wireless network.)
6. Tap **OK**.

Searching for wireless networks to access

Networks that you have already configured are preferred networks and are listed in the **Configure Wireless Networks** screen. You can choose whether to connect only to preferred networks.

To do so, under **Networks to access**, tap the type of network you want to connect to (**All Available**, **Only access points**, **Only computer-to-computer**).

USB to PC

This option determines whether to enable advanced USB functionality when connecting to a PC by ActiveSync. If the connection is not stable, disable this option. If the problem still exists, disable the virus protection program and/or the firewall on the PC.

Wireless Manager

This option determines the settings to connect to a wireless network such as Bluetooth®, Phone and WLAN.

Cell Broadcast

This option determines the SMS Cell Broadcast channels you subscribe to. Availability of these services varies depending on your mobile phone service provider.

Phone operation

The PDA phone contains features you would expect from a high-end mobile phone. You can use your PDA phone to make and receive phone calls and send and receive SMS (Short Message Service) and MMS (Multimedia Message Service) messages. Your mobile phone service provider may provide other useful services such as voice mail.

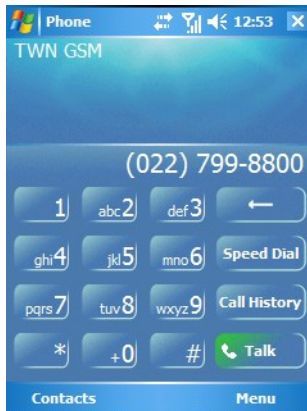

Phone screen

Press **Send**  to bring up the **Phone** screen.



Making and receiving phone calls



Making a call directly

In the **Phone** screen, tap the number you want to call (or enter the number by typing on the QWERTY keyboard), and then press **Send**  or tap  to place a call.







To clear a wrong number, either press the delete button on the keyboard or tap  on the touchscreen.



Answering a call

When you receive a phone call, the phone rings or vibrates and a message will appear on the screen. Press **Send**  or tap **Answer** to answer the call. (Alternatively, you can cancel the call and ringing by pressing **End**  or tap **Ignore**.)





To put the current call on hold, press **Send**  or tap **Hold** . To resume, press **Send**  again or tap **Unhold** .

Ending a call

When you are finished with your phone call, press **End**  or tap **End**  to end the call.

Making a call from Contacts

You can make a call from **Contacts**.

1. To open **Contacts** when you are in the **Today** screen, press the **Right soft key**  or tap **Contacts**. If you are in the **Phone** screen, press the **Left soft key**  or tap **Contacts**.
2. Tap and hold on a contact person to bring up the pop-up menu, or tap a contact person to see the name, phone number and speed dial key.
3. Tap **Call**, **Call Work**, **Call Home**, or **Call Mobile** (depending on how you saved these numbers) to make the call.



Making a speed dial call

Speed dialling allows you to make a call with a single tap of your stylus. The default first speed dial entry is your voice mail.

Making a speed dial call

In the **Phone** screen, tap **Menu > Speed Dial** to display a list of available speed dial entries. Tap the number in front of an entry to dial its number.

Adding a speed dial entry:

1. To open **Contacts** when you are in the **Today** screen, press the **Right soft key**  or tap **Contacts**. If you are in the **Phone** screen, press the **Left soft key**  or tap **Contacts**.
2. Tap and hold on the contact person to bring up the pop-up menu.
3. Tap to select **Add to Speed Dial** to create a speed dial entry for this contact person.
4. In **Speed Dial**, you may change the **Location** for this contact person in the speed dial list.
5. Tap **OK** on the navigation bar to save and exit.

Or you may also add a speed dial entry by the following procedure:

1. Press **Send**, and then tap **Menu > Speed Dial > Menu > New**.
2. Select a contact person, and then tap the up/down arrows to select a desired location.
3. Tap **OK**.

Making a conference call

You can create a three-way conference call between yourself and two or more other parties.

1. Place a call to the first person.
2. While the first call is active, tap **Hold**.
3. Dial a second number to call the second person.
4. While the second call is active, tap **Menu > Conference** to engage in a three-way conference with the first and second parties.
5. If you want to speak to more people, repeat steps 3 and 4.

Loudspeaker

Turn the loudspeaker on and continue your conversation while using other phone functions. This is a great feature for allowing your colleagues to participate in your call.

1. First make a phone call.
2. Tap **Speaker On**, **Menu > Turn Speakerphone On**, or long press **Send**  to turn on the speakerphone function.
3. To turn off the loudspeaker, tap **Speaker Off**, **Menu > Turn Speakerphone Off**, or long press **Send** .



Associating notes with calls

Call notes are integrated into **Notes** as well as the call log. A new folder named **Calls** will be created when the first in-call note is made. You can now create a call note.

1. During a phone call, tap  or **Menu > Create Note**.
2. A note will be created with a header containing all pertinent information: caller, company, phone number, date and time of the call. Write your notes and tap OK when you are finished. You will be returned to the previous screen for the duration of the call.
3. You can now access this note by tapping and holding on the entry in **Call History** and choosing **View Note**, or by selecting the **Calls** folder in **Notes**. Notes are named by the contact from the call or, if the caller is not in **Contacts**, by phone number.

Viewing past phone activity

The PDA phone stores information about all voice calls made to and from the phone in a call log. This is accessed by tapping **Call History** from the **Phone** screen.



In this view, you can see at a glance the phone number of all incoming, outgoing and missed calls, along with when the activity occurred.

Tap an item once, and a small dialog box will show the exact time and duration of the call.

Tap and hold on an item and you will be able to save the entry to **Contacts** (so long as it is not already in **Contacts**), view a note associated with the call, delete the record, send an SMS to the caller, or call the caller.

Selecting **Menu > Call Timers** will bring up a summary of how many minutes were used for all the calls in the log. Here users can also adjust how many weeks or months of calls will be kept in the log. Selecting **Menu > Delete All Calls** will delete the call log screen.













Flight mode

















1. Tap the Wireless item on the **Today** screen (or tap  on the Navigation bar and then tap **Wireless Manager**).
2. Tap  to the right of the Phone item to set the Phone mode to **Off**.











If you want to make a phone call, please turn off the flight mode. Please note that when the battery power is low, the system will turn on the flight mode automatically and will no longer search for the signal of the base station of your network provider. So if you want to make a phone call while the battery power is low, please change the battery or recharge the battery.

Programs

Your PDA phone contains the following built-in programs and tools.

Icon	Program name	Description	Where to find
	Today	Your Home screen or desktop	Page 17
	Calendar	Schedules appointments.	Page 53
	Contacts	An electronic phone book for managing your contacts	Page 54
	Internet Explorer	A Web browser for browsing various on-line content on the Internet	Page 54
	Messaging	Sends and receives e-mail, SMS, MMS messages.	Page 54
	Phone	Makes and receives calls.	Page 45
	Windows Media	Audio/video file player	Page 55
	Programs	Accesses various programs.	See this section.
	Settings	Sets up custom settings for your PDA phone.	Page 27
	Help	A complete online help database	Page 56
	Games	Bubble Breaker and Solitaire	Page 56
	ActiveSync	Synchronises data between your PDA phone and a PC (or an Exchange Server).	Page 71
	Mobile Security	Protects your programs and data from virus attacks.	Page 56

	Calculator	Electronic calculator	Page 56
	Speech Commander	Uses your voice to control programs.	Page 56
	Download Agent	Automates download of software updates and other content.	Page 56
	Excel Mobile	Powerful spreadsheet program	Page 57
	File Explorer	Views files and folders in the phone.	Page 57
	Pocket Studio	A digital camera and camcorder	Page 62
	Pocket Edit	Edits photos.	Page 69
	Java Manager	Manages the Java programs installed in your PDA phone.	Page 57
	Modem Link	Sets up modem connection.	Page 58
	Notes	Jots down your notes.	Page 58
	Pictures & Videos	Views digital photos or video files.	Page 58
	Pocket MSN	Sends and receives instant MSN messages.	Page 58
	PowerPoint Mobile	Opens and views slideshow presentations.	Page 58
	Search	A file searching tool	Page 59
	Set Ringtone	Sets the ringtone of the PDA phone.	Page 59
	SIM Message	Accesses your SIM card SMS messages.	Page 59

	SIM Toolkit	Extra services provided by your SIM card carrier	Page 59
	Skype	Connects to the Skype network for online phone calls and chatting.	Page 60
	Sprite Backup	Backs up all data to an SD card or the internal memory.	Page 60
	Tasks	Manages your to-do items.	Page 60
	Terminal Services Client	Connects to a computer running Terminal Services.	Page 60
	Digital Media Server	Connects to another device using the UPnP protocol.	Page 61
	Word Mobile	Word processor program	Page 61
	Recover Storage	Resets to factory default values.	Page 61
	SIM Upload	Copies the phone book data from a SIM card.	Page 61
	Digital Media Control Point	Plays multimedia files located on another device using the UPnP protocol.	Page 61



You can find help on most of these programs on **Start > Help**.



Calendar

Use **Calendar** to schedule appointments, including meetings and other events. You can check your appointments in one of several views (Day, Week, Month and Agenda) and set Calendar to remind you of appointments with sound or other methods.

To open **Calendar**, tap **Start > Calendar**. If you are in the **Today** screen, you can also press the **Left soft key**  or tap **Calendar**.

Contacts

Contacts maintains a list of your friends and colleagues so that you can easily find the information you are looking for, whether you are at home or on the road. You can enter both personal and business information such as picture, ringtone and company name. If you want to add a contact to your SIM card, tap **Contacts > Menu > New SIM Contact**.

To open **Contacts** when you are in the **Today** screen, press the **Right soft key**  or tap **Contacts**. If you are in the **Phone** screen, press the **Left soft key**  or tap **Contacts**.

Internet Explorer

You can use **Internet Explorer** to view Web pages on your PDA phone in two ways: by downloading pages through synchronisation or by connecting to the Internet. While browsing, you can also download new files and programs to your PDA phone from within the Internet. You can also view WAP pages in Internet Explorer.

To launch Pocket Internet Explorer, tap **Start > Internet Explorer**.

Messaging

You can receive Internet e-mail, multimedia and text messages in **Messaging**. Internet e-mail messages are sent by using an address you receive from your Internet Service Provider (ISP). Text and multimedia messages are sent and received through your mobile phone service provider by using a phone number as the message address. Before sending a multimedia message, you must complete the MMS settings first.

To launch Messaging, tap **Start > Messaging**.

Setting up an MMS connection

There are two ways of setting up an MMS connection.

To set up an MMS connection automatically:

1. Tap **Start > Settings > Connections > Connection Settings**.
2. Select your region, mobile phone service provider and service type.

To set up an MMS connection manually:

1. Before setting the MMS connection, please finish the GPRS setting first. As for the GPRS settings, please refer to "Setting up a GPRS and CSD connection to your ISP" on page 39 for further information.
2. Tap **Start > Messaging > Menu > MMS Settings**, and then select the **General** or **Advanced** tab for settings. For details, tap **Change > Edit**.

 Detailed MMS settings may vary depending on your ISP.

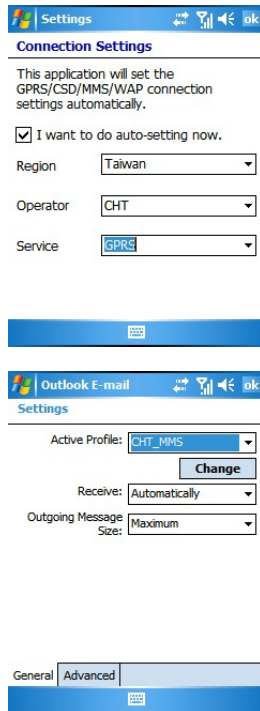

Windows Media

You can use **Windows Media Player** to play digital audio and video files stored on your device or a network such as a Web site.

To launch Windows Media Player, tap **Start > Windows Media**.

 Supported file formats include MP3, AAC, AAC+, AMR, WAV, WMA, WMV, MPEG-4, 3GP, H.263 and H.264.

Help

Help gives you online help documentation for various built-in programs and tools.

To launch Help, tap **Start > Help**.



You can display Help for a particular program or tool by opening that application or tool, and then tapping **Start > Help**. If Help does not contain an entry for that program or tool, then it will not appear in the list.

Games

You have two built-in games in your PDA phone: **Bubble Breaker** and **Solitaire**.

To launch Games, tap **Start > Programs > Games**.

Mobile Security

Mobile Security is a program protecting your PDA phone against virus attack. You can scan files and folders, or update to the latest virus definition at any time.

To launch Mobile Security, tap **Start > Programs > Mobile Security**.

Calculator

Just as there is a Calculator on the PC, you have this function on your PDA phone.

To launch Calculator, tap **Start > Programs > Calculator**.

Speech Commander

Speech Commander allows you to control your PDA phone by voice. You can use voice commands to make a phone call, look up a contact person's information or start a program.

To launch Speech Commander, press the speech commander hot key or tap **Start > Programs > Speech Commander**.

Download Agent

Download Agent is a program that lists the current download status and available downloaded programs for you to install.

To launch Download Agent, tap **Start > Programs > Download Agent**.

Excel Mobile

You can use **Excel Mobile** much the same way you use Excel on your PC. You can enter formulas and functions, and then filter data to see the subset of information you want. Split panes to view different parts of a worksheet at the same time. You can also freeze the top and left-most panes in a worksheet to keep row and column labels or other data visible as you scroll through a sheet.

To launch Excel Mobile, tap **Start > Programs > Excel Mobile**.

File Explorer

Use **File Explorer** to browse through the files and folders that are in your PDA phone. Once you find a file you are interested in, tap it to open it up in its associated program application.

To launch File Explorer, tap **Start > Programs > File Explorer**.

Java Manager

Java Manager is a Java environment on your PDA phone which allows you to download and run Java programs. You may either download the desired Java files from the Internet or beam them in from the PC via ActiveSync or Bluetooth®. Once the files are moved to your phone, you can find them in your **File Explorer** and proceed to install them from there. The installation will in turn move the installed Java program application inside the Java Manager. So when you want to launch a Java program, you must first open up Java Manager and tap to launch it.

Below is the list of supported Java Specification Requests (JSR):

- Connected Limited Device Configuration (CLDC); JSR 30, JSR 139
- Mobile Information Device Profile (MIDP); JSR 37, JSR 118
- Wireless Messaging API (WMA); JSR 120
- Mobile Media API (MMAPI); JSR 135
- Java Technology for the Wireless Industry (JTWI); JSR 185

To launch Java Manager, tap **Start > Programs > Java Manager**.

Modem Link

Modem Link is a program that lets you set up modem settings and activate a modem connection.

To launch Modem Link, tap **Start > Programs > Modem Link**.

Notes

Notes helps you quickly capture your ideas, notes and thoughts. You can create a note using written and typed text, drawings and recordings. You can also share your notes with others through e-mail and synchronisation with your PC.

To launch Notes, tap **Start > Program > Notes**.

Pictures & Videos

Pictures & Videos is a program where you can view image files such as BMP and JPG or videos such as WAV stored on your PDA phone or a memory card. You can then edit or send these files, view a slideshow, or set a picture as the background on the **Today** screen.

To launch Pictures & Videos, tap **Start > Programs > Pictures & Videos**.

Pocket MSN

Pocket MSN on your PDA phone provides the same chat environment as MSN Messenger on your PC. You can use your Pocket MSN to see who is online, send and receive instant messages, group chat, tell contacts that you are unavailable, and block contacts from seeing your status or sending you messages.

To launch Pocket MSN, tap **Start > Programs > Pocket MSN**.

PowerPoint Mobile

You can open and view a PowerPoint slideshow presentation as you would in Microsoft PowerPoint on your PC.

To launch PowerPoint Mobile, tap **Start > Programs > PowerPoint Mobile**.

Search

Use **Search** to find a file or item in your PDA phone. Enter the name of the file or item and select its data type and tap Search. The matched results will be listed on the screen.

To launch Search, tap **Start > Programs > Search**.

Set Ringtone

Set Ringtone assigns a music file as a ringtone. You can choose a file from what is available on the system, or you can upload a file of your own. Set Ringtone supports the following music file types: MIDI, Karaoke, Extensible Music, SMAF, Sound and MP3. When you assign a music file as a ringtone, your PDA phone will copy the file to the following directory: Windows/Rings. If the free memory left in your PDA phone is less than 5 MB, a warning message appears and you are not able to set the ringtone. To set the ringtone, delete unwanted files in the Rings folder.

To launch Set Ringtone, tap **Start > Programs > Set Ringtone**.

SIM Message

SIM Message displays the SMS messages stored on your SIM card. The messages in SIM Message are separate from the messages in the SMS Inbox of Messaging. The messages in Messaging are stored in the ROM memory of your PDA phone, whereas the messages in SIM Message are stored on the SIM card. You can copy data from SIM Message to Messaging by selecting the items on the display and selecting **Copy**. Tap **INBOX SMS** to see what messages are in Messaging.

To launch SIM Message, tap **Start > Programs > SIM Message**.

SIM Toolkit

STK (or SIM Tool Kit) uses the STK services provided by your carrier as part of your subscription.

To launch STK, tap **Start > Programs > SIM Toolkit**.

Skype

Use **Skype** to start online phone calls or chatting as you would on your PC. You need to apply for an ID and password first before using the service.

To launch Skype, tap **Start > Programs > Skype**.

Sprite Backup

To safeguard your data on the PDA phone, use **Sprite Backup** to back it up to an SD card or the internal memory on your PDA phone. You can then restore these data whenever needed.

To launch Sprite Backup:

1. Tap **Start > Programs > Sprite Backup**.
2. (Optional) Tap **Options > Switch Advanced Mode** for detailed settings as needed.
3. Tap **Backup Now** for backup, or **Restore Now** to bring back the data.

 For maximum security, back up your data to an SD card instead of the internal memory.

Tasks

Use **Tasks** to keep track of things you need to do. You can use categories to help you organise your tasks and set reminders for them.

To launch Tasks, tap **Start > Programs > Tasks**.

Terminal Services Client

Use **Terminal Services Client** to log on to a PC running Terminal Services or Remote Desktop, so you can use the programs on that PC from your PDA phone.

To launch Terminal Services Client, tap **Start > Programs > Terminal Services Client**.



Digital Media Server

With the Universal Plug and Play (UPnP) network protocol, you can connect to another device without having to set up anything. All you need is to specify the folder you want to share.

Word Mobile

You can create and edit documents and templates in Microsoft Word Mobile just as you would in Microsoft Word on your PC. Word Mobile documents are usually saved as doc files, but you can also save them in other file formats such as dot, rtf or txt.

You can enter information in a document by typing, writing, drawing or recording. When you close a document, it is automatically named and placed in the Word Mobile document list.

To launch Word Mobile, **Start > Programs > Word Mobile**.

Recover Storage

Same as "Clean boot" on page 16, **Recover Storage** restarts the PDA phone by erasing all data, programs as well as system settings, and therefore returns to its factory default state. To avoid accidentally removing all information stored on the PDA phone, you must type in a set of text as instructed by the screen first before activating the function.

SIM Upload

You can copy all phone book data from a SIM card to Contacts in your PDA phone.







Digital Media Control Point

Just like using a remote control, you can remotely play multimedia files such as audio and video located on another device via UPnP.

Camera/camcorder operation

The PDA phone has a built-in camera/camcorder which allows you to take photographs and record video clips. In addition, the associated **Pictures & Videos**, **Pocket Studio** and **Pocket Edit** provide features for browsing, viewing, and editing your image files.

Taking photographs

1. To enter the camera mode, press the Camera/Camcorder  key on the right side of the PDA phone, tap **Start > Programs > Pocket Studio**, or tap the camera icon  if you are using **Pictures & Videos**.
2. Tap **Menu > Resolution** to select an image size.
3. Tap **Menu > Mode** to select a shooting mode from **Normal** (one shot), **Multi Shot** (burst; available for 240 x 320 images or smaller) or **Timer Shot** (self timer).
4. Customise options such as zoom ratio, white balance, or tap **Menu > Effects** (or tap ) for more colour options.
5. The lens is located on the back of the PDA phone. Tap anywhere on the screen or **Menu > Full Screen** to view the full screen as needed. (Tap anywhere on the screen again to exit full screen.)
6. When you are ready to snap a picture, press the Camera/Camcorder  key or the joystick, or tap **Record**  to activate the shutter and thus take a picture.
7. To take more pictures, press the Camera/Camcorder  key or the joystick, or tap **Camera**. Then repeat Step 2.

 While taking pictures, the PDA phone will automatically enter the **Stand By** mode to save power if it is idle for a while. To resume, tap anywhere on the screen or press any key.

The following figures show the available functions.

Standard capture mode

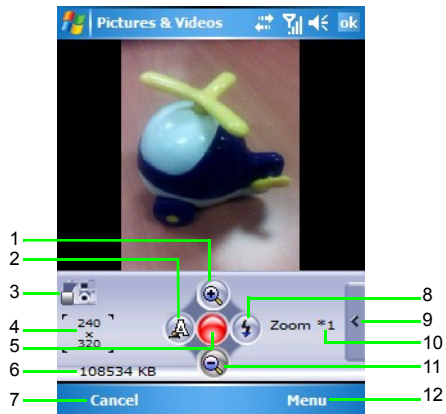





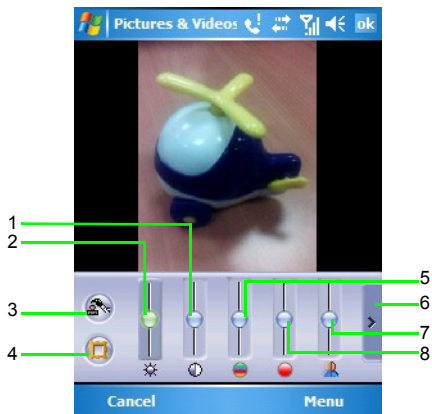





No.	Name	Description
1	Zoom in	Increases the zoom ratio by one (up to 6X).
2	White Balance	Adjusts the lighting condition.
3	Mode status	Shows the currently selected mode (Camera or Camcorder).
4	Resolution	Shows the currently selected image/video size.
5	Record	The Shutter button
6	Remaining space	Shows the available size of the internal memory or the memory card to capture more images or videos.
7	Cancel	Exits the program.
8	Flash	Turns the flash on/off.
9	Effects	Gives an image/video a stylised look by adjusting various colour options.
10	Zoom ratio	Shows the current zoom ratio.
11	Zoom out	Decreases the zoom ratio by one.
12	Menu	Shows more options, including restoring to default.

Colour options



No.	Name	Description
1	Contrast	Adjusts the relative difference between the darkest and lightest areas of an image.
2	Brightness	Adjusts the reflective quality of how bright/dark an image appears.
3	Colour mode	Selects a colour mode such as sepia or black and white.
4	Frame	Selects a frame type such as stamp.
5	Hue	Adjusts the gradation of a colour determined by the light spectrum.
6	Menu toggle button	Toggles between the standard capture mode and the Effects menu.
7	Sharpness	Adjusts the degree of clarity in colours.
8	Saturation	Adjusts the degree of intensity in colours.

Recording videos

1. To enter the camcorder mode, press the Camera/Camcorder  key on the right side of the PDA phone, tap **Start > Programs > Pocket Studio**, or tap the camera icon  if you are using Pictures & Videos.
2. Tap **Menu > Camcorder**.
3. Tap **Menu > Settings > Camcorder** to decide the time limit, the file format and where to save the video file, or tap **Menu > Profiles** and then select a preset.
4. Customise other options such as zoom ratio, white balance, or tap **Menu > Effects** (or tap ) for more colour options.
5. The lens is located on the back of the PDA phone. Tap anywhere on the screen or **Menu > Full Screen** to view the full screen as needed. (Tap anywhere on the screen again to exit full screen.)
6. When you are ready to shoot a video, press the Camera/Camcorder  key or the joystick, or tap **Record** .
7. To pause, press the **Right soft key**  or tap **Pause**. To resume, press the **Right soft key**  again or tap **Resume**. To stop, press the **Left soft key** , the Camera/Camcorder  key or the joystick, or tap **Stop** .

 See for the previous sections "Standard capture mode" on page 63 and "Colour options" on page 64 for option descriptions.

Shooting videos

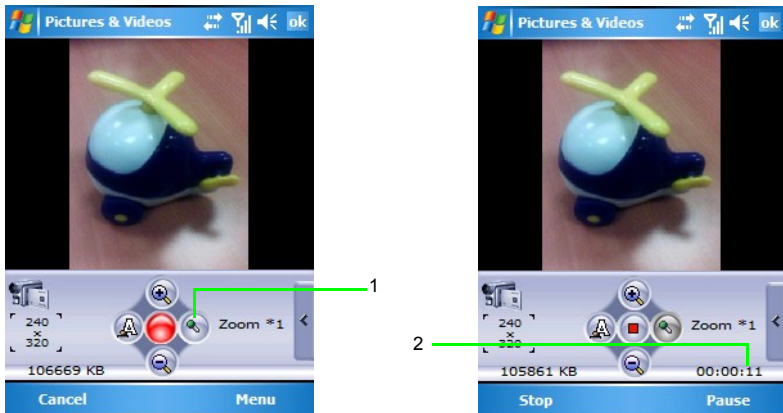

No.	Name	Description
1	Mic on/off	Turns the microphone on/off.
2	Duration	Shows the total video time you have recorded.

Browsing and opening image, video or music files

By default, all pictures and videos you have shot are stored in the **My Pictures** and **My Videos** folders respectively in the internal (main) memory. You can use **File Explorer**, **Pictures & Videos** or **Windows Media** (video and music files only) to find the file you want.

Once it is located, you can tap it to open it.



1 2



3

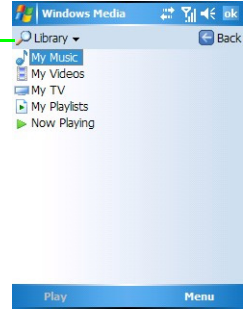

No.	Name	Description
1	Sort By	Arranges files in the order of name, date, size or type.
2	Folder	Shows the folder structure and the currently selected folder.
3	Library	Shows all available media types. Tap any one to expand for more categories and selections.

Viewing images

1. Tap an image to open from within **File Explorer** or **Pictures & Videos**.
2. Tap **Menu** and select an option like **Zoom** or **Play Slide Show** (for multiple image playback) as needed.
3. Move the joystick to the right to view the next image, or to the left to view the previous image.

Viewing videos or playing music

1. Tap a video or music file to open from within **File Explorer** or **Windows Media**.
2. The selected file starts playing automatically. Available controls are similar to those in **Windows Media Player** on your PC or notebook computer. Tap **Menu** for options like **Repeat** or **Properties** as needed.

3. Tap **Menu > Library** or return to **File Explorer** to select another video or music file for playback as needed.

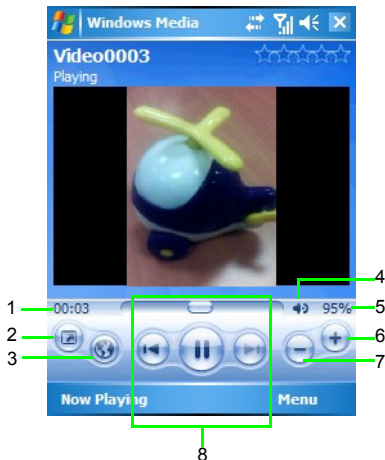
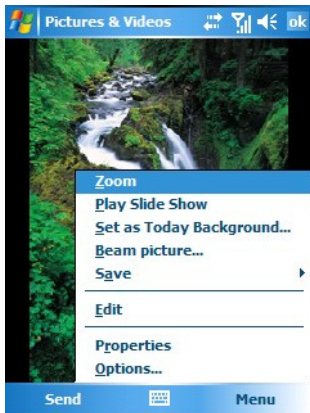

No.	Name	Description
1	Timecode	Shows the current timecode during playback.
2	Full screen	Plays a video in the full screen mode.
3	Windows Media web site	Connects to the Windows Media web site.
4	Volume on/off	Turns the volume on or off.
5	Volume level	Shows the current degree of volume.
6	Volume up	Turns up the volume.
7	Volume down	Turns down the volume.
8	Playback controls	Provides a number of navigation buttons.

Editing an image file with Pocket Edit

You can edit an existing image or create a new one using **Pocket Edit**, which lets you add colour tones, sketches, text overlay and more.

1. Tap **Programs > Pocket Edit**.
2. Tap **Menu > File > Open** and then tap an image file to open, or tap **Menu > File > New** to open a blank image file.
3. Tap from the 9 categories as shown below to do editing as needed. When a category is selected, available options will appear above.

☞ For option description, tap and hold an option to see the pop-up message.

4. If you need to cancel the current editing, you can undo once by tapping **Menu > Edit > Undo**. To revert the image to its original state, tap **Menu > Edit > Restore Original**.
5. Once editing is done, tap **Menu > File > Save As**, and then select file saving options to save to a different image file.

☞ In Step 5, if you select **Save**, the edited file will still be saved as another image file instead of overwriting the original one.

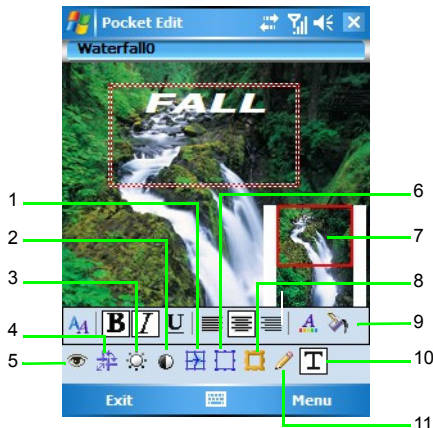

Options in Pocket Edit

No.	Name	Description
1	Effects	Provides colour effects such as sepia and negative.
2	Contrast	Adjusts the relative difference between the darkest and lightest areas of an image.
3	Brightness	Adjusts the reflective quality of how bright/dark an image appears.
4	Crop/Rotate	Provides options for resizing.
5	View	Provides viewing options such as zoom in/out.
6	Warp/Deform	Provides options for deformation.
7	Navigation Window	Provides a compact window for you to move easily to any location of an image. This is particularly useful when an image is enlarged.
8	Frame	Selects a frame type such as stamp.
9	Options for a category	Provides detailed options for a category. These vary as you select a different category.
10	Text overlay	Provides options for typing text. Before typing text, you need to tap a desired location in an image and draw a text box first. Then you can type text within the text box.
11	Pencil/Brush	Provides options for drawing, such as free hand.

Microsoft ActiveSync

Using Microsoft ActiveSync, you can synchronise the information on your desktop computer with the information on your device. Synchronisation compares the data on your device with your desktop computer and updates both computers with the most recent information. For example:

- Keep Pocket Outlook data up-to-date by synchronising your device with Microsoft Outlook data on your desktop computer.
- Synchronise Microsoft Word and Microsoft Excel files between your device and desktop computer. Your files are automatically converted to the correct format.
- Back up and restore your device data.
- Copy (rather than synchronise) files between your device and desktop computer.
- Control when synchronisation occurs by selecting a synchronisation mode. For example, you can synchronise continually while connected to your desktop computer or only when you choose the synchronise command.
- Select which information types are synchronised and control how much data is synchronised. For example, you can choose how many weeks of past appointments you want synchronised.

Installing ActiveSync on PC

Insert the Companion CD containing ActiveSync into the optical drive of your computer, and then follow the instructions on the screen to complete installation.



To ensure that synchronisation works properly, you must install Microsoft ActiveSync on your computer before connecting your PDA phone to the computer.

Setting up a sync relationship

After you have installed ActiveSync on your PC, you can begin to connect your PDA phone to the PC. Take the included data cable and connect the mini-USB end to your PDA phone's mini-USB socket and the USB end to your computer's USB socket.

Once the data cable connects the PDA phone to the PC, the PDA phone will emit a sound indicating connection found. On the PC side, a **Synchronization Setup Wizard** will automatically pop up.

To synchronise information:

1. Decide if you want to synchronise your information with a Microsoft Exchange Server, and then click **Next**.
2. Select an information type (such as Contacts and Calendar) to synchronise, and then click **Next**.
3. Click **Finish** to close the wizard and start synchronisation. During synchronisation, ActiveSync examines each of the information types you selected to be synchronised and sees which records are not the same on both the PDA phone and PC. Once both the PDA phone and PC have the same information, all information types will be listed as **Synchronized**.

After synchronisation, you can check that information you have stored in Microsoft Outlook on your PC has been copied to your PDA phone without having to type a word. Disconnect your PDA phone from your PC and you are ready to go.

Once you have set up ActiveSync and completed the first synchronisation process, you can start synchronisation again any time from your PDA phone or the PC. To do so, connect your PDA phone to the PC and then synchronisation will automatically start. You can also tap **Start > Programs > ActiveSync > Sync** on your PDA phone, or click **Synchronize** from within ActiveSync on the PC.

- If the connection between your PDA phone and the PC is not stable, tap **Start > Settings > Connections > USB to PC** and uncheck **Enable advanced network functionality**. If the problem still exists, disable the virus protection program and/or the firewall on the PC.
- While your PDA phone and the PC are connected, every time the data of an information type is updated (for example, a new e-mail is available in the Inbox), the same update will be synchronised automatically to your PDA phone shortly afterwards.

Adding programs

If you want to install a new program to your PDA phone, you will need to install it first on your PC.

1. Determine your PDA phone's processor type so that you know which version of the software to install. To do so, tap **Start > Settings > System > About > Version**, and then make a note of the information in Processor.
2. Download the program to your PC (or insert the CD or disk that contains the program into your PC). You may see a single *.xip, *.exe, or *.zip file, a Setup.exe file, or several versions of

files for different device types and processors. Be sure to select the program designed for Microsoft Pocket PC and your device processor type.

3. Read any installation instructions, Read Me files, or documentation that comes with the program. Many programs provide special installation instructions.
 4. Connect your PDA phone and PC.
 5. Double-click the *.exe file.
- If the file is an installer, the installation wizard will begin. Follow the directions on the screen. Once the software has been installed on your PC, the installer will automatically transfer the software to your PDA phone.
 - If the file is not an installer, you will see an error message stating that the program is valid but is designed for a different type of computer. You will need to move this file to your PDA phone. If you cannot find any installation instructions for the program in the Read Me file or documentation, use ActiveSync Explore to copy the program file to the Program Files folder on your device. For more information on copying files using ActiveSync, see ActiveSync Help.
 - Once installation is complete, tap **Start > Programs > the program icon** to switch to it.

Removing programs

1. Tap **Start > Settings > System > Remove Programs**.
 2. Select the program you wish to remove.
 3. Click **Remove**, and then follow the instructions on the screen to complete uninstallation.
- After removing a program from your PDA phone, the program might still exist on the PC.
 - While your PDA phone and the PC are connected, you can click **Start > Control Panel > Add/Remove Programs** to remove a program from your PDA phone and/or the PC.

Push Mail

In addition to synchronising with a PC, you can synchronise with the Exchange Server 2003 Service Pack 2. By doing so, without a data cable, you can still receive mails on your PDA phone as soon as there are new ones available from your mail server. This feature is often called “Push Mail”. You can also synchronise Contacts, Calendar and Tasks.

To set up Push Mail:

1. Connect to an existing modem connection such as GPRS.
2. Tap **Start > Programs > ActiveSync**.
3. Tap **Menu > Add Server Source**.
4. Enter the address of your Outlook Web Access server and uncheck **This server requires an encrypted (SSL) connection**. Then tap **Next**.
5. Enter your user name, password and domain name. Then tap **Next**.
6. Choose the data types you want to synchronise.
7. Synchronisation now starts. Wait for a while to receive mails.

 Tap **Menu > Schedule** to customise the synchronisation interval as needed.

Connect to ActiveSync using Bluetooth®

Without a data cable, you can still connect your PDA phone to a computer supporting Bluetooth® (either built-in or with a Bluetooth® dongle).

-  • The computer must use Windows XP Service Pack 2.
- If you are using a Bluetooth® dongle, use the default driver that comes with Windows XP.

To set up a Bluetooth® connection between a computer and your PDA phone:

1. On the computer, right-click the Bluetooth® icon on the Notification area of Windows XP (or click **Start > Control Panel > Bluetooth Device**) to open the Bluetooth Device window.
2. On the **Options** tab, select **Turn discovery on** and **Allow Bluetooth devices to connect to this computer**.
3. On the **COM Ports** tab, click **Add**.
4. Select **Incoming (device initiates the connection)** and click **OK**.
5. Note down the number of the COM port that was added. It is recommended that the COM port number is less than 10.
6. Click **OK**.
7. In ActiveSync on the computer, click **File > Connection Settings**.

8. Check **Allow connections to one of the following**, and then choose the COM port you noted in Step 5.
 9. Click **OK**.
 10. On the PDA phone, create a new partnership with the computer.
 11. The computer name is displayed. Tap it and make sure ActiveSync is checked.
 12. In ActiveSync on the PDA phone, tap **Start > Programs > ActiveSync**.
 13. Tap **Menu > Connect via Bluetooth**.
-  Media (music and video) files can be synchronised only by using a cable connection.

Webaroo

Webaroo is a program that provides services for you to search and browse real web pages without an Internet connection. Therefore, you can take the web with you and find what you are looking for anywhere and anytime. Webaroo stores searchable web content on your PDA phone, and the content can be updated when synchronizing with your computer. For more information, visit <http://www.webaroo.com/>.

Installing Webaroo

To install Webaroo, you first need to install it (along with imported web content from the accompanying disc or the Webaroo web site) on a desktop or laptop computer. Next, install Webaroo on your PDA phone, and then copy the web content from your computer.

To install Webaroo:

1. Insert the accompanying disc to the disc drive of your computer.
2. Locate and run the WebarooSetup.exe file.
3. Follow the instructions on the screen to complete setup. **Webaroo Content Setup** will then appear to help you import the web content from the accompanying disc.
4. Use the USB data cable to connect your PDA phone to the computer that already has Webaroo and ActiveSync installed. **Webaroo Status Window** will then appear automatically. If it does not appear automatically, right-click the Webaroo icon on the Windows taskbar and select **Status Window**.
5. In **Webaroo Status Window** on your computer, click **Install Webaroo** to install Webaroo to your PDA phone.

Once Webaroo is installed, you can copy content to your PDA phone from your computer.

To copy content to your PDA phone:

1. Connect your PDA phone to your computer.
2. Open Webaroo on your computer, and then click **Content**.
3. Select the web packs or the web sites you want to add.
4. Select **Storage Card** from the drop-down list to start copying the content to your PDA phone.



My Library: 297.9 MB (6.1 GB Free) | [Status Window](#)

[add web packs](#) [add web sites](#)

Content	(max size)	Description	Updated On
<input checked="" type="checkbox"/> Milan web pack	68.9 MB (256 MB)	Search for fashion, art and Leonardo Da Vinci... unplugged. Download and learn all about local footb...	27.4.2006
<input type="checkbox"/> Taipei web pack	71.0 MB (256 MB)	Take Taipei in your pocket and discover the commercial, political, and cultural hub of Taiwan. Know ...	27.4.2006
<input type="checkbox"/> Paris web pack	64.1 MB (256 MB)	Paris entertainment, attractions, shopping, fun-facts, and more. Carry the bewitching smile of the M...	28.4.2006
<input type="checkbox"/> London web pack	57.8 MB (256 MB)	Search London... unplugged. Restaurants, business, nightlife, history, theatre, poems on the undergr...	27.4.2006

After copying the content, you can disconnect your PDA phone from the computer, and then start using Webaroo.

Running Webaroo

You can start Webaroo by clicking the Webaroo icon  in the Start menu, or through the shortcut icon  on the screen of your PDA phone.

Alternatively, you can open Webaroo from your Programs folder. Once Webaroo opens in the browser, you can search and browse for the content in the same way you use Webaroo on your computer.

For more information on using Webaroo, see the Help section of Webaroo or the Webaroo user manual on the accompanying disc.

Troubleshooting information

If you encounter problems when using your PDA phone, please refer to the troubleshooting information below to solve them. If the problem still persists after you have tried the suggested solutions, please contact your dealer or customer service for assistance.

 Do not attempt to disassemble the PDA phone by yourself. There are no user serviceable parts inside.

Call-related problems

Cannot make outgoing calls.

 Check the following:

- Is your PDA phone in Flight mode? Change the Phone mode to **On**, so you can use the call-related functions.
- Is there a SIM card in the phone? Install a valid SIM card.
- Is the signal strength strong enough? Try moving to a different location to obtain better signal reception.
- Is the call barring feature activated? Deactivate the feature if necessary.

Cannot answer incoming calls.

 Check the following:

- Is your PDA phone in Flight mode? Change the Phone mode to **On**, so you can use the call related functions.
- Is there a SIM card in the phone? Install a valid SIM card.
- Is the signal strength strong enough? Try moving to a different location to obtain better signal reception.

Cannot use certain call functions (call waiting, call barring, etc).

 Depending on your network service provider, some call services may require an extra subscription. Please contact your network service provider for details.

There are noises during a call.

 Check the following:

- Are you near a strong electromagnetic source (such as a TV, a microwave oven, etc.) during the call? Move to another location to reduce the interference effects.
- Check the status of signal reception. If necessary, move to another location where reception is better.

Poor reception.

 Check the following:

- The network signal is too weak at your current location. In a basement or near a tall building, for example, wireless transmissions may not effectively reach the signal.)
- The network is busy at the current time. (During peak times, for example, there may be too much network traffic to handle additional calls.)
- You are too far away from a base station for your network operator.

Echo or noise.

 Check the following:

- Poor network trunk quality on the part of your network operator.
- Poor local telephone line quality.

SIM card error.

 Check the following:

- SIM card malfunction or damage.
- SIM card not properly inserted.
- Dirt on the SIM card contacts.

There are echoes when using VoIP (Voice over IP) phone.

 Check the following:

Try using VoIP in a more open space or with earphones to get the best reception and quality.

Message problems

? **Cannot send or receive text messages.**

☞ Check the following:

- Is the phone in Flight mode? Change the Phone mode to **On**.
- Is the signal strength strong enough? Try moving to a different location to obtain better signal reception.

? **Cannot send or receive multimedia messages.**

☞ Check the following:

- Is the phone in Flight mode? Change the Phone mode to **On**.
- Have you subscribed to the MMS service from your network service provider? The MMS service may require an extra subscription.
- Has the MMS setting been correctly configured? Check the setting with your network service provider.
- The status of phone memory. Is there enough space? Delete some files if necessary.

? **Cannot send or receive e-mail.**

☞ Check the following:

- Check your network connection.
- Has the e-mail setting been correctly configured? Check the setting with your e-mail service provider.

Internet problems

? **Cannot connect to the Internet.**

☞ See "Connections settings" on page 35 for details.

Connection problems

? **Cannot connect the PDA phone to PC using the data cable.**

☞ Check the following:

- Is the power of the PDA phone turned on?
- Check the data cable.
- Make sure the ActiveSync is installed.

System problems

? Cannot turn the phone on.

☞ Check the following:

- Make sure that you have put the battery lock in the locked position.
- Is the battery fully charged? Check the battery and fully charge it if necessary.
- Are the battery contact terminals clean? Seek your dealer's help to clean the terminals.
- If the problem remains, see "Hard reset" on page 15 for more information.

Battery charging problems

? Cannot turn the PDA phone on when charging.

☞ Check the following:

This shows that the battery is over-discharged when you find the indicator on the PDA phone turns to orange and the PDA phone cannot be turned on while charging it. When the battery is over-discharged, it loses all its electric power. Please charge the phone for over 30 minutes and the system will boot up automatically.

? Cannot turn the PDA phone on after charging for over 30 minutes.

☞ Check the following:

If you find that you still cannot turn the PDA phone on after charging it for over 30 minutes, this means the PDA phone has entered deep sleep mode incorrectly and so cannot be turned on normally. Please note that if there are still some programs running and they are not closed correctly before the PDA phone enters deep sleep mode, the PDA phone will enter sleep mode incorrectly.

Solutions:

Step 1. Press **Power**.

Step 2. If Step 1 does not work, activate soft reset. For details, see "Soft reset" on page 15.

Step 3. If step 2 does not work, activate hard reset. For details, see "Hard reset" on page 15.

? When carrying the phone to board a plane:

☞ Check the following:

- Switch the phone to Flight mode.
- Unlock the battery lock to let the phone enter the deep sleep mode.

ActiveSync problems

? Cannot run ActiveSync or connection fails.

☞ Solution:

- Make sure ActiveSync is properly installed and related settings are correct.
- Restart your system.
- Make sure the data cable is connected properly.

? Connection is not stable.

☞ Solution:

- Tap **Start > Settings > Connections > USB to PC** and uncheck **Enable advanced network functionality**.
- Disable the virus protection program and/or the firewall on the PC.

? Cannot synchronise data.

☞ Solution:

- In ActiveSync on the computer, click **Tools: Options** to make sure at least one data type is selected.
- Make sure the data cable is connected properly.

Care and maintenance

Your phone has been designed and manufactured to the highest of standards and should be treated with great care. The suggestions below will help you to enjoy your phone for many years.

- Protect your phone from moisture and humidity. Precipitation, humidity and liquids contain minerals that will corrode electronic circuits. Should your phone become wet, disconnect it immediately from the power supply to avoid electric shock. Do not place your phone (even to dry it) on/ in a source of heat such as a microwave oven, oven or radiator. The phone may become overheated and possibly explode.
- Do not use or store the phone in dusty, dirty areas. Its moving parts may be damaged and the casing may become deformed and discoloured.
- Do not store your phone in hot environments (e.g. vehicle instrument panel in the summer). High temperatures can shorten the life of electronic devices, damage batteries and warp or melt certain plastics.
- Do not store your phone in cold environments. When the phone warms up again (to its normal ambient temperature), moisture can form inside the phone, which may damage electronic circuit boards.
- Do not drop, knock or shake your phone. Rough handling can damage internal circuit boards.
- Do not use harsh chemicals, cleaning solvents, or strong detergents to clean the phone.
- The phone has better protection against splashes, dust and knocks if the supplied seals are used.

The suggestions given above apply equally to your phone, battery, charger and all accessories. If any of these parts is not working properly, obtain fast and reliable help at our service centres.

Battery quality statement

The capacity of your mobile phone battery will reduce each time it is charged/emptied. Storage at too high or low temperatures will also result in a gradual capacity loss. As a result the operating time of your mobile phone may be considerably reduced, even after a full recharge of the battery.

Regardless of this, the battery has been designed and manufactured so that it can be recharged and used for six months after the purchase of your mobile phone. After six months, if the battery is clearly suffering from loss of performance, we recommend that you replace it. Please buy only original batteries.

Display quality statement

For technological reasons, a few small dots with different colours may appear in the display in exceptional cases.

Just remember that the appearance of brighter or darker dots generally does not mean that a fault has occurred.

Customer Care

We offer fast, individual advice! You have several options:

Our online support on the Internet:

www.BenQMobile.com/customercare

We can be reached any time, any place. You are given 24 hour support on all aspects of our products. Here you will find an interactive fault-finding system, a compilation of the most frequently asked questions and answers, plus user guides and current software updates to download.

You can also get personal advice about our range of products on our Premium Hotline:

United Kingdom **0906 9597500**
(£ 0.75 per minute)

Qualified employees are waiting to offer you expert information about our products and installation.

In some countries repair and replace services are impossible where the products are not sold through our authorised dealers.

If repair work is necessary, please contact one of our service centres:

Abu Dhabi	0 26 42 38 00
Argentina.....	0 81 02 22 66 24
Australia	13 00 55 76 68
Austria	05 17 05 17
Bahrain	40 42 34
Bangladesh	0 17 52 74 47
Belgium	0 78 15 22 21
Bolivia	0 21 21 41 14
Bosnia Herzegovina	0 33 27 66 49
Brunei	02 43 08 01
Bulgaria.....	02 73 94 88
Cambodia	12 80 05 00
Canada	1 88 87 77 02 11
Chile	8 00 53 06 62
China.....	40 08 88 56 56

Colombia.....	01 80 07 00 66 24
Croatia.....	0 16 10 53 81
Czech Republic	2 33 03 27 27
Denmark	35 25 65 29
Dubai	0 43 96 64 33
Ecuador	18 00 10 10 00
Egypt.....	0 23 33 41 11
Estonia.....	56 64 54 00
Finland	09 22 94 37 00
France.....	01 56 38 42 00
Germany.....	0 18 05 33 32 26
Greece.....	80 11 11 11 16
Hong Kong.....	28 61 11 18
Hungary	06 14 71 24 44
Iceland.....	5 20 30 00
India	22 24 98 70 00 Extn: 70 40
Indonesia.....	0 21 46 82 60 81
Ireland.....	18 50 77 72 77
Italy.....	02 45 27 90 36
Ivory Coast	05 02 02 59
Jordan	0 64 39 86 42
Kenya.....	2 72 37 17
Kuwait.....	2 45 41 78
Latvia.....	7 50 11 18
Lebanon.....	01 44 30 43
Libya.....	02 13 50 28 82
Lithuania.....	8 70 07 07 00
Luxembourg.....	40 66 61 56 40
Macedonia.....	0 23 13 18 48
Malaysia	+ 6 03 77 12 43 04
Malta	+ 35 32 14 94 06 32
Mauritius.....	2 11 62 13
Mexico	01 80 01 23 87 46
Morocco	22 66 92 09
Netherlands.....	0 90 03 33 31 00
New Zealand	08 00 27 43 63
Nigeria.....	0 14 50 05 00
Norway.....	22 57 77 46
Oman	79 10 12
Pakistan	02 15 66 22 00
Paraguay.....	8 00 10 20 04
Peru	0 80 05 24 00
Philippines.....	0 27 57 11 18
Poland	08 01 30 00 30
Portugal.....	8 08 20 15 21
Qatar	04 32 20 10
Romania.....	02 12 09 99 66

Russia.....	8 800 200 10 10
Saudi Arabia.....	0 22 26 00 43
Serbia.....	01 13 07 00 80
Singapore.....	62 27 11 18
Slovak Republic.....	02 59 68 22 66
Slovenia.....	0 14 74 63 36
South Africa.....	08 60 10 11 57
Spain.....	9 02 11 50 61
Sweden.....	08 57 92 90 49
Switzerland.....	08 48 84 08 45
Taiwan.....	02 23 96 10 06
Thailand.....	0 29 53 50 00
Tunisia.....	71 86 19 02
Turkey.....	0 21 64 59 98 98
Ukraine.....	8 80 05 01 00 00
United Arab Emirates.....	0 43 66 03 86
United Kingdom.....	0 87 05 33 44 11
Uruguay.....	00 04 05 46 62
USA.....	1 88 87 77 02 11
Venezuela.....	0 80 01 00 56 66
Vietnam.....	84 89 20 24 64
Zimbabwe.....	04 36 94 24

Product data

Declaration of conformity

BenQ Mobile hereby declares that the P51 described in this user guide is in compliance with the essential requirements and other relevant provisions of European Directive 1999/5/EC (R&TTE). The relevant declaration of conformity (DoC) has been signed. Please call the company hotline if you require a copy of the original or visit:

www.BenQMobile.com/conformity

CE 0168

This device complies with Part 15 of the FCC Rules. Operation is subject to the following two conditions:

1. this device may not cause harmful interference, and
2. this device must accept any interference received, including interference that may cause undesired operation.

Changes or modifications not expressly approved by the party responsible for compliance could void the user's authority to operate the equipment.

For body-worn operation, this phone has been tested and meets the FCC RF exposure guidelines when used with the BenQ accessories supplied or designated for this product. Use of other enhancements may not ensure compliance with FCC RF exposure guidelines.

Technical data

GSM 850 class:	4 (2 watt)
Frequency range:	824 - 894 MHz
E-GSM 900 class:	4 (2 watt)
Frequency range:	880 - 960 MHz
DCS 1900 class:	1 (1 watt)
Frequency range:	1710 - 1880 MHz
PCS 1900 class:	1 (1 watt)
Frequency range:	1850 - 1990 MHz
Li-ion battery:	1320 mAh
Operating temp.:	-10 °C... 55 °C
SIM card:	3.0/1.8 V

Phone ID

You will need the following details if you lose your phone or SIM card:

the number of the SIM card (on the card):

.....

15-digit serial number of the phone
(under the battery):

.....

the customer service number of the
service provider:

.....

Lost phone

If you lose your phone or SIM card, contact your service provider immediately to prevent misuse.

SAR

European Union (R&TTE) and international (ICNIRP)

INFORMATION ON RF EXPOSURE / SPECIFIC ABSORPTION RATE (SAR)

THIS MODEL MEETS INTERNATIONAL GUIDELINES FOR EXPOSURE TO RADIO WAVES

Your mobile device is a radio transmitter and receiver. It is designed not to exceed the limits for exposure to radio waves recommended by international guidelines. These guidelines were developed by the independent scientific organization ICNIRP and include safety margins designed to assure the protection of all persons, regardless of age and health.

The guidelines use a unit of measurement known as the Specific Absorption Rate, or SAR. The SAR limit for mobile devices is 2 W/kg and was adopted into the European Standard EN 50360 and into other national standards. The CE mark demonstrates that the EU requirements are met.

The highest SAR value for this device when tested at the ear was **0.346 W/kg**¹. As mobile devices offer a range of functions, they can be used in positions other than the head, such as on the body. In this case, a separation distance of **1.5 cm** is required.

As SAR is measured utilizing the device's highest transmitting power, the actual SAR of this device while operating is typically below that indicated above. This is due to automatic changes to the power level of the device to ensure it only uses the minimum level required to reach the network.

The World Health Organization has stated that present scientific information does not indicate the need for any special precautions for the use of mobile

devices. They note that if you nevertheless want to reduce your exposure then you can do so by limiting the length of calls or using a 'hands-free' device to keep the mobile phone away from the head and body.

Additional Information can be found on the websites of the World Health Organization (www.who.int/emf) or BenQ Mobile (www.BenQMobile.com).

Maximum SAR measurement for FCC requirements

Head: **0.508 W/Kg** (1g)

Body: **0.706 W/Kg** (1g)

1. The tests are carried out in accordance with international guidelines for testing.

Guarantee certificate (UK)

Without prejudice to any claim the user (customer) may have in relation to the dealer or retailer, the customer shall be granted a manufacturer's Guarantee under the conditions set out below:

- In the case of new devices and their components exhibiting defects resulting from manufacturing and/or material faults within 24 months of purchase, BenQ Mobile shall, at its own option and free of charge, either replace the device with another device reflecting the current state of the art, or repair the said device. In respect of parts subject to wear and tear (including, but not limited to, batteries, key-pads, casings, small parts on casings, protective coverings where included in the scope of delivery), this warranty shall be valid for six months from the date of purchase.
- This Guarantee shall be invalid if the device defect is attributable to improper treatment and/or failure to comply with information contained in the user manuals.
- This Guarantee shall not apply to or extend to services performed by the authorised dealer or the customer themselves (e.g. installation, configuration, software downloads). User manuals and any software supplied on a separate data medium shall be excluded from the Guarantee.
- The purchase receipt, together with the date of purchase, shall be required as evidence for invoking the Guarantee. Claims under the Guarantee must be submitted within two months of the Guarantee default becoming evident.
- Ownership of devices or components replaced by and returned to BenQ Mobile shall vest in BenQ Mobile.

- This Guarantee shall apply to new devices purchased in the European Union. For Products sold in the United Kingdom the Guarantee is issued by BenQ Mobile UK Ltd., 1 Arlington Square, Downshire Way, Bracknell, Berkshire, RG12 1WA, United Kingdom.
- Any other claims resulting out of or in connection with the device shall be excluded from this Guarantee. Nothing in this Guarantee shall attempt to limit or exclude a Customer's Statutory Rights, nor the manufacturer's liability for death or personal injury resulting from its negligence.
- The duration of the Guarantee shall not be extended by services rendered under the terms of the Guarantee.
- Insofar as no Guarantee default exists, BenQ Mobile reserves the right to charge the customer for replacement or repair.
- The above provisions do not imply a change in the burden of proof to the detriment of the customer.

To invoke this Guarantee, please contact our online support on the Internet www.BenQMobile.com/customercare or the telephone service. The relevant number is to be found in the accompanying user guide.

Guarantee certificate (IRL)

Without prejudice to any claim the user (customer) may have in relation to the dealer or retailer, the customer shall be granted a manufacturer's Guarantee under the conditions set out below:

- In the case of new devices and their components exhibiting defects resulting from manufacturing and/or material faults within 24 months of purchase, BenQ Mobile shall, at its own option and free of charge, either replace the device with another device reflecting the current state of the art, or repair the said device. In respect of parts subject to wear and tear (including, but not limited to, batteries, key-pads, casings, small parts on casings, protective coverings where included in the scope of delivery), this warranty shall be valid for six months from the date of purchase.
- This Guarantee shall be invalid if the device defect is attributable to improper care or use and/or failure to comply with information contained in the user manuals.
- In particular claims under the Guarantee cannot be made if:
- The device is opened (this is classed as third party intervention)
- Repairs or other work done by persons not authorised by BenQ Mobile.
- Components on the printed circuit board are manipulated
- The software is manipulated
- Defects or damage caused by dropping, breaking, lightning or ingress of moisture. This also applies if defects or damage was caused by mechanical, chemical, radio interference or thermal factors (e.g.: microwave, sauna etc.)
- Devices fitted with accessories not authorised by BenQ Mobile

- This Guarantee shall not apply to or extend to services performed by the authorised dealer or the customer themselves (e.g. installation, configuration, software downloads). User manuals and any software supplied on a separate data medium shall be excluded from the Guarantee.
- The purchase receipt, together with the date of purchase, shall be required as evidence for invoking the Guarantee. Claims under the Guarantee must be submitted within two months of the Guarantee default becoming evident.
- Ownership of devices or components replaced by and returned to BenQ Mobile shall vest in BenQ Mobile.
- This Guarantee shall apply to new devices purchased in the European Union. For Products sold in the Republic of Ireland the Guarantee is issued by BenQ Mobile UK, Branch Ireland, 1st Floor, River-view House, 21–23 City Quay, Dublin– The Republic of Ireland.
- Any other claims resulting out of or in connection with the device shall be excluded from this Guarantee. Nothing in this Guarantee shall attempt to limit or exclude a Customer's Statutory Rights, nor the manufacturer's liability for death or personal injury resulting from its negligence.
- The duration of the Guarantee shall not be extended by services rendered under the terms of the Guarantee.
- Insofar as no Guarantee default exists, BenQ Mobile reserves the right to charge the customer for replacement or repair.
- The above provisions do not imply a change in the burden of proof to the detriment of the customer.

To invoke this Guarantee, please contact our online support on the Internet www.BenQMobile.com/customercare or the telephone service. The relevant number is to be found in the accompanying user guide.

License Agreement

This License Agreement ("Agreement") is between You and BenQ Mobile GmbH & Co. OHG ("BenQ"). The Agreement authorizes You to use the Licensed Software, specified in Clause 1 below, which may be included in your phone, stored on a CD-ROM, sent to You by electronic mail or over the air, downloaded from BenQ Web pages or servers or from other sources under the terms and conditions set forth below.

Read this Agreement carefully before using your phone. By using your phone or installing, copying, and/or using the Licensed Software, You acknowledge that You have read and understood the Agreement and agree to be bound by all of the terms and conditions stated below. You further agree that if BenQ or any licensor of BenQ ("Licensor") is required to engage in any proceeding, legal or otherwise, to enforce their rights under this Agreement, BenQ and/or its Licensor shall be entitled to recover from You, in addition to any other sums due, reasonable attorney's fees, costs and disbursements. If You do not agree to all of the terms and conditions of this Agreement, do not install or use the Licensed Software. This Agreement governs any Updates, releases, revisions, or enhancements to the Licensed Software.

1. **LICENSED SOFTWARE.** As used in this Agreement, the term "Licensed Software" means collectively: all the software in Your phone, all of the contents of the disk(s), CD-ROM(s), electronic mail and its file attachments, or other media with which this Agreement is provided and includes any related BenQ or third party software and upgrades, modified versions, updates, additions and copies of the Licensed Software, if any, distributed over the air, downloaded from BenQ Web pages or servers or from other sources.

2. **COPYRIGHT.** The Licensed Software and all related rights, without limitation including proprietary rights therein, are owned by BenQ, its Licensors or affiliates and are protected by international treaty provisions and all applicable national laws. This Agreement does not convey to You nor allow You to acquire any title or ownership interest in the Licensed Software or rights therein. The structure, organization, data and code of the Licensed Software are the valuable trade secrets and confidential

information of BenQ, its Licensors or affiliates. You must reproduce and include the copyright notices with any permitted copies You make of the Licensed Software.

3. **LICENSE AND USE.** BenQ grants to You a non-exclusive, non-transferable end user right to install the Licensed Software or use the Licensed Software installed on the phone. The Licensed Software is licensed with the phone as a single integrated product and may be used with the phone only as set forth in these licensing terms.

4. **LIMITATIONS ON LICENSE.** You may not copy, distribute, or make derivative works of the Licensed Software except as follows:

(a) You may make one copy of the Licensed Software, excluding the documentation, as an archival backup copy of the original. Any other copies You make of the Licensed Software are in violation of this Agreement.

(b) You may not use, modify or transfer the right to use the Licensed Software other than together with the accompanying hardware or copy the Licensed Software except as expressly provided in this Agreement.

(c) You may not sublicense, rent or lease the Licensed Software.

(d) You may not reverse engineer, decompile, modify, or disassemble those Licensed Software programs except and only to the extent that such activity is expressly permitted by applicable law notwithstanding this limitation.

Parts of the Licensed Software may be supplied by third parties and may be subject to separate license terms. Such terms are set out within the documentation.

5. **MISUSE OF THE LICENSED SOFTWARE OR DATA GENERATED BY THE LICENSED SOFTWARE IS STRICTLY PROHIBITED BY BENQ, MAY VIOLATE GERMAN, U.S. AND OTHER LAWS AND MAY SUBJECT YOU TO SUBSTANTIAL LIABILITY.** You are solely responsible for any misuse of the Licensed Software under this Agreement and for any liability or damage related in any way to your use of the Licensed Software in violation of this Agreement. You are also responsible for using the Licensed Software in accordance with the limitations of this Agreement.

6. TERMINATION. This Agreement is effective from the first date You install, copy or otherwise use the Licensed Software. You may terminate this license at any time by deleting or destroying the Licensed Software, all back up copies and all related materials provided to You by BenQ. Your license rights terminate automatically and immediately without notice if You fail to comply with any provision of this Agreement. The rights and obligations under sections 2, 5, 6, 7, 9, 12 and 13 of this Agreement shall survive the termination of this Agreement.

7. YOU ACKNOWLEDGE THE LICENSED SOFTWARE IS PROVIDED "AS IS" AND NEITHER BENQ NOR ANY OF ITS LICENSORS MAKE ANY REPRESENTATIONS OR WARRANTIES, EXPRESS OR IMPLIED, INCLUDING BUT NOT LIMITED TO THE WARRANTIES OF MERCHANTABILITY OR FITNESS FOR A PARTICULAR PURPOSE OR THAT THE LICENSED SOFTWARE WILL NOT INFRINGE ANY THIRD PARTY PATENTS, COPYRIGHTS, TRADEMARKS OR OTHER RIGHTS. THERE IS NO WARRANTY BY BENQ OR ITS LICENSORS OR BY ANY OTHER PARTY THAT THE FUNCTIONS CONTAINED IN THE LICENSED SOFTWARE WILL MEET YOUR REQUIREMENTS OR THAT THE OPERATION OF THE LICENSED SOFTWARE WILL BE UNINTERRUPTED OR ERROR-FREE AND BENQ AND ITS LICENSORS HEREBY DISCLAIM ANY AND ALL LIABILITY ON ACCOUNT THEREOF. NO ORAL OR WRITTEN INFORMATION OR ADVICE GIVEN BY A BENQ REPRESENTATIVE SHALL CREATE A WARRANTY OR IN ANY WAY AFFECT THIS DISCLAIMER. YOU ASSUME ALL RESPONSIBILITY TO ACHIEVE YOUR INTENDED RESULTS AND FOR THE INSTALLATION, USE, AND RESULTS OBTAINED FROM IT.

8. NO OTHER OBLIGATIONS. This Agreement creates no obligations on the part of BenQ other than as specifically set forth herein.

9. LIMITATION OF LIABILITY. IN NO EVENT SHALL BENQ, ITS EMPLOYEES, LICENSORS, AFFILIATES OR AGENTS BE LIABLE FOR ANY DIRECT DAMAGES, LOST PROFITS, DATA OR BUSINESS, OR COSTS OF PROCUREMENT OF SUBSTITUTE GOODS OR SERVICES, PROPERTY DAMAGE, INTERRUPTION OF BUSINESS OR FOR ANY SPECIAL, INDIRECT, INCIDENTAL, EXEMPLARY, ECONOMIC, PUNITIVE OR CONSEQUENTIAL DAMAGES, HOWEVER CAUSED,

AND WHETHER ARISING UNDER CONTRACT, TORT, NEGLIGENCE, OR OTHER THEORY OF LIABILITY, OR ARISING OUT OF THE USE OF OR INABILITY TO USE THE LICENSED SOFTWARE, EVEN IF BENQ IS ADVISED OF THE POSSIBILITY OF SUCH DAMAGES. THE LIMITATION OF LIABILITY SHALL NOT APPLY IF AND TO THE EXTENT BENQ'S LIABILITY IS MANDATORY UNDER THE APPLICABLE LAW E.G. ACCORDING TO PRODUCT LIABILITY LAW OR IN THE EVENT OF INTENTIONAL MISCONDUCT, PERSONAL INJURY OR DEATH.

10. TECHNICAL SUPPORT. BenQ and its Licensors have no obligation to furnish You with technical support unless separately agreed in writing between You and BenQ or the applicable Licensor.

BenQ and where applicable its Licensors in the Licensed Software shall be free to use any feedback received from You resulting from your access to and use of the Licensed Software for any purpose including (without limitation) the manufacture, marketing and maintenance or support of products and services.

11. EXPORT CONTROL. The Licensed Software may include technical data and cryptographic software and is subject to German, European Union and U.S. export controls and may be subject to import or export controls in other countries. You agree to strictly comply with all applicable import and export laws and regulations. Specifically, You agree, to the extent required by U.S. Export Administration Regulations, that You shall not disclose or otherwise export or re-export the Licensed Software or any part thereof delivered under this Agreement to (a) Cuba, Iran, Iraq, Libya, North Korea, Sudan, Syria or any other country (including a national or resident of such country) to which the U.S. has restricted or prohibited the export of goods or services.

12. APPLICABLE LAW AND FORUM. The laws of Germany govern this Agreement. No choice of law rules of any jurisdiction will apply. The courts in Munich shall settle any disputes arising out of or relating to this Agreement provided you are a merchant.

13. MISCELLANEOUS. This Agreement represents the entire agreement between You and BenQ relating to the Licensed Software and (i) supersedes all prior or contemporaneous oral or written communications, proposals, and representations with respect to its subject matter; and (ii) prevails over any conflicting or additional terms of

any acknowledgement or similar communication between the parties during the term of this License. Notwithstanding the foregoing, some products of BenQ may require You to agree to additional terms through an online "click-wrap" license, and such terms shall supplement this Agreement. If any provision of this Agreement is held invalid, all other provisions shall remain valid unless such validity would frustrate the purpose of this Agreement, and this Agreement shall be enforced to the full extent allowable under applicable law. No modification to this Agreement is binding, unless in writing and signed by a duly authorized representative of each party. This Agreement shall be binding on and shall inure to the benefit of the heirs, successors, and assigns of the parties hereto. The failure of either party to enforce any right resulting from the breach of any provision of this Agreement by the other party will not be deemed a waiver of any right related to a subsequent breach of such provision or any other right hereunder. Notwithstanding anything to the contrary in this Agreement, BenQ and/or its licensors may enforce its rights, including but not limited to copyright, trademark or trade names, in accordance with the rules of law in each country.