

BE BOOK®



User Guide

© 2008 - 2010 Endless Ideas B.V.

Table of content

1 Welcome.....	7
2 Guidelines	8
3 Precautions.....	10
4 Got everything?.....	11
5 Your BeBook Neo eReader at a glance	12
5.1 Power Key.....	14
5.2 MENU Key	14
5.3 BACK Key.....	14
5.4 NEXT Key	14
5.5 PREV Key.....	14
5.6 Direction Key	14
5.7 Volume Keys	14
5.8 Wifi Keys	14
5.9 Headphone Jack	15
5.10 Indicator Light.....	15
6 Getting started.....	16
6.1 Connect BeBook Neo to PC by USB cable.....	16
6.2 Charge BeBook Neo by power adaptor.....	16
7 User Interface.....	17
7.1 Main View	17
7.1.1 Library	18
7.1.2 SD Card.....	19
7.1.3 Recent Documents	20
7.1.4 Shortcuts.....	21
7.1.5 Notes	22
7.1.5.1 Create Note.....	23
7.1.5.2 Open Existing Notes	24
7.1.6 Settings.....	25
7.1.6.1 Date	26
7.1.6.2 Time Zone	27
7.1.6.3 Locale.....	28
7.1.6.4 Power Management.....	29
7.1.6.5 Stylus Calibration.....	30
7.1.6.6 Format Flash.....	35
7.1.6.7 About.....	36
7.1.6.8 Licenses.....	37
7.1.7 Websites	38
7.2 Navigation Bar	39
7.3 Tool Bar.....	40
7.3.1 Menu Button	40
7.3.2 Progress Bar	41

7.3.3 Stylus Indicator	45
7.3.3.1 Sketch	45
7.3.3.2 Erase Sketches.....	45
7.3.3.3 Hand Tool.....	45
7.3.3.4 Selection Zoom	45
7.3.3.5 Annotate	45
7.3.3.6 Erase Annotations.....	45
7.3.3.7 Power Indicator	45
7.3.3.8 Clock	46
7.4 Menu	47
7.4.1 Screen Rotation	47
7.4.2 Save Remove SD Card.....	47
7.4.3 Standby.....	47
7.4.4 Shutdown	47
7.4.5 View	47
7.4.5.1 List View	48
7.4.5.2 Details View	49
7.4.5.3 Thumbnail View.....	50
7.4.5.4 By Name	51
7.4.5.5 By Type	52
7.4.5.6 By Size	53
7.4.5.7 By Access Time.....	54
7.4.5.8 By Rating	55
7.4.5.9 Ascending.....	56
7.4.5.10 Descending.....	57
7.4.6 File	58
7.4.6.1 Delete	58
7.4.6.2 Search.....	59
7.4.6.3 Create shortcut	60
7.4.6.4 Return Book	64
7.4.7 Settings.....	64
7.4.7.1 Date Settings	64
7.4.7.2 Locale Settings.....	64
7.4.7.3 Power Management.....	64
7.4.7.4 Screen Calibration.....	64
7.4.7.5 Format Flash.....	64
7.4.7.6 About.....	64
7.4.8 Font	65
7.4.8.1 By Levels	65
7.4.8.2 By Numbers	66
7.4.8.3 By Ratio	67
7.4.8.4 Bold.....	68
7.4.8.5 Italic	69
7.4.9 Zooming	70

7.4.9.1 To Page.....	70
7.4.9.2 To Width.....	70
7.4.9.3 To Height.....	70
7.4.9.4 Selection Zoom	71
7.4.9.5 By Ratio	73
7.4.10 Annotations	74
7.4.10.1 Add Annotation	74
7.4.10.2 Erase Annotation	75
7.4.10.3 All Annotations.....	76
7.4.10.4 Sketch.....	77
7.4.10.5 Erase Sketch	78
7.4.10.6 Sketch Colors	78
7.4.10.7 Sketch Shapes.....	79
7.4.11 Layout	80
7.4.11.1 Single Page.....	80
7.4.11.2 Scroll Pages	81
7.4.12 Tools.....	82
7.4.12.1 Search.....	82
7.4.12.2 Dictionary Lookup	85
7.4.12.3 Add Bookmark	87
7.4.12.4 Delete Bookmark	88
7.4.12.5 Show Bookmarks	88
7.4.12.6 Hand Tool.....	89
7.4.12.7 Previous View	89
7.4.12.8 Next View.....	89
7.4.12.9 Go To Page	89
7.4.12.10 Slide Show	89
7.4.12.11 Thumbnail View	90
7.4.12.12 Table of Content	91
7.4.12.13 Select Background (of Notepad).....	92
7.4.12.14 Export.....	92
7.4.12.15 Insert Page.....	92
7.4.12.16 Remove Page.....	92
7.4.13 Font Family	93
7.4.14 Encoding	94
7.4.15 Full Refresh Switch.....	95
7.4.16 Navigation.....	95
7.4.16.1 Backward.....	95
7.4.16.2 Forward	95
7.4.16.3 Home	95
7.4.17 Network.....	95
7.4.17.1 Wifi.....	95
7.5 Web Browser.....	96
7.5.1 Tool Bar.....	97

7.5.2 Input by Keyboard.....	97
7.6 Keyboard.....	99
7.6.1 Number Keys	99
7.6.2 Character Keys.....	99
7.6.3 Caps Key.....	100
7.6.4 Backspace.....	100
7.6.5 Space Key	100
7.6.6 Shift Key	101
7.7 Search View	102
7.7.1 Free Text Search.....	102
7.7.1.1 Input Box.....	102
7.7.1.2 Search Button.....	103
7.7.1.3 Clear Button	104
7.7.2 File Search.....	105
7.7.2.1 Input Box.....	105
7.7.2.2 Search Button.....	106
7.7.2.3 Clear Button	107
7.7.2.4 Check Button of Including Subdirectories	107
7.8 Dictionary View	108
7.8.1 Content View.....	108
7.8.2 Explanation Button.....	108
7.8.3 Similar Words Button.....	109
7.8.4 Dictionaries Button	109
7.9 Annotations View	110
7.10 Bookmarks View.....	111
7.11 Wifi Configuration Dialog	112
7.11.1 Scanning List.....	113
7.11.2 Connecting Message Area.....	113
7.11.3 Refresh Button.....	113
7.11.4 Configuring WPA Security Access Point	114
7.11.5 Configuring WEP Security Access Point	115
8 Sketch.....	116
8.1 Make new sketches	116
8.2 Erase.....	117
9 Annotation.....	117
9.1 Add Annotation	117
9.2 Erase Annotations	118
10 OTA Functionalities	119
10.1 Activate Bebook Neo	119
10.2 Fulfillment.....	120
10.3 Return a Loan Book	123
11 Software Update BeBook Neo	124
12 Connect to computer	125
13 Transfer non-drm files to BeBook Neo.....	126

14 How to buy eBooks and transfer files with DRM to BeBook Neo	126
14.1 Download Adobe© Digital Editions	126
14.2 Activation and Authorization	126
14.2.1 Adobe ID	127
14.3 BeBook Neo connection with Adobe© Digital Editions.....	127
14.4 Buying items online	128
15 Transfer non-drm files to BeBook Neo	129
16 Help.....	129
17 Warranty.....	129

1 Welcome...

Thank you for purchasing the BeBook Neo from us.

The BeBook Neo ebook reader is a product of Endless Ideas B.V. Endless Ideas B.V.'s mission is to provide end users with innovative products with an uncompromising user experience. Its products are developed with emphasis on innovation, design, quality, ease of use and value.

The beauty of the Neo is embodied in both its simplicity and its power. BeBook Neo is powered by an 8-level grayscale ePaper screen from E Ink that looks like paper. Passive lighting and diffuse surface relaxes your eyes and reduces eye strain. The hand-writing system lets you take notes while reading and sketch up ideas that happen to emerge. BeBook Neo takes full advantage of new-generation ePaper screens with extremely low power consumption. Each full charge can sustain a few weeks' reading. By reducing paper consumption while providing a realistic paper-like reading experience, digital content helps to protect the environment without sacrificing convenience or life style.

BeBook Neo comes with support for most popular eBook and image formats, including EPUB(DRM), PDF(DRM), HTML, CHM, TXT, and MobiPocket(NON-DRM).... For content partners, we also provide support for custom formats and digital rights management solutions. All of our viewers have standard features such as layout management, fonts adjustment, full text search, zooming, and page reflow....

For a next-generation information device, connectivity is essential. The user can connect to the Internet with build-in Wi-Fi or other add-on modules to download new content or just surf the web. The web browser on BeBook Neo uses Web-Kit, the same software engine that powers desktop browsers such as Safari and Chrome, customized for the ePaper screen.

BeBook Neo, the new reading experience for you.

2 Guidelines

For safe and efficient use of the product, please follow the instructions in this guide.

Do not leave the product in direct sunlight for long periods and do not use in extreme high or low temperature environments. This can cause damage to the product and may damage electronic components and/or the battery.

Do not put or use BeBook in areas of high humidity. Avoid any liquid getting into the product as this can damage the internal electronic circuit.

Always place the product on a stable surface. Violently shaking or dropping the product will cause damage to the product and its electronic components.

Do not press on the screen or put heavy weights on it.

Do not expose your product near magnetic fields.

Please use the authorized accessories, do not use third party components or third party accessories.

Do not attempt to repair or take the product apart. This will void your warranty. Only qualified personnel from Endless Ideas B.V or an authorized BeBook maintenance center can repair the product.

Do not use the rechargeable battery if it is damaged in any way.

If the battery leaks liquid, please clean the BeBook and replace with a new battery.

If liquid has leaked from the battery and comes in contact with human skin, please carefully rinse and consult a doctor.

Please properly dispose of old and waste batteries.

Do not use chemical solvent to clean the surface of the product. Please use a soft cloth to wipe off the dust from the surface of the screen of cover.

Product disposal instructions

Product that include the WEEE [The Waste of Electrical and Electronic Equipment] symbol, should not be placed in the normal household rubbish, but should be disposed by using the appropriate WEEE disposal facility. These facilities may be advised to you by your local council or the retailer from which the product(s) was purchased.



Operating temperature is 0°C to 50°C

Storage temperature is -20°C to 70°C

The latest downloads and product news are available at our website:

www.mybebook.com

3 Precautions

Avoid applying excessive force to the display. The device uses a glass based display is thus liable to break if mistreated.

Never open the device as this will invalidate any warranty or manufacturer's responsibility. Please contact your retailer if you have any technical difficulties or visit the BeBook forum for support. You may need simple instructions to correct a problem with your product. If the problem cannot be solved with the troubleshooting information available online, you will be offered service through Endless Ideas B.V. Please **do not** send any products to Endless Ideas B.V. without contacting us first.

If you think you need to return you BeBook for service or malfunction, please visit the following website for detailed instructions: **www.mybebook.com/support**

4 Got everything?

- BeBook Neo eReader
- USB Cable
- User Guide (Pre-installed)

Need more information?

Please visit www.mybebook.com

5 Your BeBook Neo eReader at a glance

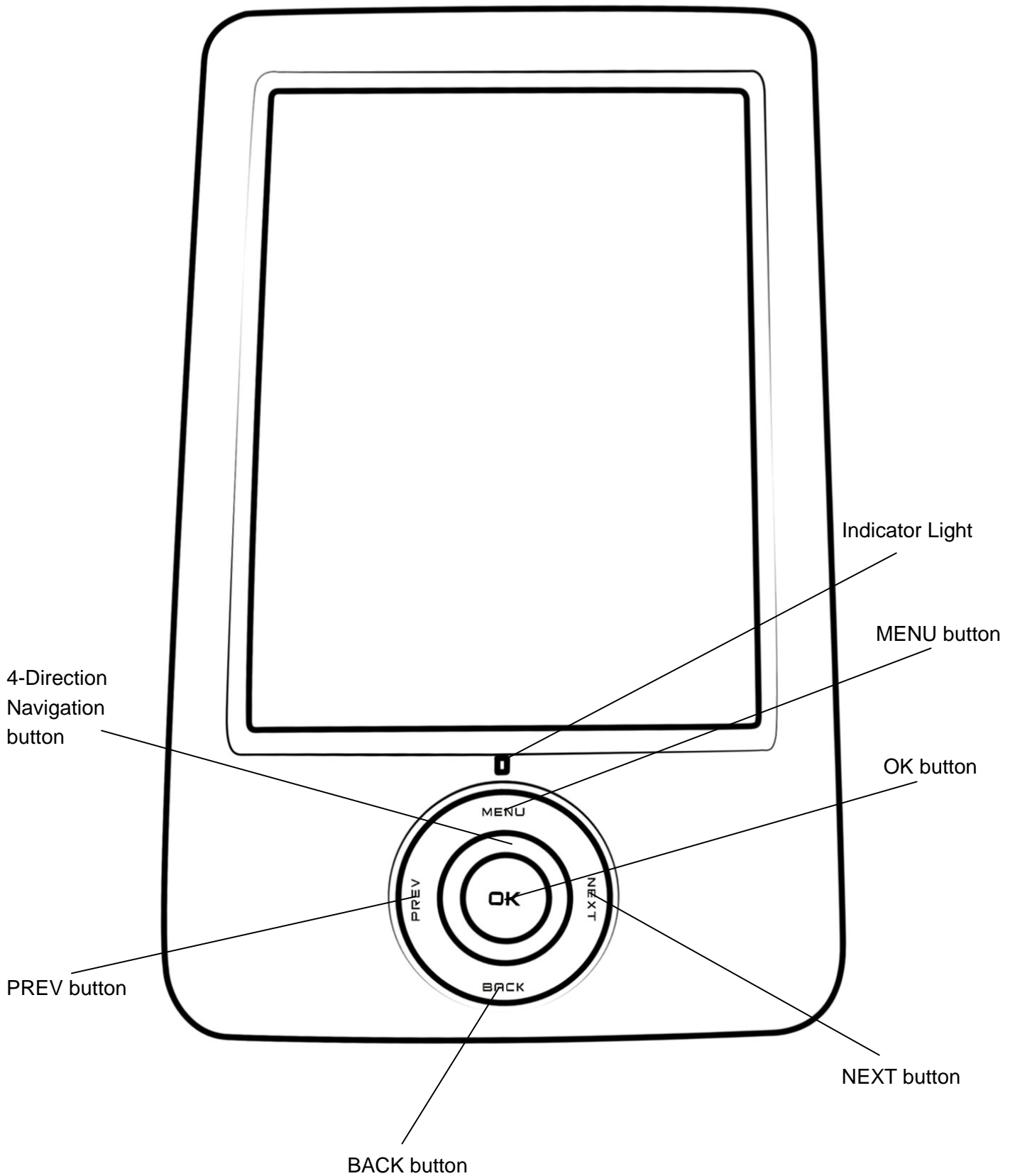

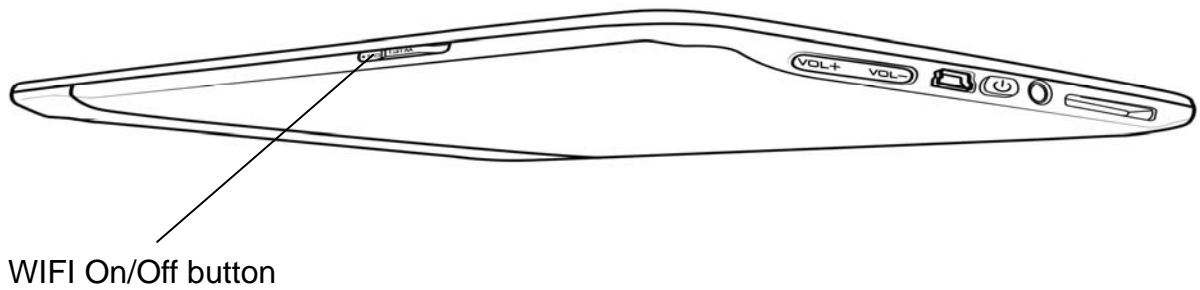
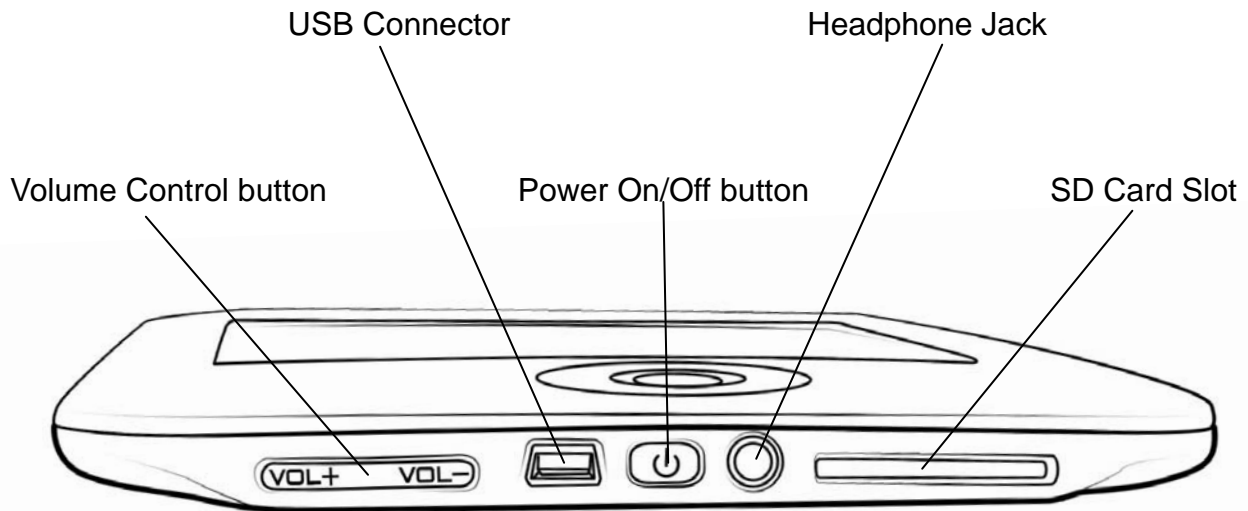

5.1 Power Key

- Press the power key to turn device on
- Press the power key and hold for 2 seconds to turn device off, similar as selecting shutdown item in menu
- Press the power key and release it immediately, device will go into sleep mode.

5.2 MENU Key

- Press the menu key to pop up the menu
- Similar as tapping  icon with stylus

5.3 BACK Key

- Return from current application
- Return from current view or dialog
- Turn back to the parent directory

5.4 NEXT Key

- Flip to next screen while viewing document
- Flip to next screen while browsing documents in main view

5.5 PREV Key

- Flip to previous screen while viewing document
- Flip to previous screen while browsing documents in main view

5.6 Direction Key

- Navigate items on current screen, e.g. navigate from *Library* to *SD Card* by pressing RIGHT key
- Turn back to previous view or forward to next view while reading PDF/EPub documents
- Navigate the view on the current webpage.

5.7 Volume Keys

- Increase the volume by pressing key *Vol+*
- Decrease the volume by pressing key *Vol-*

5.8 Wi-fi Keys

- Turn on the wi-fi by sliding the wi-fi key from bottom to top
- Turn off the wi-fi by sliding the wi-fi key from top to bottom

5.9 Headphone Jack

Diameter of the headphone jack is 3.5mm.

5.10 Indicator Light

The indicator light is on while charging.

6 Getting started

You can charge the BeBook Neo by two ways:

6.1 Connect BeBook Neo to PC by USB cable

BeBook Neo can be easily connected to PC with the supplied USB cable. A dialog pops up immediately after the connection establishes. If you press 'No', BeBook Neo will charge and you will be able to use it at the same time. (Charging will take longer when you operate on BeBook Neo)

To charge the battery for the first time, please allow 12 hours of continuous charging. Subsequently, it takes about three hours to fully charge the battery from flat.

6.2 Charge BeBook Neo by power adaptor

Your BeBook Neo can also be charged by a power adaptor (not supplied). Connect your BeBook to the power adaptor with USB, and plug the power adaptor into a power socket.

7 User Interface

7.1 Main View

Like the desktop of the most popular PC and OS, the main view of BeBook Neo provides entries to access the storages, device settings and common websites.



Fig. 7.1 Snapshot of Main View



7.1.1 Library

Select the Library button (by stylus or keyboard), all of the items stored in internal memory are retrieved.

🏠 **Library**

	<p>license.txt Last Access: 2010-01-24 00:00 Read count: 0 Progress: Not Read</p>	<p>★★★★★ 45KB</p>
	<p>screen_saver001.png Last Access: 2010-01-24 00:00 Read count: 0 Progress: Not Read</p>	<p>★★★★★ 286KB</p>
	<p>screen_saver002.png Last Access: 2010-01-24 00:00 Read count: 0 Progress: Not Read</p>	<p>★★★★★ 250KB</p>
	<p>screen_saver003.png Last Access: 2010-01-24 00:00 Read count: 0 Progress: Not Read</p>	<p>★★★★★ 289KB</p>
	<p>screen_saver004.png Last Access: 2010-01-24 00:00 Read count: 0 Progress: Not Read</p>	<p>★★★★★ 214KB</p>
	<p>screen_saver005.png Last Access: 2010-01-24 05:11 Read count: 0 Progress: Not Read</p>	<p>★★★★★ 283KB</p>
	<p>screen_saver006.png Last Access: 2010-01-24 05:11 Read count: 0 Progress: Not Read</p>	<p>★★★★★ 277KB</p>

↶ 1/8 

Fig. 7.1.1 Snapshot of Library View



7.1.2 SD Card

Select the SD Card button, all of the items stored in SD card are retrieved.

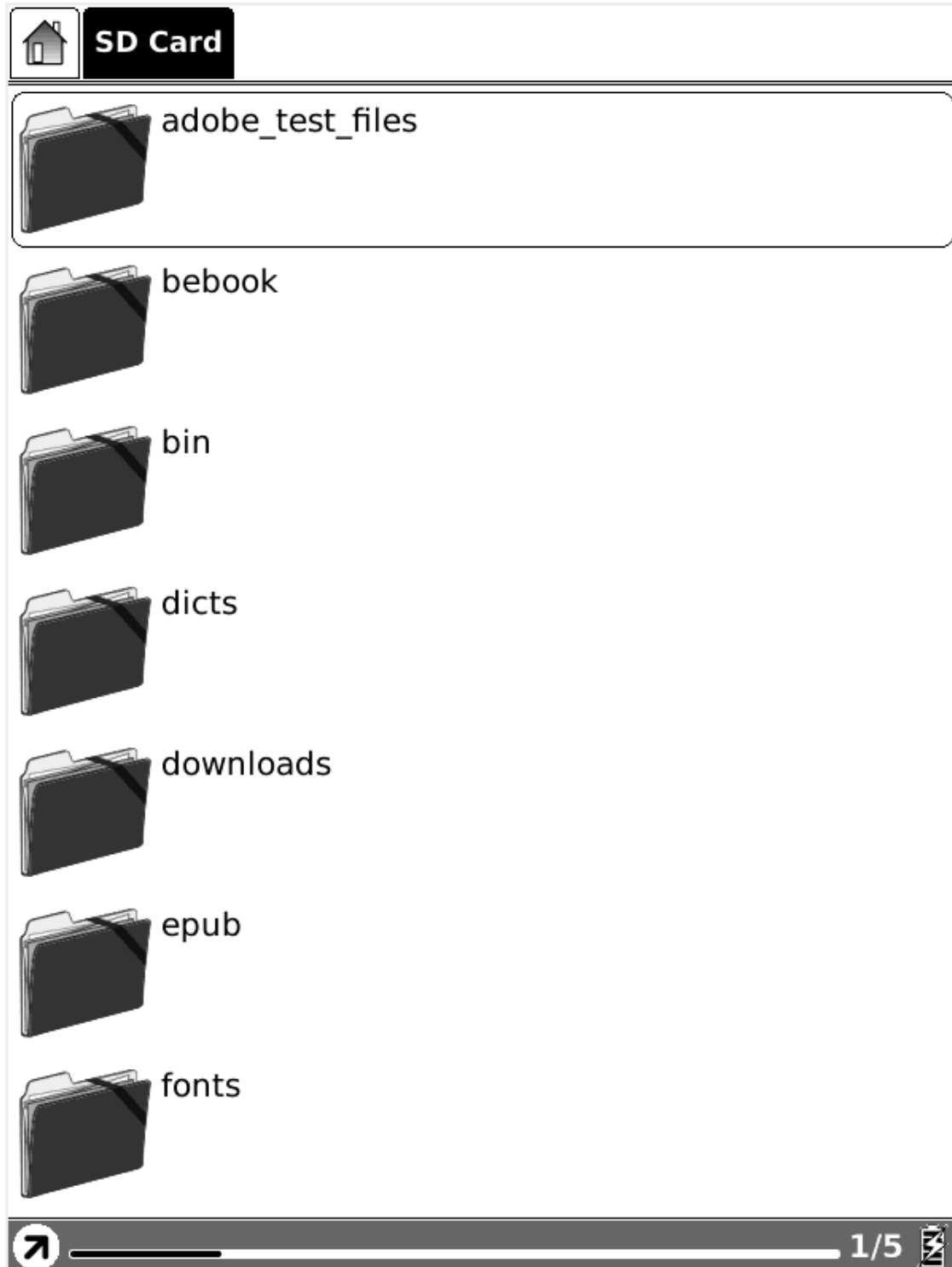

Fig. 7.1.2 Snapshot of SD Card View



7.1.3 Recent Documents

Select the Recent Documents button, all of the recent read documents are displayed.

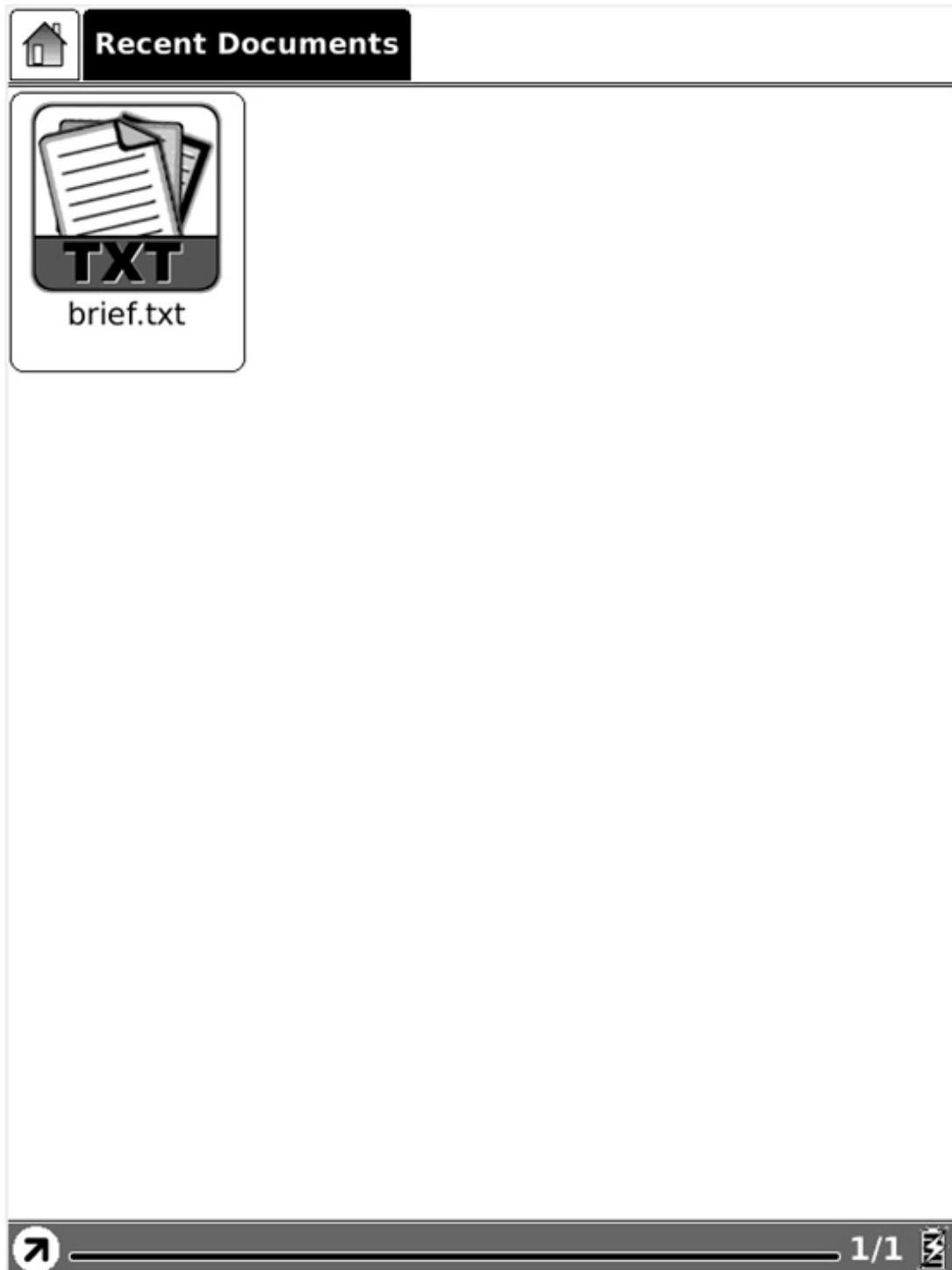

Fig. 7.1.3 Snapshot of Recent Document View



7.1.4 Shortcuts

Select button Shortcuts, all of the shortcuts to specified applications or documents are displayed in a single view. Once the shortcut for an application or a document is created (please refer to [7.4.6.3](#)), you can start or open it by shortcut directly.

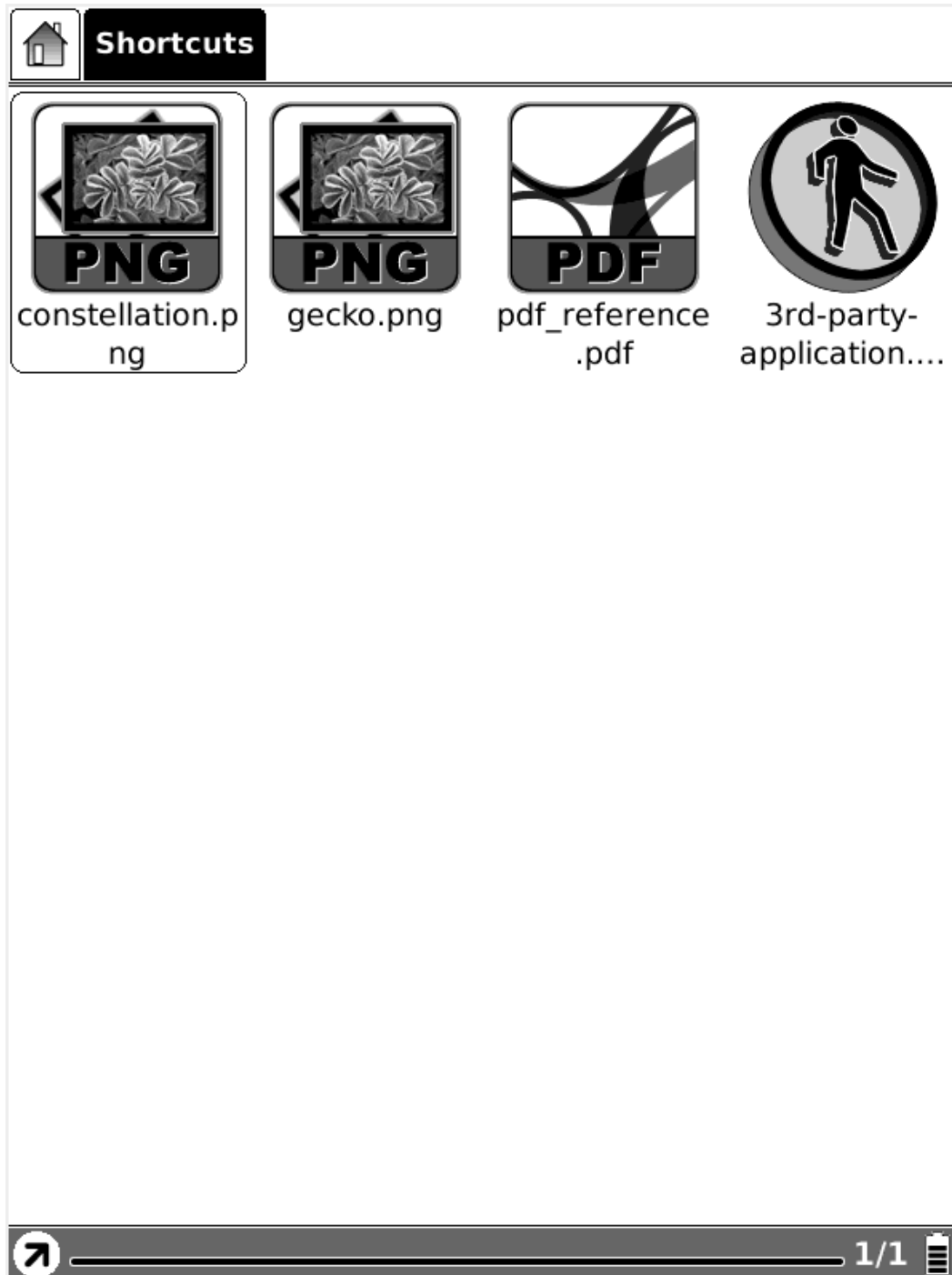

Fig. 7.1.4 Snapshot of Shortcut View

Note: The third-party application developed for BeBook Neo can be executed directly in SD card or internal flash.



7.1.5 Notes

Select button Notes, you can create a new notepad or open the existing notes.

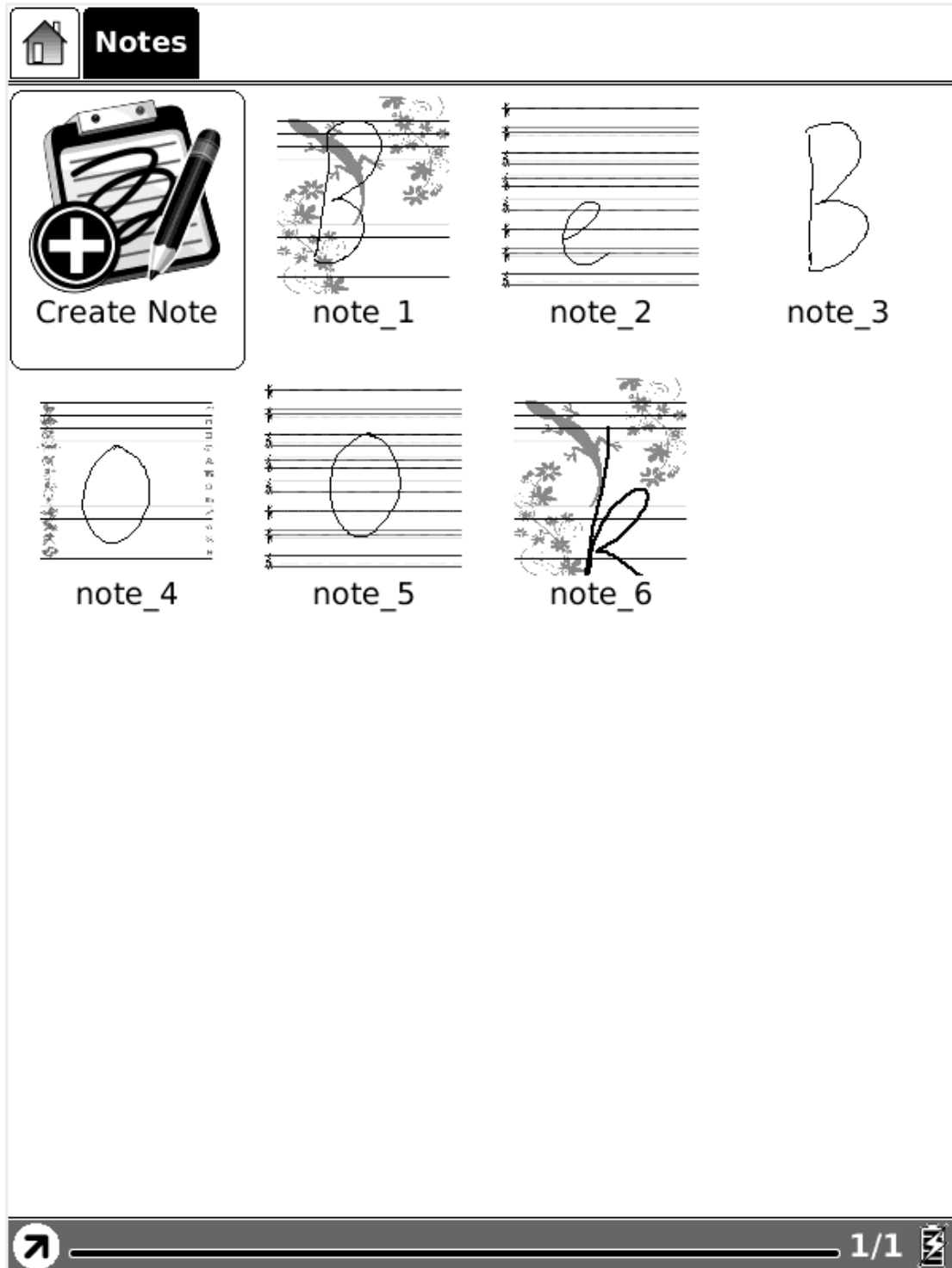

Fig. 7.1.5 Snapshot of Notes View



7.1.5.1 Create Note

Create a new notepad. Before you sketch any ideas on your BeBook Neo, a dialog pops up letting you select the background of notes, as shown in Fig. 7.1.5.1.

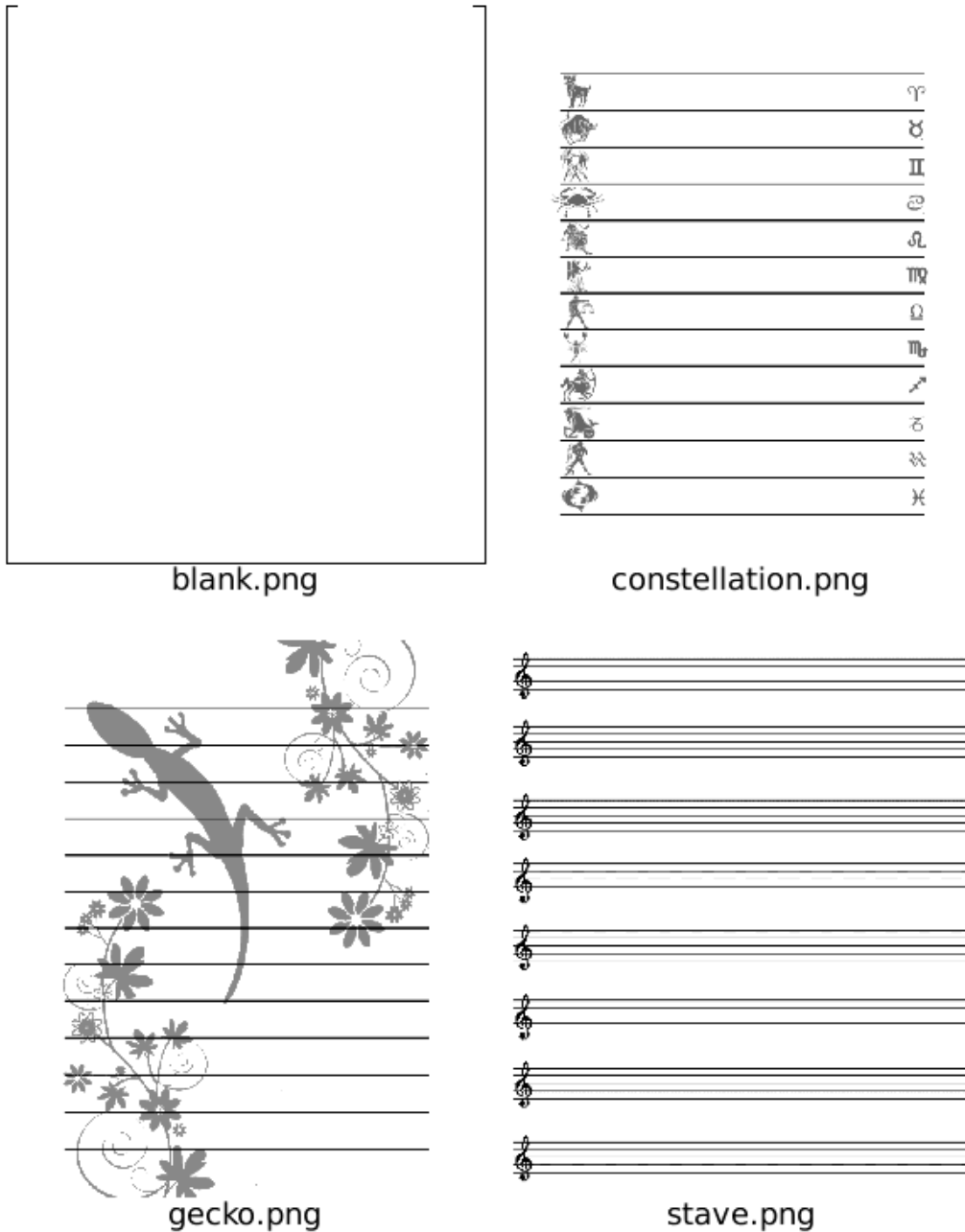

Fig. 7.1.5.1 Snapshot of Selecting Note Background

NOTE:

You add any background as you like. The steps are:

1. Create a folder notes_template in your SD card.
2. Put the background images in that specific folder. BeBook recommends you to use images with the following dimension: 600 x 800.

7.1.5.2 Open Existing Notes

All notes are saved in internal memory of BeBook Neo. You can see and open them in Notes view, just like opening a normal document. The thumbnail of the first sketched page will be displayed in Notes view.



7.1.6 Settings

Select Settings button, you can enter the device settings view. Now the configuration of date, locale, power management are supported. Stylus calibration, format flash and about view are also listed here.



Fig. 7.1.6 Settings



7.1.6.1 Date

Select the Date button in settings, you can set current date (year, month, day) and time (hour, minute, second) of device.



Fig. 7.1.6.1 Data Configuration Dialog



7.1.6.2 Time Zone

Select button Time Zone in settings, you can set the time zone on BeBook Neo. The time zone setting is very important for DRM functionalities. Make sure your device is set to the correct time zone.



Fig. 7.1.6.2 Time Zone Settings



7.1.6.3 Locale

Select the Locale Button in settings, you can set the current operation language of the device.

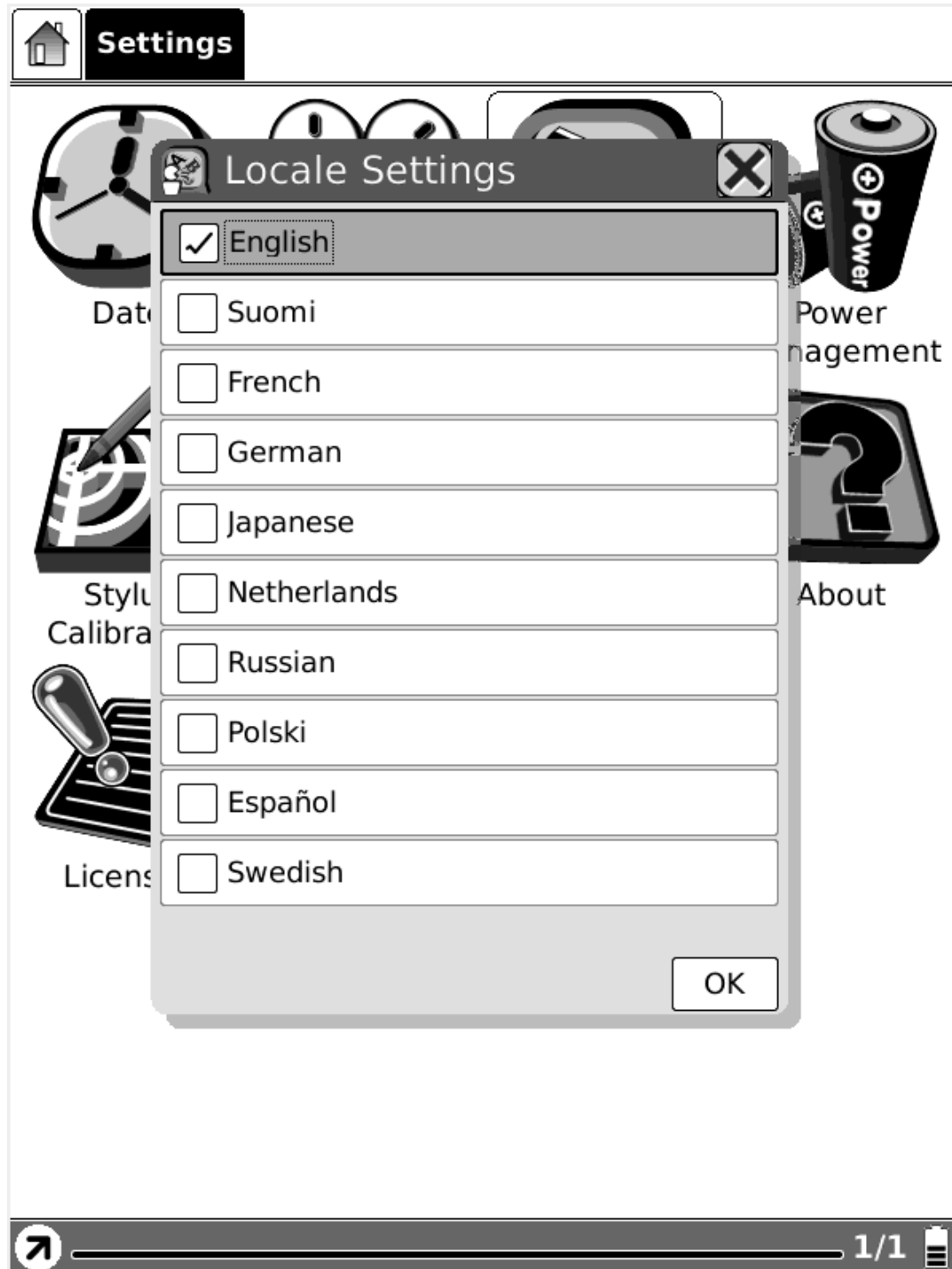

Fig. 7.1.6.3 Locale Dialog



7.1.6.4 Power Management

Select the Power Management button in settings, you can set the (waiting) time of standby and automatically shut down for the device. Note, if the time of shutdown is set, the device won't enter standby status anymore; if you set the time of standby, the device won't shutdown automatically.

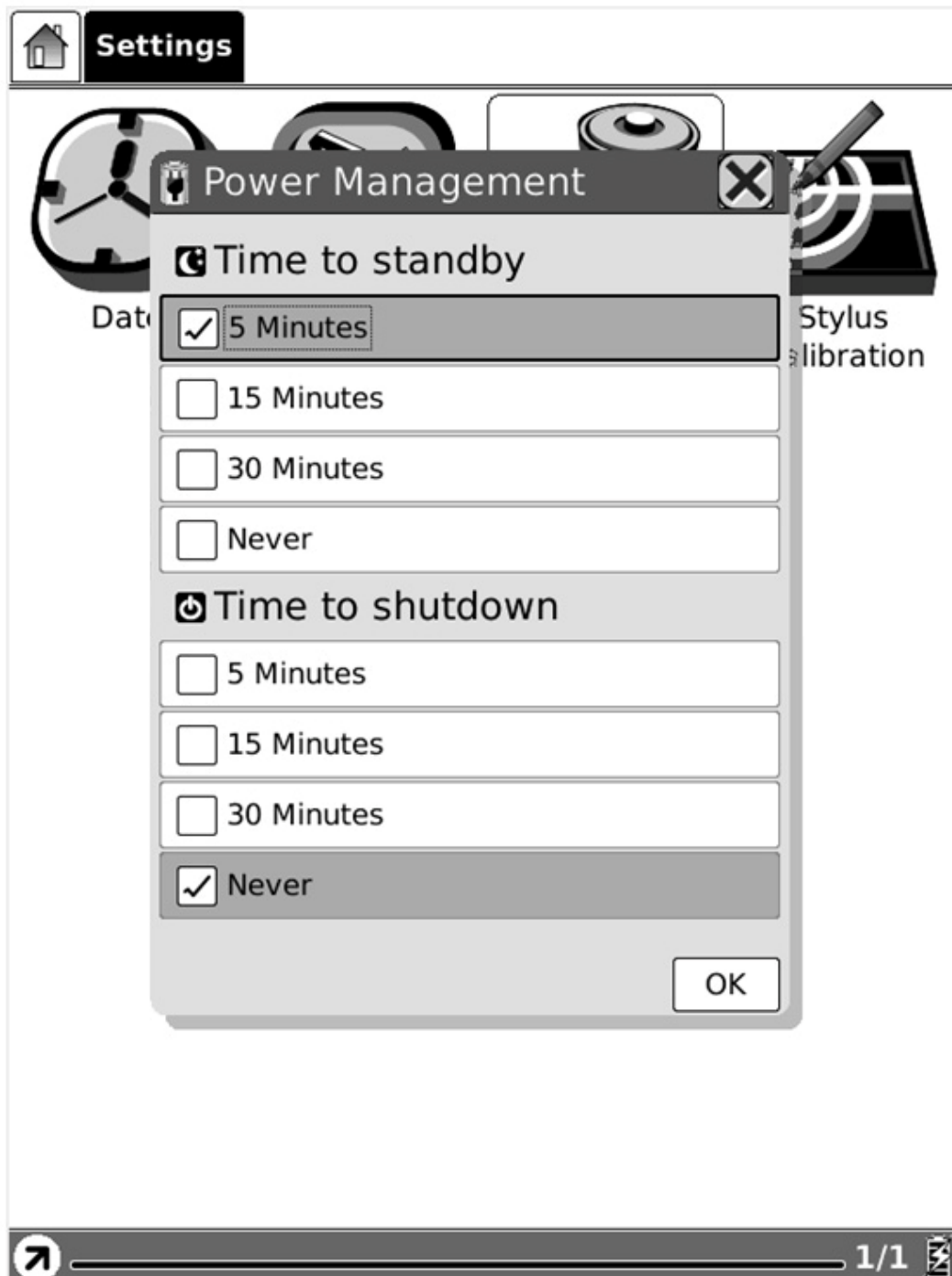

Fig. 7.1.6.4 Power Management Dialog



7.1.6.5 Stylus Calibration

If the tip of your stylus does not match with the position on the screen, you can improve the precision by stylus calibration.

+

**Please press once at each of the marks
shown in the screen.**

Fig. 7.1.6.5 (1) Initial Screen of Stylus Calibration

Follow the guideline displayed on the screen: 'Please press once at each of the marks shown on the screen'. After you click on the center of the mark, the screen will refresh and you will be asked to do the same action for the next points.

**Please press once at each of the marks
shown in the screen.**

+

Fig. 7.1.6.5 (2) Snapshot of Step 1

**Please press once at each of the marks
shown in the screen.**

+

Fig. 7.1.6.5 (3) Snapshot of Step 2

+

**Please press once at each of the marks
shown in the screen.**

Fig. 7.1.6.5 (4) Snapshot of Step 3

**Please press once at each of the marks
shown in the screen.**

+

Fig. 7.1.6.5 (5) Snapshot of Step 4



7.1.6.6 Format Flash

Select Format Flash button in settings, you can format the internal flash. Note, after doing this operation all of the data in internal flash will be removed.

Use at your own risk. We are not responsible for any data lost after performing this procedure.



Fig. 7.1.6.6 Snapshot of Formatting Flash



7.1.6.7 About

Select About button to see the information of BeBook Neo and firmware information.



The BeBook Neo is a product of Endless Ideas BV, the Netherlands. For additional information, accessories or enquiries, please visit our website : www.mybebook.com

Firmware Version: 1.2.2 20100118

Device serial number: {1766e65c-68b0-4964-a298-f74670f282e5}

Waveform information: V110_B030_60_WE1602_BTC



Fig. 7.1.6.7 Snapshot of About Dialog



7.1.6.8 Licenses

Select Licenses button to see the detailed license information of all open-source projects used by BeBook Neo.

Open Source Software Notice

This product includes certain open source software originating from third parties, which is subject to different and/or additional licenses, disclaimers and notices. The source code of such open source software and the exact terms of said licenses, disclaimers, acknowledgments and notices are available at

<http://mybebook.com/forum/viewforum.php?f=1>

All source code is available at no cost for download at our website:

<http://mybebook.com/forum/viewforum.php?f=1>

In addition a request for a copy of the source code on CD ROM /SD card may be requested at info@mybebook.com. You will be charged a service fee for this offer.

GNU GENERAL PUBLIC LICENSE

Version 2, June 1991

Copyright (C) 1989, 1991 Free Software Foundation, Inc.

51 Franklin Street, Fifth Floor, Boston, MA 02110-1301, USA

Everyone is permitted to copy and distribute verbatim



Fig. 7.1.6.8 Snapshot of Licenses



7.1.7 Websites

BeBook Neo provides entries to access the most common websites.

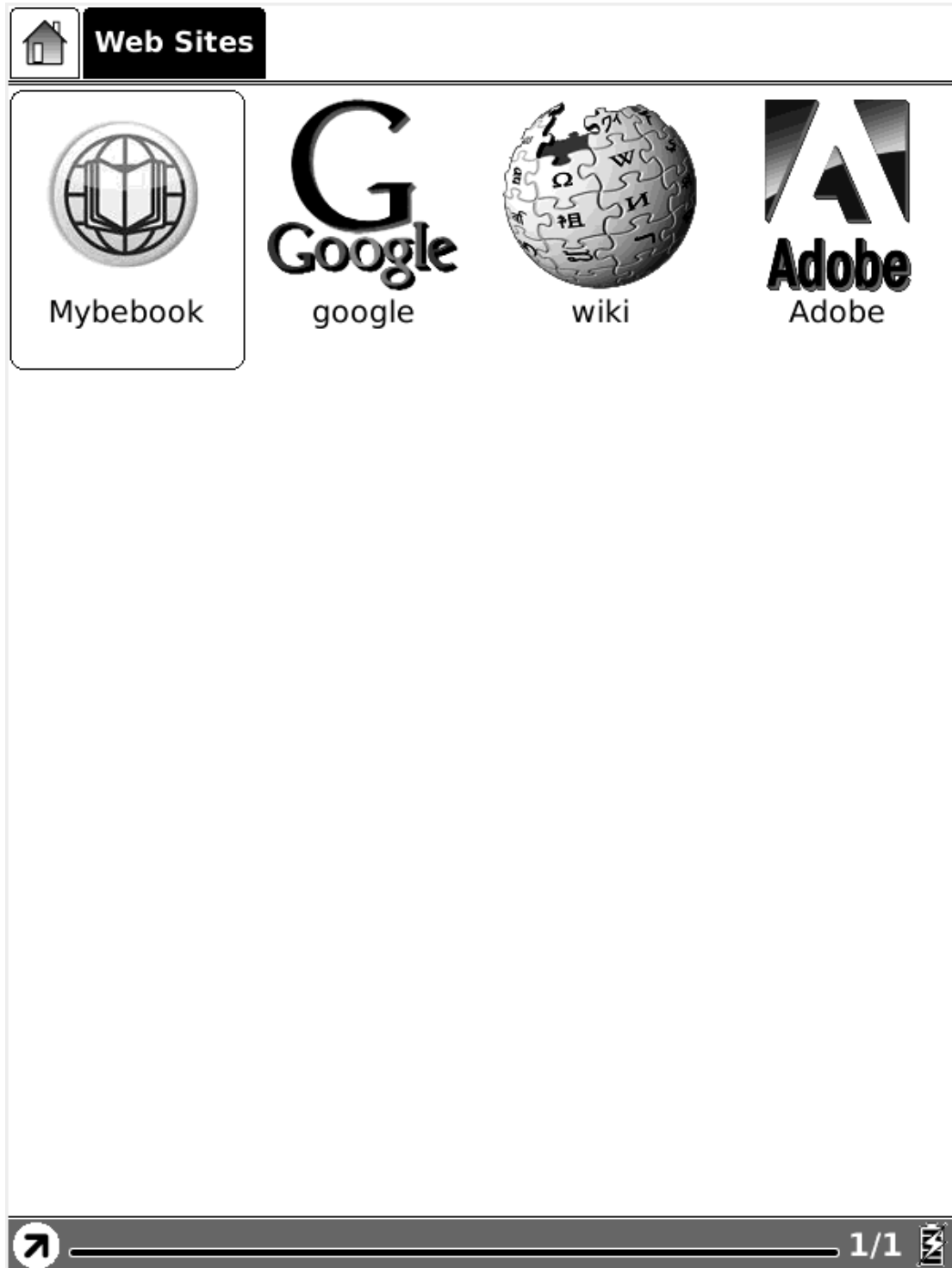

Fig. 7.1.7 Common Websites

7.2 Navigation Bar

Navigation bar displays the path of folders. Each folder in this path is displayed as a button. You can jump into any parent folder by clicking the button.

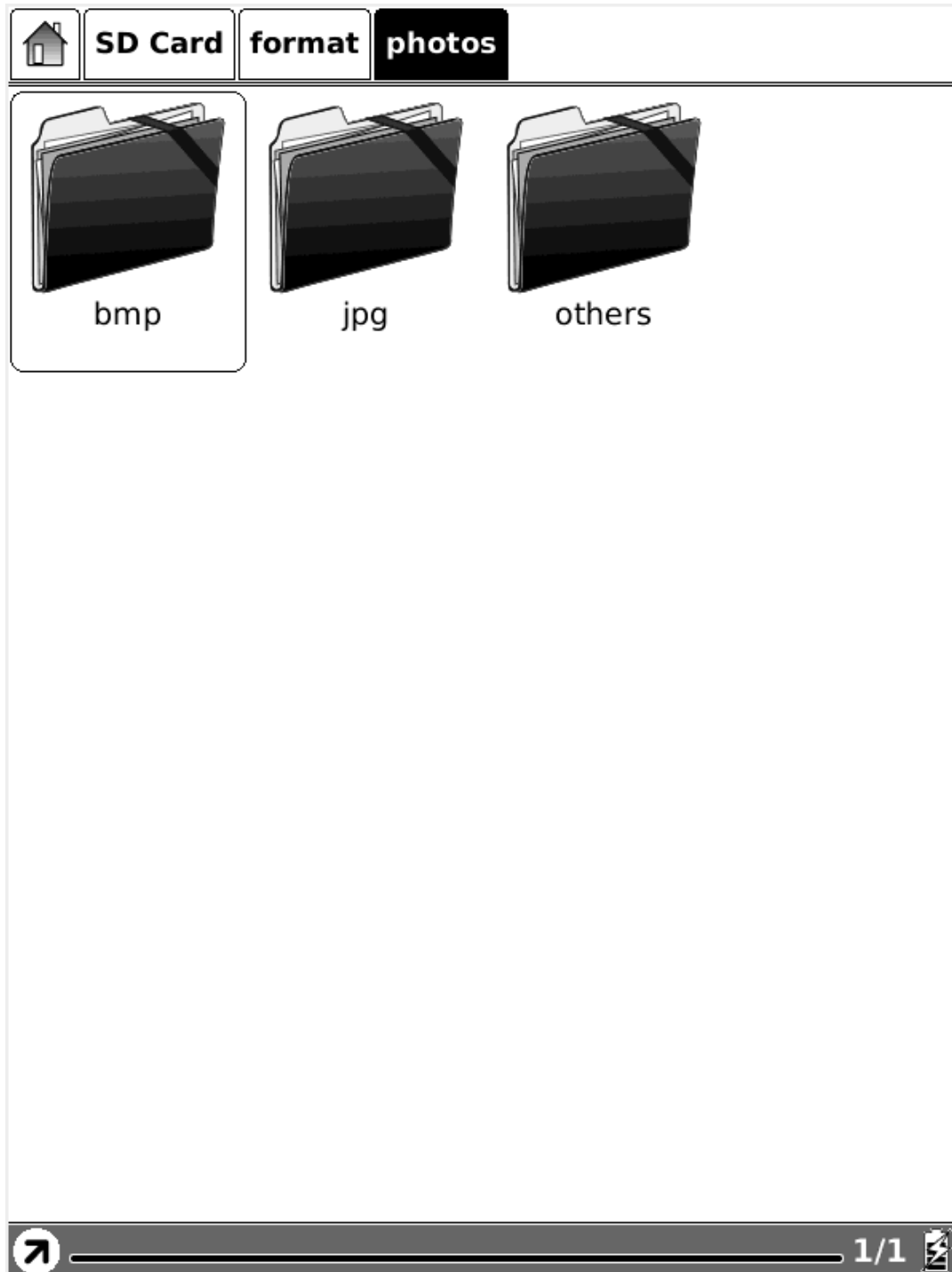

Fig. 7.2 Snapshot of Navigation Bar

7.3 Tool Bar

Tool Bar shows you information about the current screen. This information can include Menu Button, Progress Bar to show progress in a book or progress in loading a website and battery status.

7.3.1 Menu Button

Select the Menu button then the menu pops up. Most of the operations to BeBook Neo can be done by accessing the menu.



Fig. 7.3 Snapshot of Tool Bar

7.3.2 Progress Bar

Progress bar displays the reading progress of viewing documents. The number of the current page and the total pages of the document are displayed on the right of the progress bar. Clicking or dragging on the progress bar leads to flipping screens.

appeared; but consider how much it must increase his disappointment!"

"Indeed," replied Elizabeth, "I am heartily sorry for him; but he has other feelings, which will probably soon drive away his regard for me. You do not blame me, however, for refusing him?"

"Blame you! Oh, no."

"But you blame me for having spoken so warmly of Wickham?"

"No--I do not know that you were wrong in saying what you did."

"But you will know it, when I tell you what happened the very next day."

She then spoke of the letter, repeating the whole of its contents as far as they concerned George Wickham. What a stroke was this for poor Jane! who would willingly have gone



Fig. 7.3.2 (1) Snapshot of Progress Bar while Viewing Document

Progress bar displays the progress of viewing contents in main view. The number of the current screen and the total screens are displayed on the right of the progress bar.

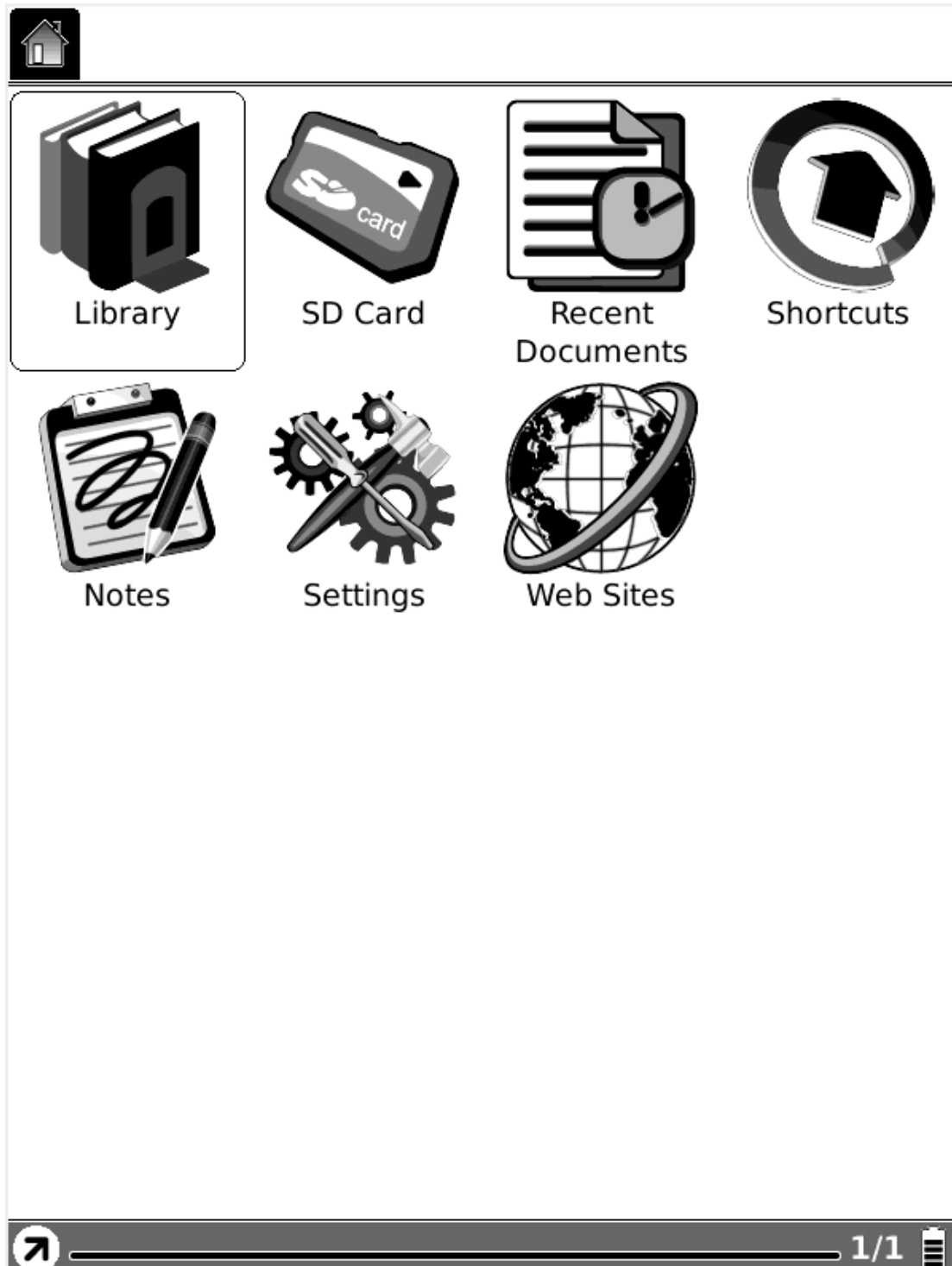

Fig. 7.3.2 (2) Snapshot of Progress Bar in Main View

Progress bar displays the progress (in ratio) of loading a website.

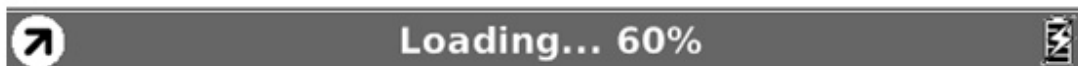

Fig. 7.3.2 (3) Snapshot of Progress Bar while Loading Website

Progress bar displays the relative position of current viewport while viewing a website. Clicking or dragging on the progress bar leads to moving the viewport.



Fig. 7.3.2 (4) Snapshot of Progress Bar while Viewing Website

7.3.3 Stylus Indicator

The stylus indicator is shown while viewing PDF(DRM)/EPub(DRM)/Image document.



7.3.3.1 Sketch

This icon appears when device enters sketch status. You can sketch on the drawing area of the screen.



7.3.3.2 Erase Sketches

This icon appears when device enters erasing sketch status. You can erase the sketches displayed on screen. If the pen hits the notes, the notes disappear immediately.



7.3.3.3 Hand Tool

This icon appears when device enters dragging status. You can drag the content by stylus as using the hand.



7.3.3.4 Selection Zoom

This icon appears when device enters selection zoom status. You can zoom in the content you are interested by stylus. A box appears following the track of the pen, then the area of the box would be zoomed in to fit the screen.



7.3.3.5 Annotate

This icon appears when device enters annotation status. You can take annotations on the text-based content. The annotated texts are highlighted following the track of the pen.



7.3.3.6 Erase Annotations

This icon appears when device enters erasing annotation status. You can erase the annotations displayed on screen by stylus. If the pen hits the highlighted texts, the highlighting effect on these texts disappears.



7.3.3.7 Power Indicator

Power indicator shows current status of the battery.



7.3.3.8 Clock

The current time as well as the reading time is displayed if you click on the clock located on the toolbar.

Contents

1	I Meet Sir Henry Curtis	11
2	The Legend of Solomon's Mines	24
3	Umbopa Enters Our Service	38
4	An Elephant	54
5	Our Mission	67
6	Water!	86
7	Solomon's Mines	102
8	We Enter the Mines	125
9	Twala's Story	137
10	The Witch-Hunt	155
11	We Give A Sign	174
12	Before The Battle	193
13	The Attack	208
14	The Last Stand of the Greys	221
15	Good Falls Sick	245
16	The Place of Death	260

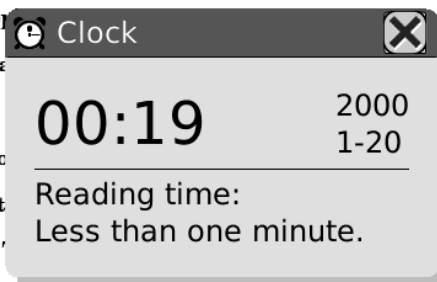

Fig. 7.3.3.8 Snapshot of Clock

7.4 Menu



7.4.1 Screen Rotation

Rotate the screen by clicking this button. The screen rotates between 0° and 270° (counterclockwise).



7.4.2 Save Remove SD Card

Safely remove SD card from BeBook Neo by clicking this button.



7.4.3 Standby

Turn BeBook Neo into standby status by clicking this button. Once standby, BeBook Neo stops working and the screen saver (pictures) appears. BeBook Neo consumes very little power while standing by. Pressing any key can wake up the device from standby status.



7.4.4 Shutdown

Shut down BeBook Neo by clicking this button.



7.4.5 View

View means the way of displaying and arranging contents in main view.



7.4.5.1 List View

Display the contents by listing. The name, type, size and last access time of the document are displayed.











Name ▲		Type	Size	Last Access
	bin	Folder		2010-01-22 00:00
	dicts	Folder		2010-01-22 00:00
	downloads	Folder		2010-01-22 00:00
	ebooks	Folder		2010-01-22 00:00
	fonts	Folder		2010-01-22 00:00
	format	Folder		2010-01-22 00:00
	manual	Folder		2010-01-22 00:00
	notes_template	Folder		2010-01-22 00:00
	picture	Folder		2010-01-22 00:00
	snapshot	Folder		2000-01-17 07:21

Fig. 7.4.5.1 Snapshot of List View

☰ :
☰ :
☰ : **7.4.5.2 Details View**

Display the contents in details. The details includes name, last access time, read count and reading progress.

Recent Documents

	<p>licenses.txt</p> <p>Last Access: 2010-01-20 10:03</p> <p>Read count: 1</p> <p>Progress: 1 / 64</p>	<p>★★★★★</p> <p>65KB</p>
	<p>en_US.pdf</p> <p>Last Access: 2009-08-24 10:38</p> <p>Read count: 9</p> <p>Progress: 13 / 128</p>	<p>★★★★★</p> <p>2.4MB</p>
	<p>snapshot_1.png</p> <p>Last Access: 2009-08-24 00:00</p> <p>Read count: 2</p> <p>Progress: 1 / 1</p>	<p>★★★★★</p> <p>0Bytes</p>

1/1

7.4.5.2 Snapshot of Details View



7.4.5.3 Thumbnail View

Display the contents in thumbnails. For image format (including JPEG/BMP/PNG/...), the thumbnail of image is displayed. For other document format, the large icon of the format is displayed.

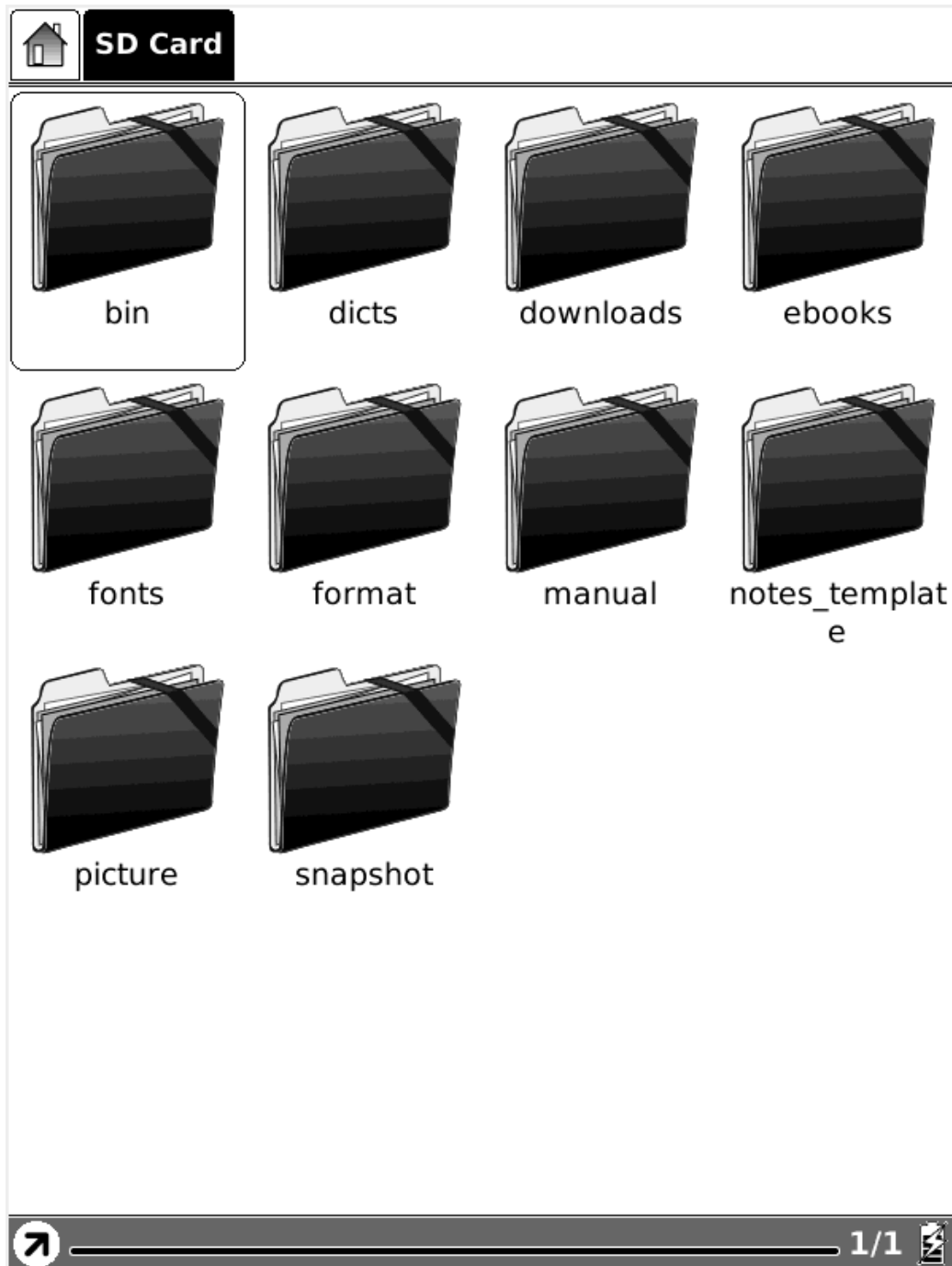













Fig. 7.4.5.3 Snapshot of Thumbnail View



7.4.5.4 By Name

Sort the contents in current directory by name.

 SD Card				
Name	▲	Type	Size	Last Access
 bin		Folder		2010-01-22 00:00
 dicts		Folder		2010-01-22 00:00
 downloads		Folder		2010-01-22 00:00
 ebooks		Folder		2010-01-22 00:00
 fonts		Folder		2010-01-22 00:00
 format		Folder		2010-01-22 00:00
 manual		Folder		2010-01-22 00:00
 notes_template		Folder		2010-01-22 00:00
 picture		Folder		2010-01-22 00:00
 snapshot		Folder		2000-01-17 07:22



1/1 

Fig. 7.4.5.4 Snapshot of Sorting the Contents in Current Directory by Name



7.4.5.5 By Type

Sort the contents in current directory by document type.

SD Card			
Name	Type ▲	Size	Last Access
bin	Folder		2009-08-18 00:00
dicts	Folder		2009-09-12 00:00
documents	Folder		2009-07-10 00:00
downloads	Folder		2009-08-17 00:00
fonts	Folder		2009-09-13 22:01
format	Folder		2009-07-10 00:00
pictures	Folder		2009-08-18 00:00
snapshot	Folder		2009-09-13 22:08

1 / 1

Fig. 7.4.5.5 Snapshot of Sorting the Contents in Current Directory by Type



7.4.5.6 By Size

Sort the contents in current directory by document size.

SD Card			
Name	Type	Size▲	Last Access
bin	Folder		2010-01-22 00:00
dicts	Folder		2010-01-22 00:00
downloads	Folder		2010-01-22 00:00
ebooks	Folder		2010-01-22 00:00
fonts	Folder		2010-01-22 00:00
format	Folder		2010-01-22 00:00
manual	Folder		2010-01-22 00:00
notes_template	Folder		2010-01-22 00:00
picture	Folder		2010-01-22 00:00
snapshot	Folder		2000-01-17 07:23

Fig. 7.4.5.6 Snapshot of Sorting the Contents in Current Directory by Size



7.4.5.7 By Access Time

Sort the contents in current directory by access time.

SD Card			
Name	Type	Size	Last Access ▲
documents	Folder		2009-07-10 00:00
format	Folder		2009-07-10 00:00
downloads	Folder		2009-08-17 00:00
bin	Folder		2009-08-18 00:00
pictures	Folder		2009-08-18 00:00
dicts	Folder		2009-09-12 00:00
fonts	Folder		2009-09-13 22:01
snapshot	Folder		2009-09-13 22:08

1/1

Fig. 7.4.5.7 Snapshot of Sorting the Contents in Current Directory by Access Time



7.4.5.8 By Rating

Sort the contents in current directory by rating.

SD Card

	<p>bird4.png Last Access: 2009-09-15 00:00 Read count: 2 Progress: 1 / 1</p>	<p>★ ★ ★ ★ ★ 254KB</p>
	<p>bird3.png Last Access: 2009-09-15 00:00 Read count: 2 Progress: 1 / 1</p>	<p>★ ★ ★ ★ ★ 335KB</p>
	<p>bird2.png Last Access: 2009-09-15 00:00 Read count: 2 Progress: 1 / 1</p>	<p>★ ★ ★ ★ ★ 289KB</p>
	<p>AliceInWonderland.epub Last Access: 2000-01-10 00:00 Read count: 3 Progress: 14 / 75</p>	<p>★ ★ ★ ★ ★ 799KB</p>
	<p>bird1.png Last Access: 2009-09-15 00:00 Read count: 0 Progress: Not Read</p>	<p>★ ★ ★ ★ ★ 329KB</p>

7

3/3

⌂

Fig. 7.4.5.8 Snapshot of Sorting the Contents in Current Directory by Rating

7.4.5.9 Ascending

Sort the contents in current directory by ascending order.

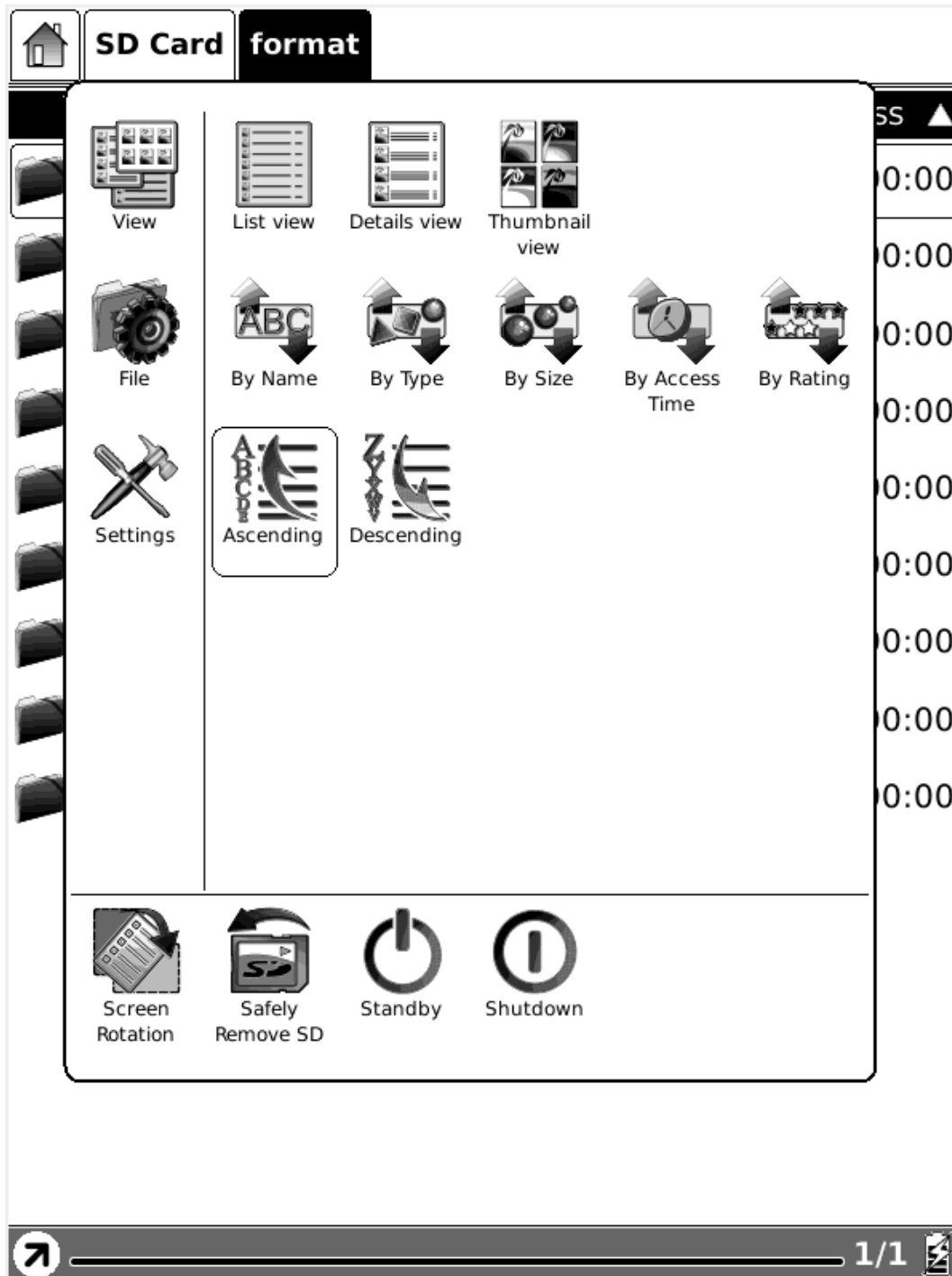

Fig. 7.4.5.9 Snapshot of Sorting Contents in Current Directory by Ascending Order

7.4.5.10 Descending

Sort the contents in current directory by descending order.

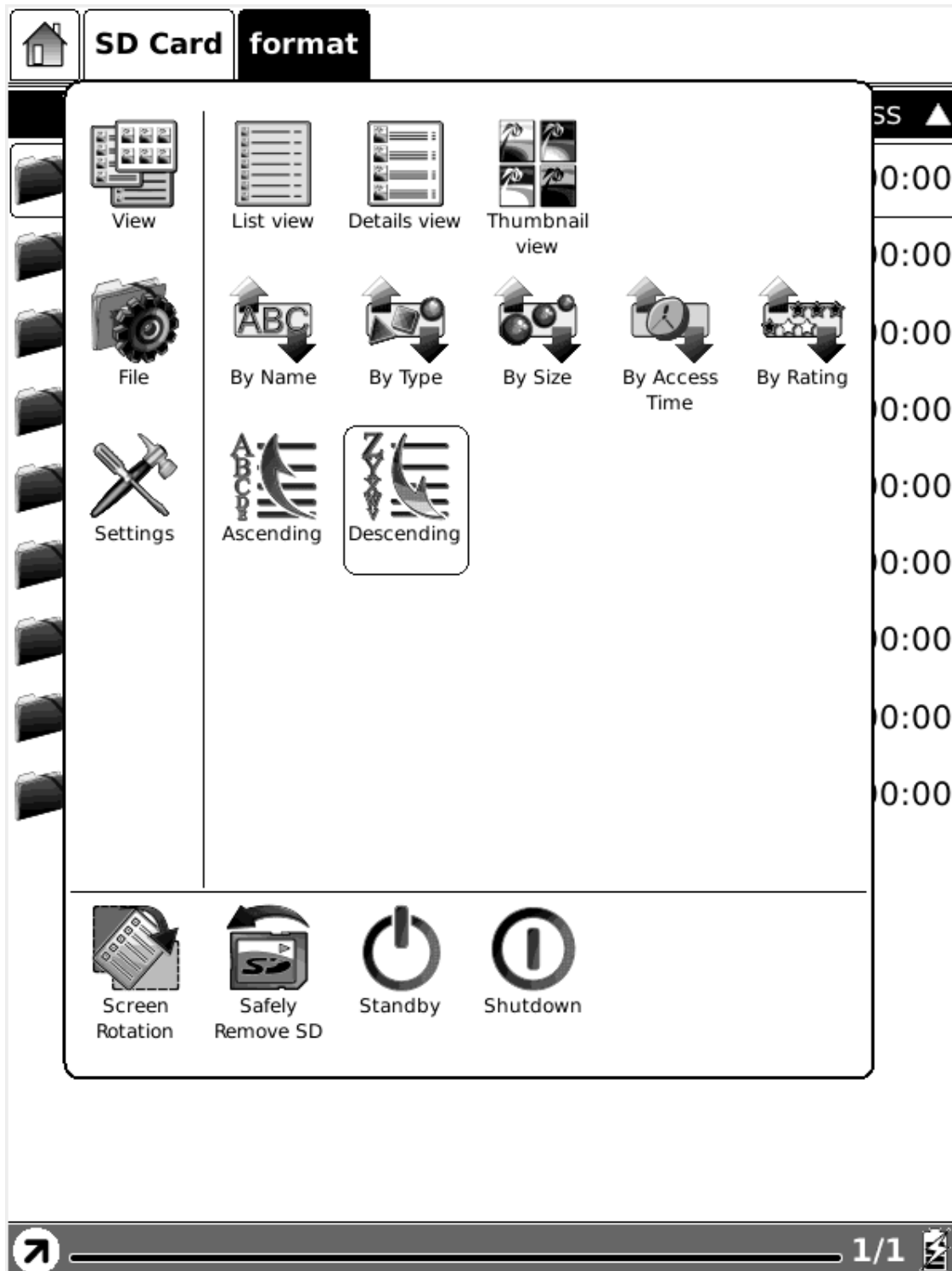

Fig. 7.4.5.10 Snapshot of Sorting Contents in Current Directory by Descending Order



7.4.6 File

File means the operations to a file.



7.4.6.1 Delete

Delete a selected file.

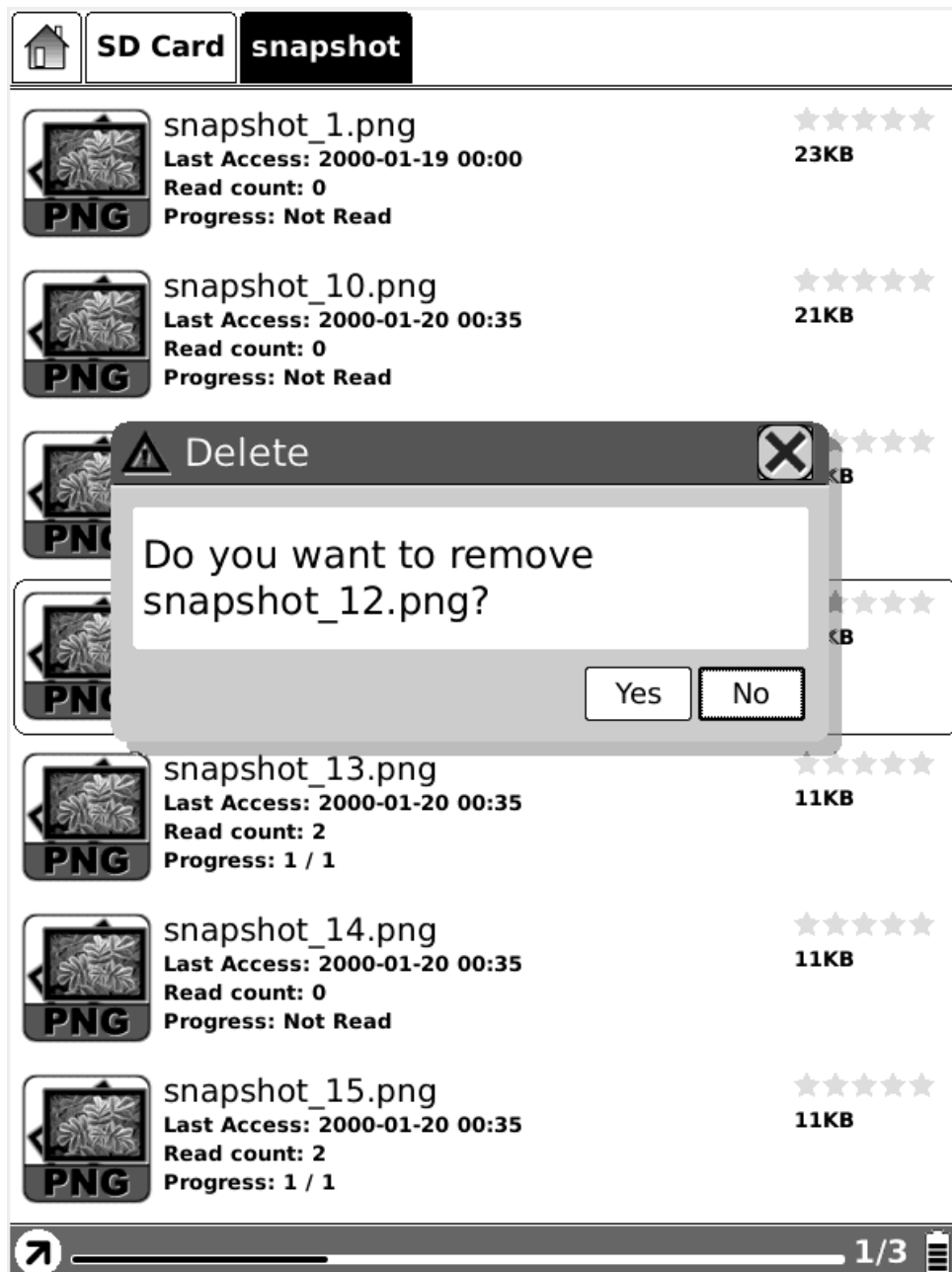

Fig. 7.4.6.1 Delete a Selected File



7.4.6.2 Search

Search for target file by given pattern. The search results are displayed in the main view.



Fig. 7.4.6.2 (1) Search Files by Given Pattern



Fig. 7.4.6.2 (2) Search Results



7.4.6.3 Create shortcut

Create shortcut on a selected file. Once the shortcut is created, you can find and open the file in shortcuts view. You can create a shortcut for given 3rd-party applications or documents by follow steps:

1. Select the file by direction key

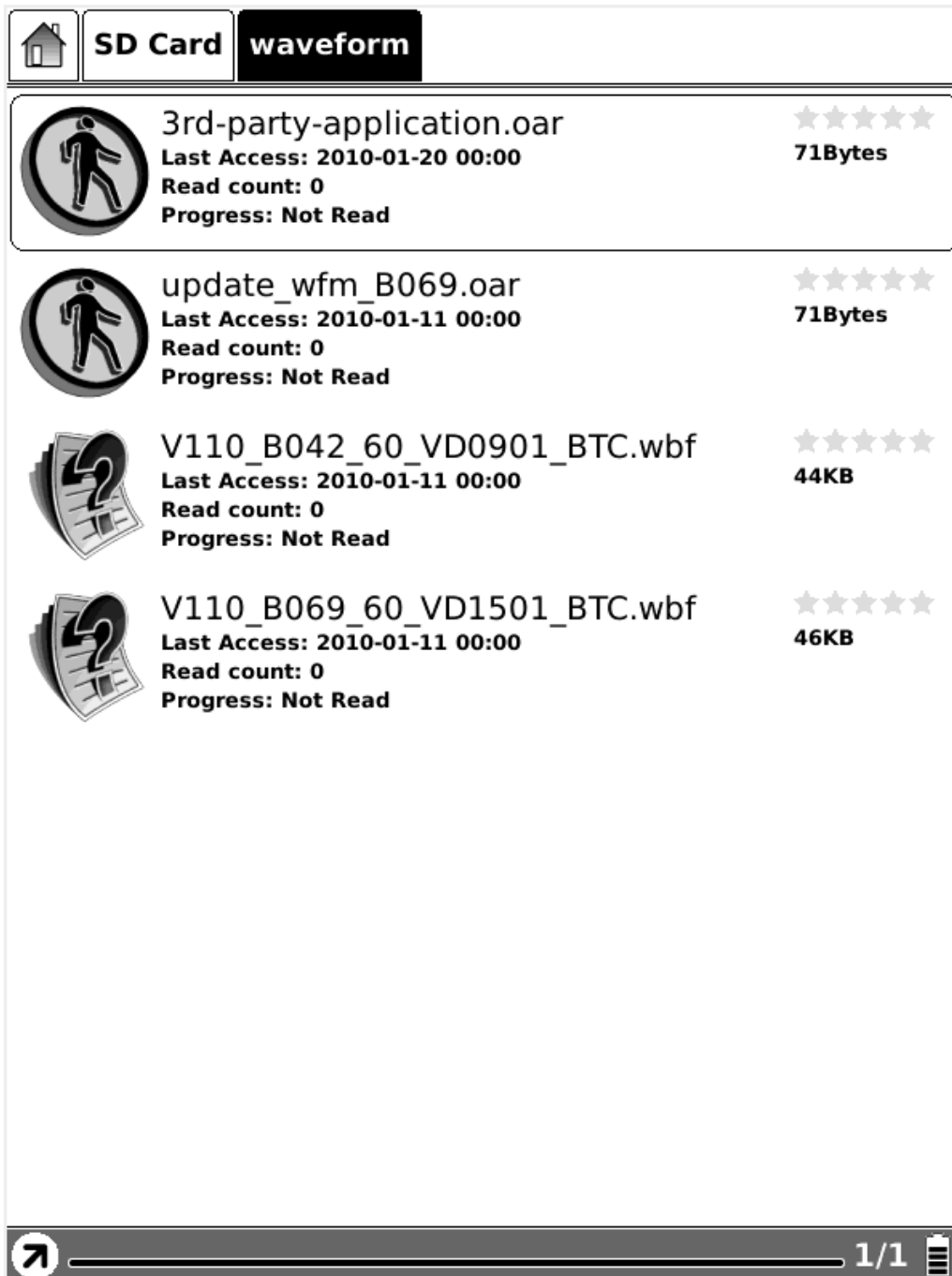

Fig 7.4.6.3 (1) Select 3rd-party application

2. Popup menu and click function Create shortcut in File category

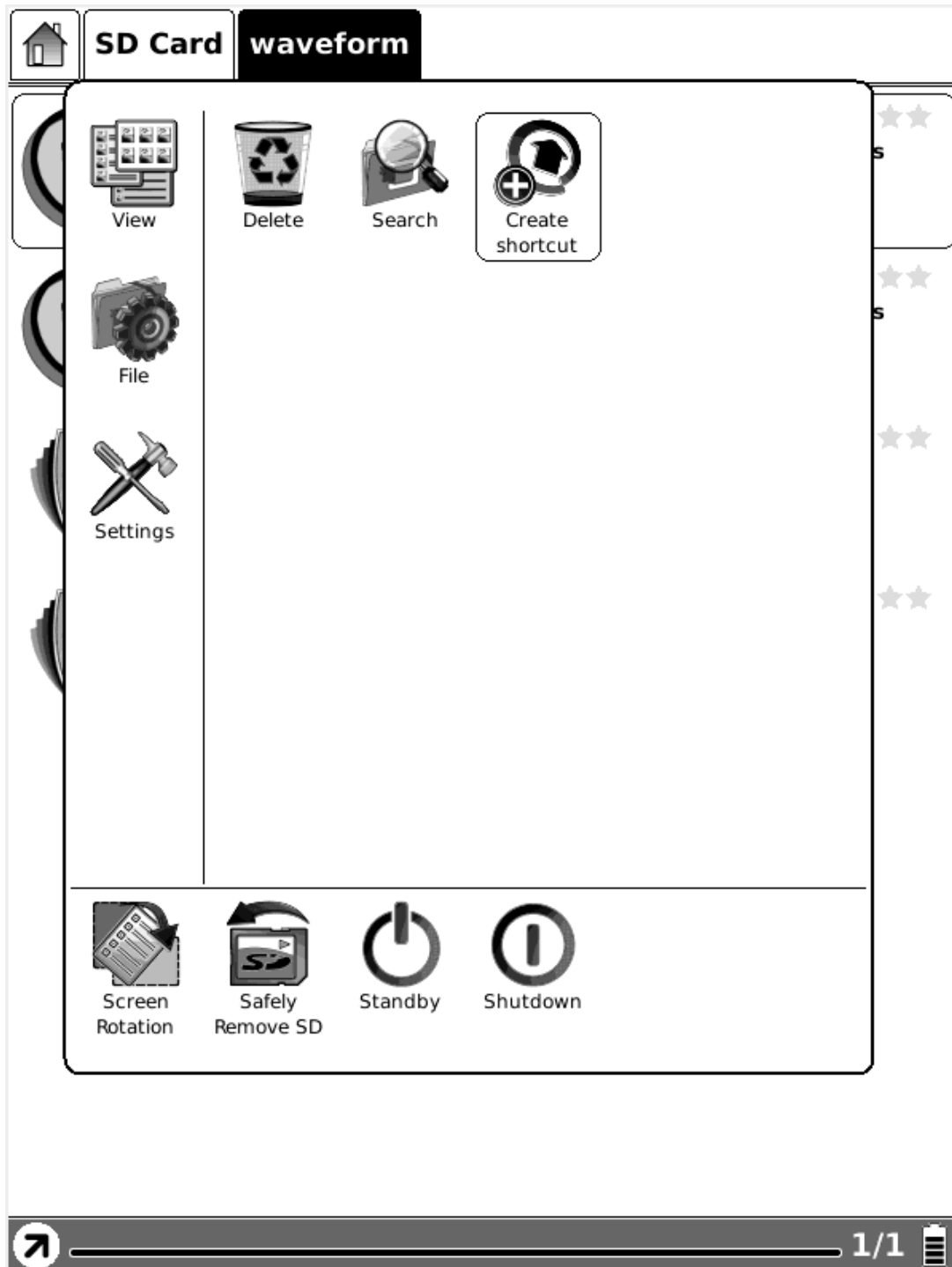

Fig 7.4.6.3 (2) Select function Create shortcut

3. Turn to Shortcuts view, you will find the shortcut of that application.

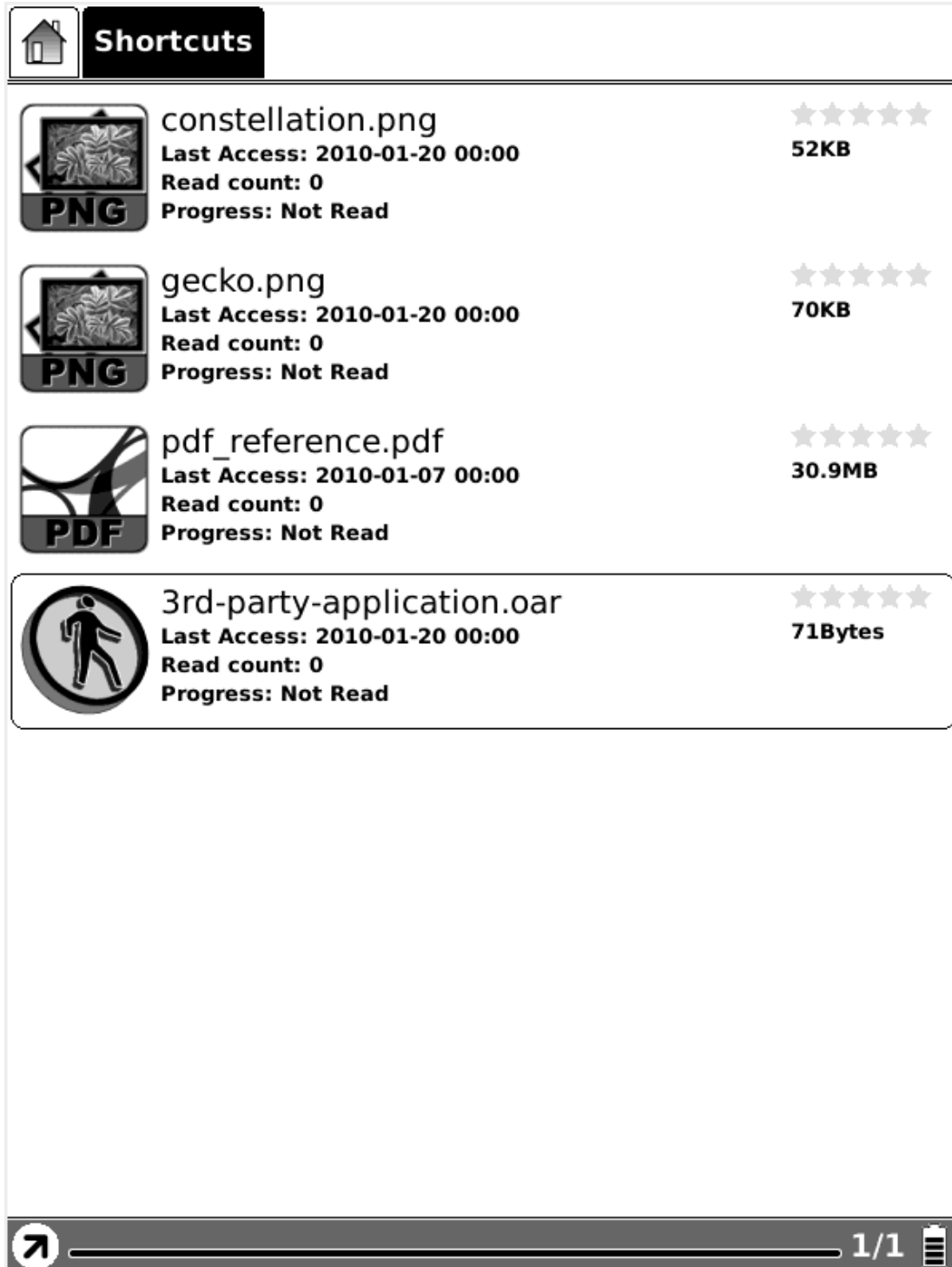

Fig 7.4.6.3 (3) Created shortcut in Shortcuts view



7.4.6.4 Return Book

Return borrowed book.

Note: The WiFi configuration dialog pops up after you decide to return a borrowed book (the WiFi is only opened when it is necessary). The returning starts after the configuration succeeds.



7.4.7 Settings

Settings in menu is identical with the Settings button in main view. Please refer to [7.1.4](#) for details.



7.4.7.1 Date Settings

Configure the date and time of device, as the same as [7.1.4.1](#).



7.4.7.2 Locale Settings

Configure the device language, as the same as [7.1.4.2](#).



7.4.7.3 Power Management

Configure the time of standby and automatically shutdown, as the same as [7.1.4.3](#).



7.4.7.4 Screen Calibration

Enter the screen calibration application, as the same as [7.1.4.4](#).



7.4.7.5 Format Flash

Format the internal flash, as the same as [7.1.4.5](#).



7.4.7.6 About

Display the information of the device, as the same as [6.1.4.6](#).



7.4.8 Font

Configure the font size and/or shape while viewing document.

7.4.8.1 By Levels

Configure the font size by several font levels: small, medium, large, larger and largest. This function is activated while viewing PDF/Epub document.

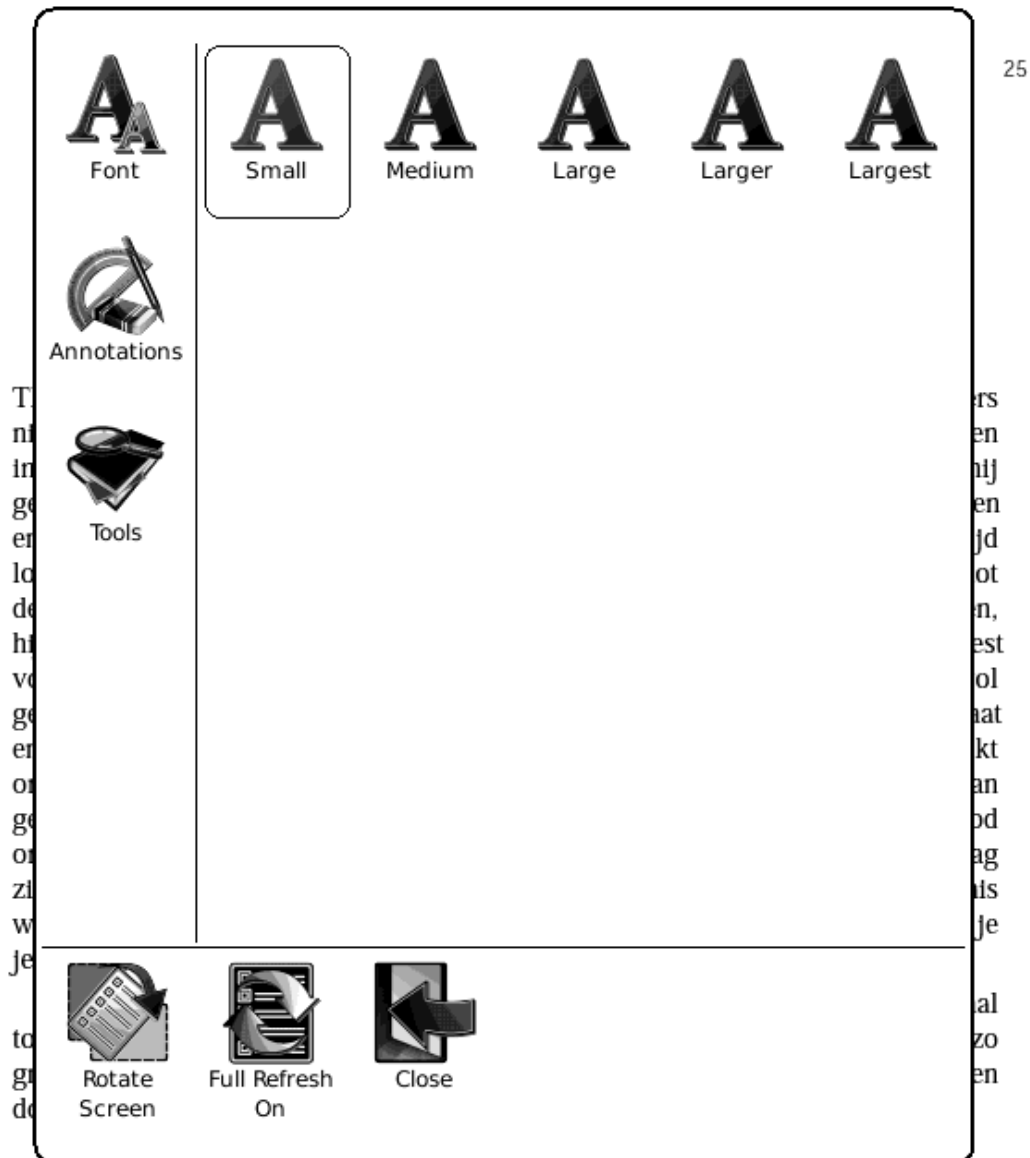

Thomas schrok op toen hij op de trap het geluid van snelle voetstappen hoorde. De man van Suite Cleopatra holde de trap af in de richting van de garagedeur en

Fig. 7.4.8.1 Configure the Font Size by Levels

7.4.8.2 By Numbers

Configure the font size by actually number. This function is activated while viewing TXT/Mobi(non-drm)/RTF/PDB document.

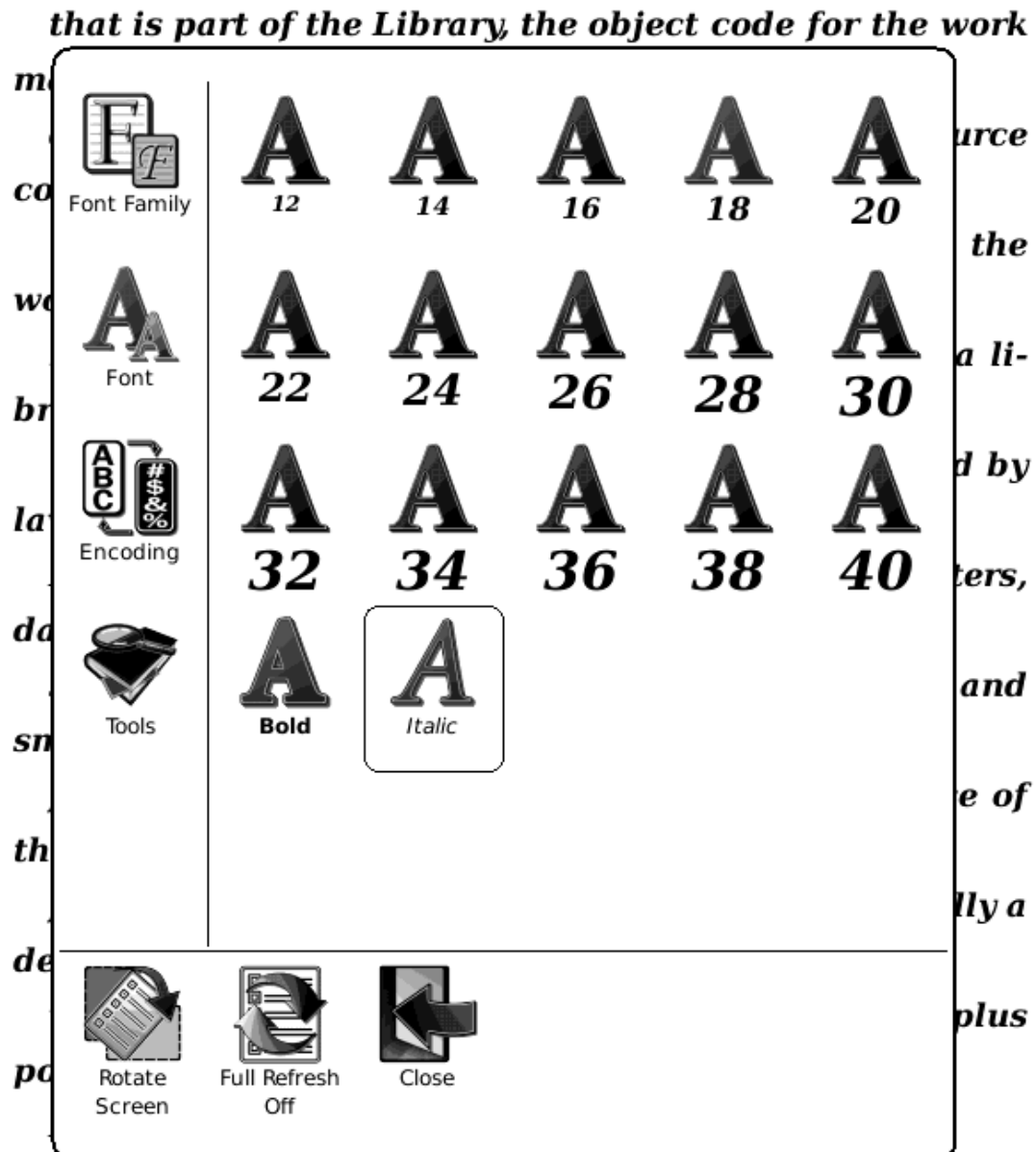

Otherwise, if the work is a derivative of the Library, you may

Fig. 7.4.8.2 Configure the Font Size by Numbers

7.4.8.3 By Ratio

Configure the font size by ratio. This function is activated while viewing HTML/CHM document.

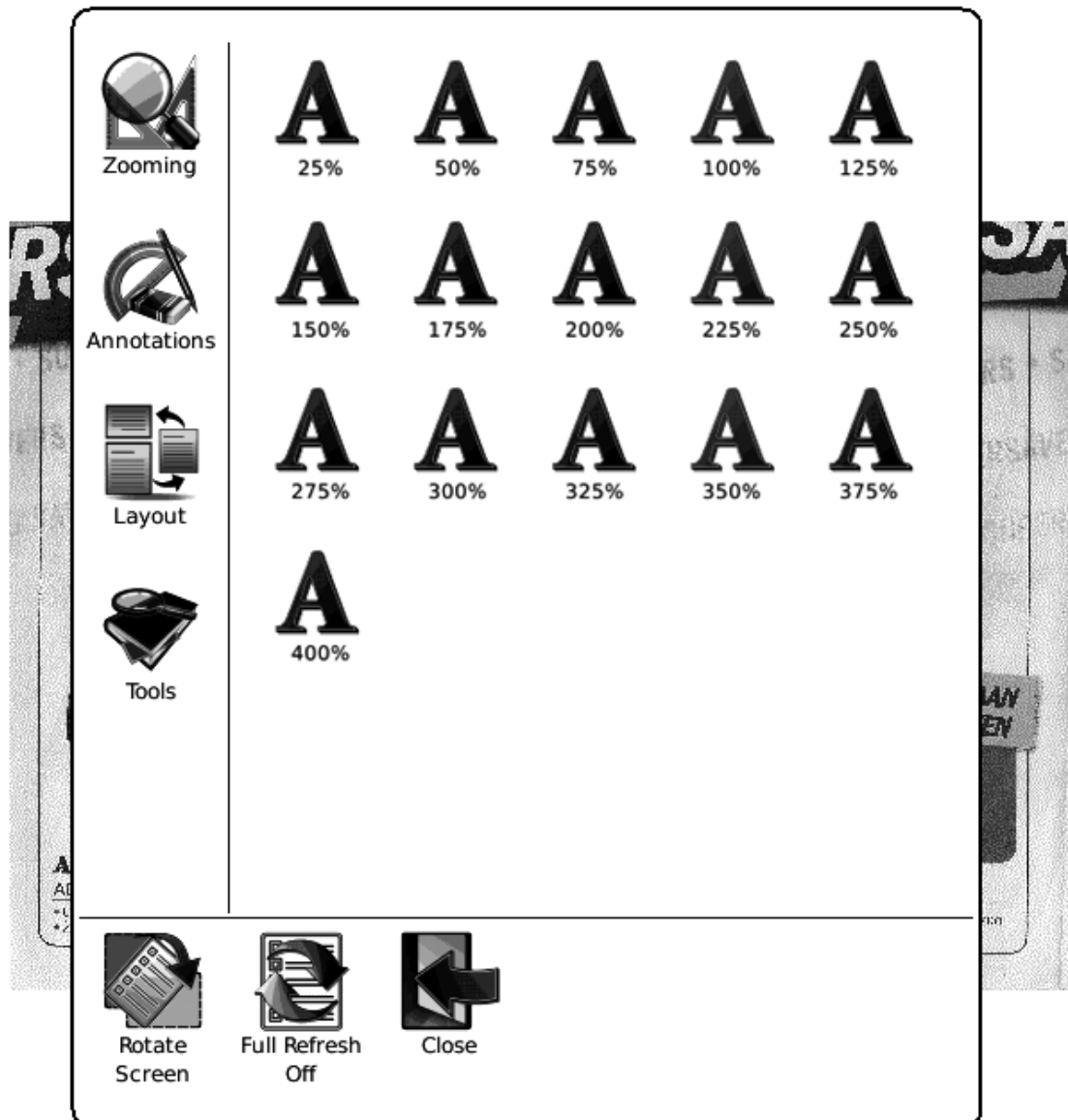

Fig. 7.4.8.3 Configure the Font Size by Ratio

7.4.8.4 Bold

Set the font bold.

that is part of the Library, the object code for the work

The screenshot shows a font configuration window with the following sections:

- Font Family:** A grid of 'A' characters in sizes 12, 14, 16, 18, and 20.
- Font:** A grid of 'A' characters in sizes 22, 24, 26, 28, and 30.
- Encoding:** A grid of 'A' characters in sizes 32, 34, 36, 38, and 40.
- Tools:** Two 'A' characters, one in **Bold** and one in *Italic*. The **Bold** option is highlighted with a rounded rectangle.
- Bottom Bar:** Three icons labeled 'Rotate Screen', 'Full Refresh Off', and 'Close'.

Otherwise, if the work is a derivative of the Library, you may

Fig. 7.4.8.4 Configure the Font to be Bold

7.4.8.5 Italic

Set the font italic.

that is part of the Library, the object code for the work

The screenshot shows a font configuration window with the following sections:

- Font Family:** Five 'A' characters in different sizes (12, 14, 16, 18, 20).
- Font:** Five 'A' characters in different sizes (22, 24, 26, 28, 30).
- Encoding:** Five 'A' characters in different sizes (32, 34, 36, 38, 40).
- Tools:** Two 'A' characters, one labeled 'Bold' and one labeled 'Italic'. The 'Italic' option is highlighted with a rounded rectangle.
- Bottom Bar:** Three icons: 'Rotate Screen', 'Full Refresh Off', and 'Close'.

source
work
rary.
d by
data
and
f the
lly a
por-
you

may

distribute the object code for the work under the terms of

Fig. 7.4.8.5 Configure the Font to be Italic



7.4.9 Zooming

Adjust the zoom of current screen. The screen can be scaled by fixed value (such as zooming to page, 75%, 200%). The screen can also be scaled up by given stylus box(selection zoom).



7.4.9.1 To Page

Zoom the current page/image to fit the screen.

Fig. 7.4.9.1 Snapshot of Zooming to Page



7.4.9.2 To Width

Zoom the current page/image to fit the width of screen.

Fig. 7.4.9.2 Snapshot of Zooming to Width



7.4.9.3 To Height

Zoom the current page/image to fit the height of screen.

Fig. 7.4.9.3 Snapshot of Zooming to Height



7.4.9.4 Selection Zoom

Scale up the current screen by selecting a box. The content in the selected box is enlarged to fill the whole drawing area.

appeared; but consider how much it must increase his disappointment!"

"Indeed," replied Elizabeth, "I am heartily sorry for him; but he has other feelings, which will probably soon drive away his regard for me. You do not blame me, however, for refusing him?"

"Blame you! Oh, no."

"But you blame me for having spoken so warmly of Wickham?"

"No--I do not know that you were wrong in saying what you did."

"But you will know it, when I tell you what happened the very next day."

She then spoke of the letter, repeating the whole of its contents as far as they concerned George Wickham. What a stroke was this for poor Jane! who would willingly have gone



Fig. 7.4.9.4 (1) Snapshot of Selection Zoom

appeared; but consider how much it must increase his disappointment!"

"Indeed," replied Elizabeth, "I am heartily sorry for him; but he has other feelings, which will probably soon drive away his regard for me. You do not blame me, however, for refusing him?"

"Blame you! Oh, no."

"But you blame me for having spoken so warmly of Wickham?"

"No--I do not know that you were wrong in saying what you did."

"But you will know it, when I tell you what happened the very next day."

She then spoke of the letter, repeating the

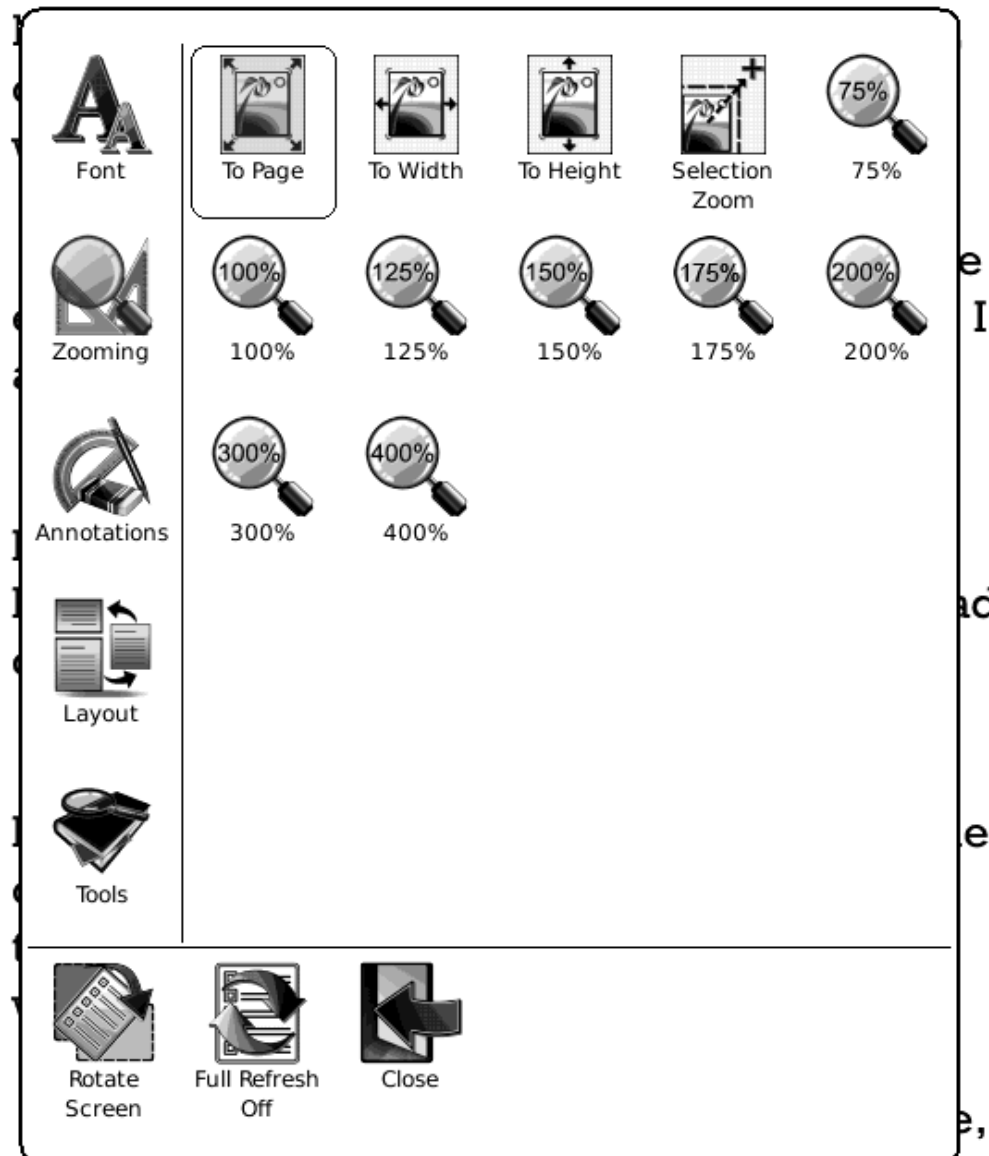

Fig. 7.4.9.4 (2) Snapshot of the Render Result after Selection Zoom

7.4.9.5 By Ratio

Zoom the current page/image by ratio.

concluded. She always made a bargain for it,



miss, I should think," retorted Jerry, "whether they drink your health or the Old Un's."



Fig. 7.4.9.5 Snapshot of Zooming by Ratio



7.4.10 Annotations

Annotations means a group of annotation operations, including annotating and sketching.



7.4.10.1 Add Annotation

Take annotation on the text of current screen. The annotated texts are highlighted.

appeared; but consider how much it must increase his disappointment!"

"Indeed," replied Elizabeth, "I am heartily sorry for him; but he has other feelings, which will probably soon drive away his regard for me. You do not blame me, however, for refusing him?"

"Blame you! Oh, no."

"But you blame me for having spoken so warmly of Wickham?"

"No--I do not know that you were wrong in saying what you did."

"But you will know it, when I tell you what happened the very next day."

She then spoke of the letter, repeating the whole of its contents as far as they concerned George Wickham. What a stroke was this for poor Jane! who would willingly have gone



Fig. 7.4.10.1 Snapshot of Adding Annotation



7.4.10.2 Erase Annotation

Erase annotation on current screen. The annotations are erased when you click on them or drag the stylus through them.

appeared; but consider how much it must increase his disappointment!"

"Indeed," replied Elizabeth, "I am heartily sorry for him; but he has other feelings, which will probably soon drive away his regard for me. You do not blame me, however, for refusing him?"

"Blame you! Oh, no."

"But you blame me for having spoken so warmly of Wickham?"

"No--I do not know that you were wrong in saying what you did."

"But you will know it, when I tell you what happened the very next day."

She then spoke of the letter, repeating the whole of its contents as far as they concerned George Wickham. What a stroke was this for poor Jane! who would willingly have gone

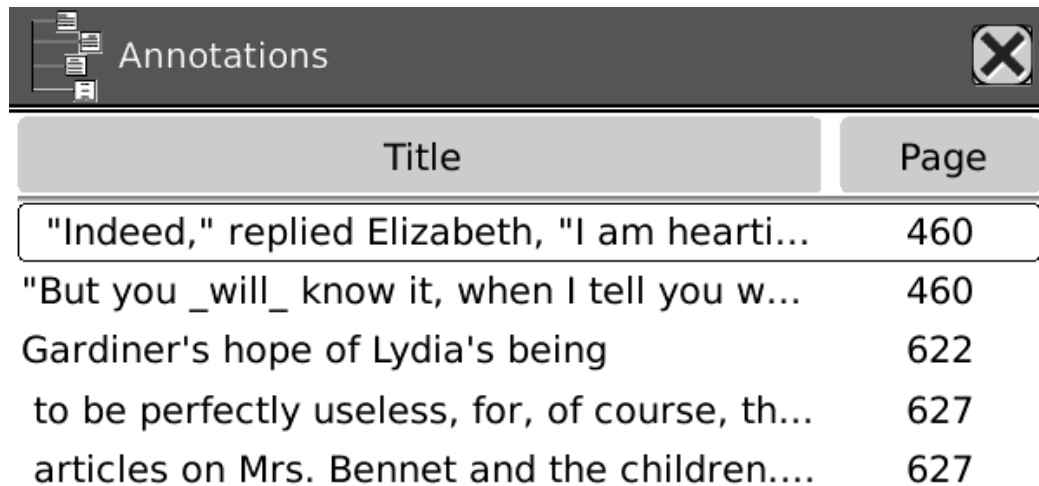

Fig. 7.4.10.2 Snapshot of Erasing Annotation

Title	Page
•Abcdefg...	1
•Hijklm...	2
•Nopqrst...	8
•Uvwxyz...	15

7.4.10.3 All Annotations

Display all of the annotations by list. The highlighted texts as well as the corresponding page numbers are displayed on the list view.



Annotations	
Title	Page
"Indeed," replied Elizabeth, "I am hearti...	460
"But you _will_ know it, when I tell you w...	460
Gardiner's hope of Lydia's being	622
to be perfectly useless, for, of course, th...	627
articles on Mrs. Bennet and the children....	627

Fig. 7.4.10.3 Display All Annotations



7.4.10.4 Sketch

Sketch on the content area of current screen by stylus.



7.4.10.4 Sketch on the Screen



7.4.10.5 Erase Sketch

Erase existing sketches by stylus. The sketches are erased when you click on them or drag the stylus through them.



7.4.10.6 Sketch Colors

Select the color of sketches. Now black and white are supported.

actual flight of stone steps, which wonderfully

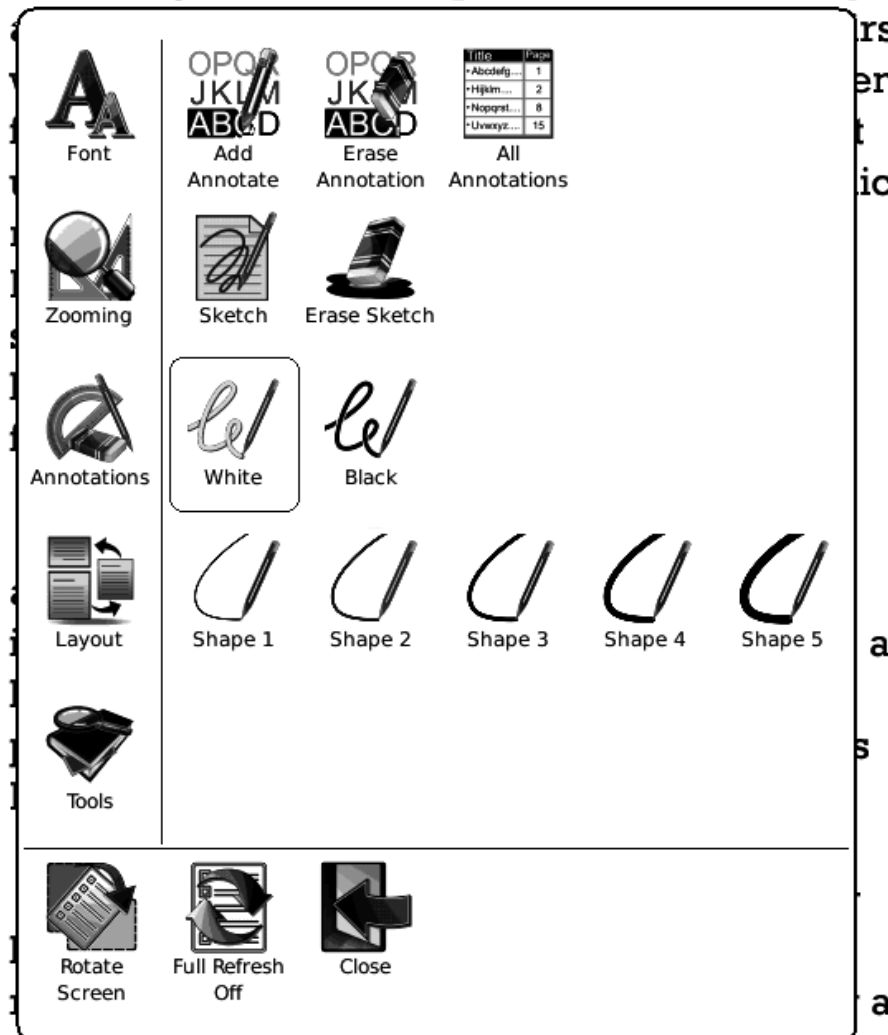

kind of spur or projection of the mountain--a sort of buttress upon which the conelike crater, properly so called, leaned for support.

Fig. 7.4.10.6 Sketch Colors



7.4.10.7 Sketch Shapes

Select the shape (line width) of sketches. Now five levels of line widths are supported.

actual flight of stone steps, which wonderfully

The interface includes the following tools and options:

- Font
- Add Annotate
- Erase Annotation
- All Annotations
- Zooming
- Sketch
- Erase Sketch
- Annotations
- White
- Black
- Layout
- Shape 1
- Shape 2 (Selected)
- Shape 3
- Shape 4
- Shape 5
- Tools
- Rotate Screen
- Full Refresh Off
- Close

kind of spur or projection of the mountain--a sort of buttress upon which the conelike crater, properly so called, leaned for support.

Fig. 7.4.10.7 Sketch Shapes



7.4.11 Layout

Select the layout of pages while viewing document.



7.4.11.1 Single Page

Only one page is displayed on screen.

Smart Direct Memory Access (SDMA)

The SDMA core is able to control and exchange data with these systems by sending instructions and reading or writing data from/to the functional units' registers via the FUBUS. This is done with the `ldf` and `stf` instructions.

The following sections provide introductions to the available functional units. Section 40.16, "Functional Units Programming Model" provides descriptions the functional units' behaviors.

40.6.1 CRC Calculation Unit

The Cyclic Redundancy Check (CRC) unit can perform CRC calculation. A single byte of data can be processed every cycle, but up to four bytes can be simultaneously loaded.

The CRC unit supports the following set of polynomials:

```

CRC32:  x32+x26+x23+x22+x16+x12+x11+x10+x8+x7+x5+x4+x2+x+1
CRC16:  x16+x15+x2+1
CCITT16: x16+x12+x5+1
IS136:  x12+x10+x8+x5+x4+x3+1
CRC10:  x10+x9+x5+x4+x+1
CRC8:   x8+x2+x+1
parity: x8+1
    
```

40.6.1.1 CRC Structure

Figure 40-9 describes the overall structure of the CRC unit and introduces its registers that are accessible by the SDMA core via the FUBUS.

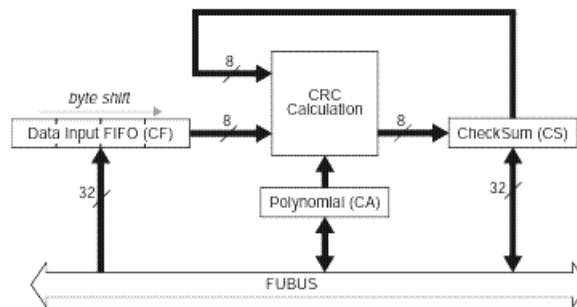

Figure 40-9. CRC Structure

40.6.1.2 CRC Data Processing

CRC processing requires the following three stages:

1. The preliminary initialization stage consists of selecting the desired polynomial, and storing the initialization pattern into the checksum register.

Fig. 7.4.11.1 Snapshot of Single Page



7.4.11.2 Scroll Pages

Multiple pages can be displayed on screen. If there are enough blanks besides one page on the screen, the parts of adjacent pages fill these blanks. There is a small spacing between two pages.

somewhat clearer attention a relation of events which, if true, must overthrow every cherished opinion of his worth, and which bore so alarming an affinity to his own history of himself--her feelings were yet more acutely painful and more difficult of definition.

Astonishment, apprehension, and even horror, oppressed her. She wished to discredit it entirely, repeatedly exclaiming, "This must be false! This cannot be! This must be the grossest falsehood!"--and when she had gone through the whole letter, though scarcely knowing anything of the last page or two, put it hastily away, protesting that she would not regard it,

that she would never look in it again.

In this perturbed state of mind, with thoughts that could rest on nothing, she walked on; but it would not do; in half a minute the letter was unfolded again, and collecting herself as well as she could, she again began the mortifying perusal of all that related to Wickham, and commanded herself so far as to examine the



Fig. 7.4.11.2 Snapshot of Scroll Pages



7.4.12 Tools

Tools represents a group of assistant functions for better reading.



7.4.12.1 Search

Search for the pattern in current document. The search results in a screen are highlighted.

quite such a Servants Hall full to feed, as I have.-And I do believe those are best off, that have fewest Servants.-I am not a Woman of Parade, as all the World knows, and if it was not for what I owe to poor Mr. Hollis's memory, I should never keep up Sanditon House is I do; -it is not for my own pleasure.-Well Mr. Parker-and the other is a Boarding school, a French Boarding School, is it? -No harm in that.- They'll stay their six weeks.

And out of such a number, who knows but some may be consumptive and want Asses milk-and I have two Milch asses at this present time.-But perhaps the little



Fig. 7.4.12.1 (1) Input Search Pattern

seemed protecting kindness, on the other grateful and affectionate respect.-The Conversation turned entirely upon Sanditon, its present number of Visitants and the Chances of a good Season. It **was** evident that Lady D. had more anxiety, more fears of loss, than her Coadjutor. She wanted to have the Place fill faster, and seemed to have many harassing apprehensions of the Lodgings being in some instances underlet.-Miss Diana Parker's two large Families were not forgotten. 'Very good, very good,' said her Ladyship.-'A West Indy Family and a school. That sounds well.

That will bring Money.'-'No people spend more freely, I believe, than W. Indians,' observed Mr. Parker. 'Aye-so I have heard-and because they have full Purses, fancy themselves equal, may be, to your old Country Families. But then, they who scatter their Money so freely, never think of whether they may not be doing mischief by raising the price of Things-And I have heard that's very much the case with your West-injines-and if they come among us to raise the price of our necessaries of Life, we shall not much thank them Mr. Parker.'-'My dear Madam, They can only raise

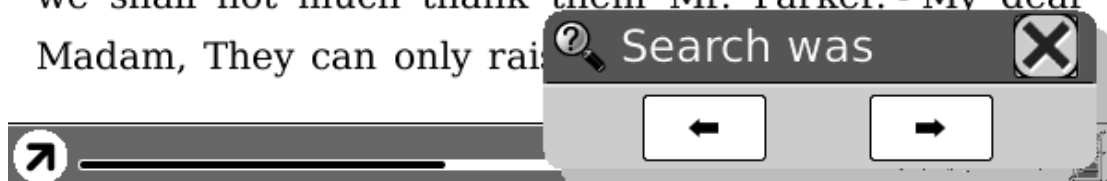

Fig. 7.4.12.1 (2) Display Search Results

instantly resolved to be false; and his account of the real, the worst objections to the match, made her too angry to have any wish of doing him justice. He expressed no regret for **what** he had done which satisfied her; his style was not penitent, but haughty. It was all pride and insolence.

But when this subject was succeeded by his account of Mr. Wickham--when she read with some **what** clearer attention a relation of events which, if true, must overthrow every cherished opinion of his worth, and which bore so alarming an affinity to his own history of himself--her feelings were yet more acutely painful and more difficult of definition. Astonishment, apprehension, and even horror, oppressed her. She wished to discredit it entirely, repeatedly exclaiming, "This must be false! This cannot be! This must be the grossest falsehood!"--and when she had gone through the whole letter, though she had read nothing of the last page, she turned away, protesting that she

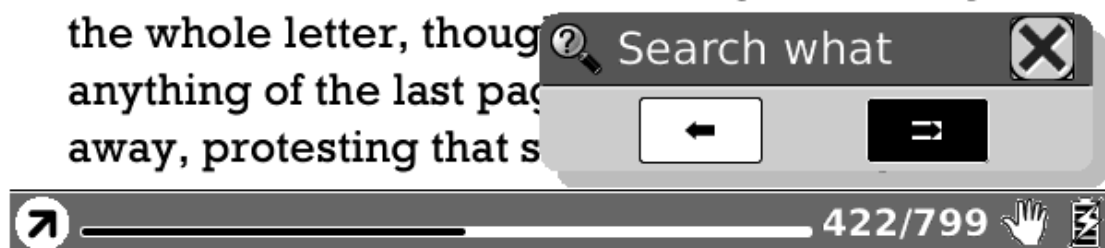

Fig. 7.4.12.1 (3) Search for Next Results



7.4.12.2 Dictionary Lookup

Look up for the explanation of a pattern string.

and the mere stateliness of money or rank she thought she could witness without trepidation.

From the entrance-hall, of which Mr. Collins pointed out, with a rapturous air, the fine proportion and the finished ornaments, they followed the servants through an ante-chamber, to the room where Lady Catherine, her daughter, and Mrs.

Jenkinson were sitting. Her ladyship, with great condescension, arose to receive them; and as Mrs. Collins had settled it with her husband that the office of introduction should be hers, it was performed in a proper manner, without any of those apologies and thanks which he would have thought necessary.

In spite of having been at St. James's Sir William was so completely awed by the grandeur

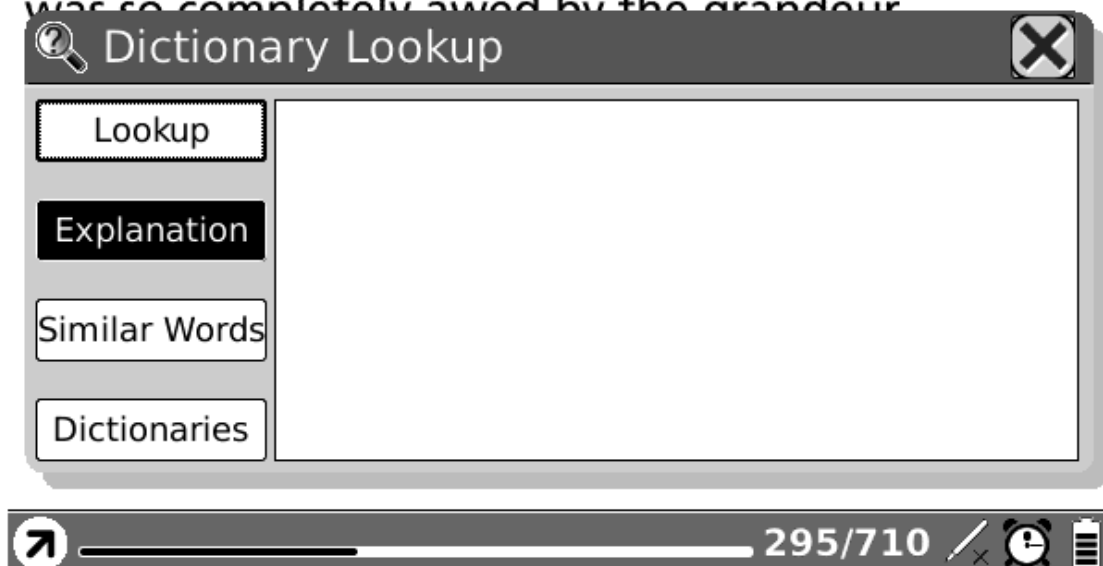

Fig. 7.4.12.2 (1) Popup Dictionary Lookup Dialog

that she would never look in it again.

In this perturbed state of mind, with thoughts that could rest on nothing, she walked on; but it would not do; in half a minute the letter was unfolded again, and collecting herself as well as she could, she again began the mortifying perusal of all that related to Wickham, and commanded herself so far as to examine the meaning of every **sentence**. The account of his connection with the Pemberley family was exactly what he had related himself; and the kindness of the late Mr. Darcy, though she had not before known its extent, agreed equally well with his own words. So far each recital confirmed the other; but when she came to the

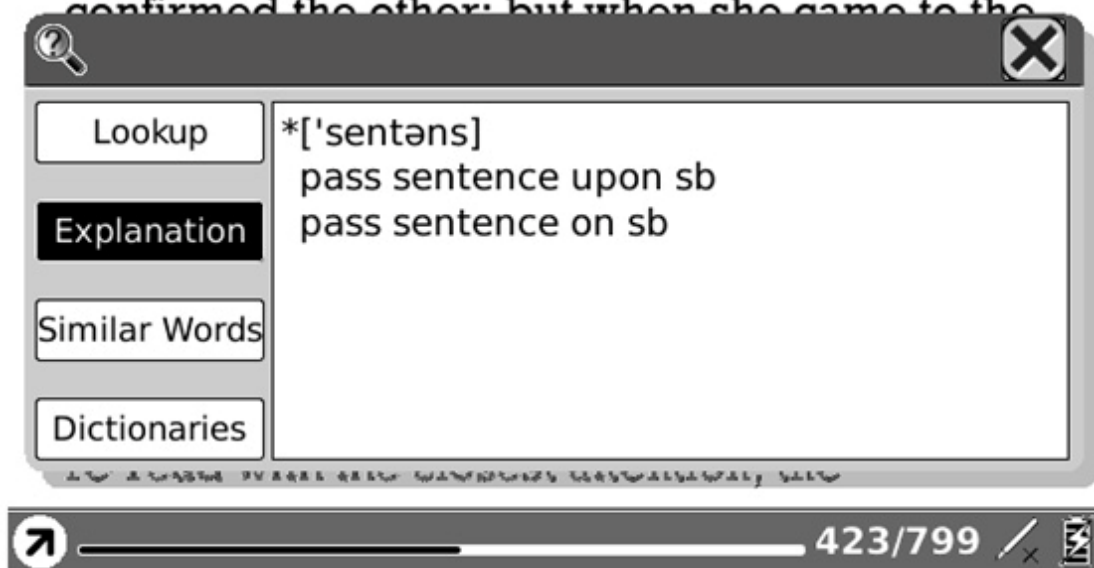

Fig. 7.4.12.2 (2) Select a Word on Content Area



7.4.12.3 Add Bookmark

Add a bookmark of current page.

that she would never look in it again.

In this perturbed state of mind, with thoughts that could rest on nothing, she walked on; but it would not do; in half a minute the letter was unfolded again, and collecting herself as well as she could, she again began the mortifying perusal of all that related to Wickham, and commanded herself so far as to examine the meaning of every sentence. The account of his connection with the Pemberley family was exactly what he had related himself; and the kindness of the late Mr. Darcy, though she had not before known its extent, agreed equally well with his own words. So far each recital confirmed the other; but when she came to the will, the difference was great. What Wickham had said of the living was fresh in her memory, and as she recalled his very words, it was impossible not to feel that there was gross duplicity on one side or the other; and, for a few moments, she flattered herself that her wishes did not err. But when she read and re-read with the closest attention, the



Fig. 7.4.12.3 Snapshot of Adding Bookmark



7.4.12.4 Delete Bookmark

Delete the bookmark of current page.



7.4.12.5 Show Bookmarks

Show all bookmarks in a list view. The front text portion as well as the number of the bookmarked page is displayed in an item. You can jump to the target page by selecting the bookmark item.

Bookmarks		
Title		Page
that she would never look in it again.	I...	423

Fig. 7.4.12.5 Snapshot of Bookmarks View

**7.4.12.6 Hand Tool**

Select the hand tool item in the menu to enable browsing through document by stylus.

**7.4.12.7 Previous View**

Select previous/next view to retrace the path within a document. Select item Previous View to return to previous screen while browsing document.

**7.4.12.8 Next View**

Select item Next View to go to next screen while browsing document. This button is activated only if you have chosen Previous View.

**7.4.12.9 Go To Page**

Select item Go To Page to be able to enter a page number to go directly to the page you want within a document.

**7.4.12.10 Slide Show**

Continuously display the pages of a document (or documents, e.g. images files) by slide show. By clicking Back- button, the slide show will stop.



7.4.12.11 Thumbnail View

Display the images by thumbnail view. Now the thumbnails are displayed by two columns and 2 rows.



holy.png

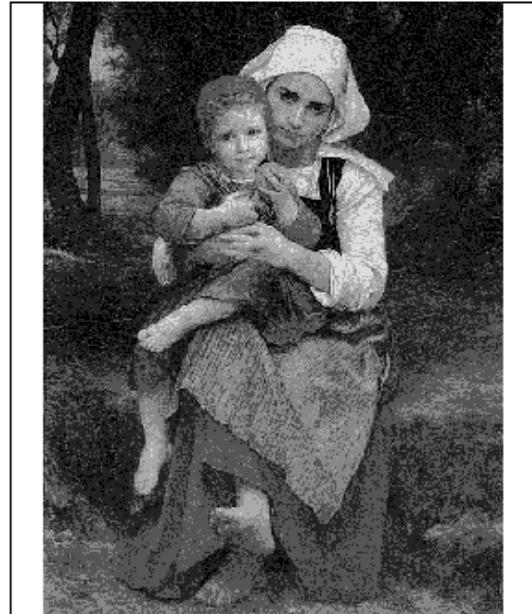

mother.png

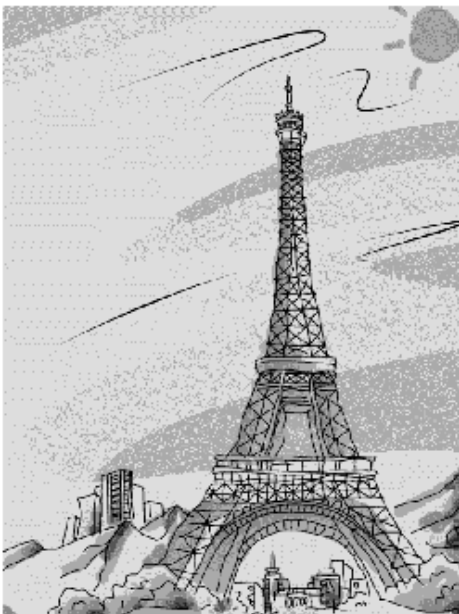

Tower.PNG



wolf.png



Fig. 7.4.12.11 Snapshot of Thumbnail View



7.4.12.12 Table of Content

Display the table of content of the current document by list view. You can jump to a target page by selecting an item.

Title	Page
MCIMX31 and MCIMX31L Applications Pro...	1
Contents	3
About This Book	31
Book I: i.MX31 and i.MX31L Integration a...	53
Chapter 1 Introduction to the i.MX31 a...	55
1.1 Architectural Overview	55
1.1.1 High-Level Block Diagram	56
1.2 Hardware Modules	58
1.2.1 System Control	59
1.2.2 ARM11 Platform	59
1.2.3 Standard System Function...	59
1.2.4 Multimedia and Human Int...	59
1.2.5 Peripherals	60
1.2.6 Special Functional Blocks	60
1.2.7 Detailed Block Diagram	60
1.2.8 Applications Processor (AR...	61
1.2.9 Interrupts	63
1.2.10 External Memory Interfac...	64
1.2.11 Clock Power Management...	64



7.4.12.13 Select Background (of Notepad)

Select background of notepad. The new background replaces the previous one in current page.



7.4.12.14 Export

Export all of the pages in a notepad to SD card. The exported images are saved in the folder called 'notes' on SD card.



7.4.12.15 Insert Page

Insert a new page before current one.



7.4.12.16 Remove Page

Remove current page.



7.4.13 Font Family

Configure the font family while viewing a document. The existing font families of BeBook Neo are shown on the menu.

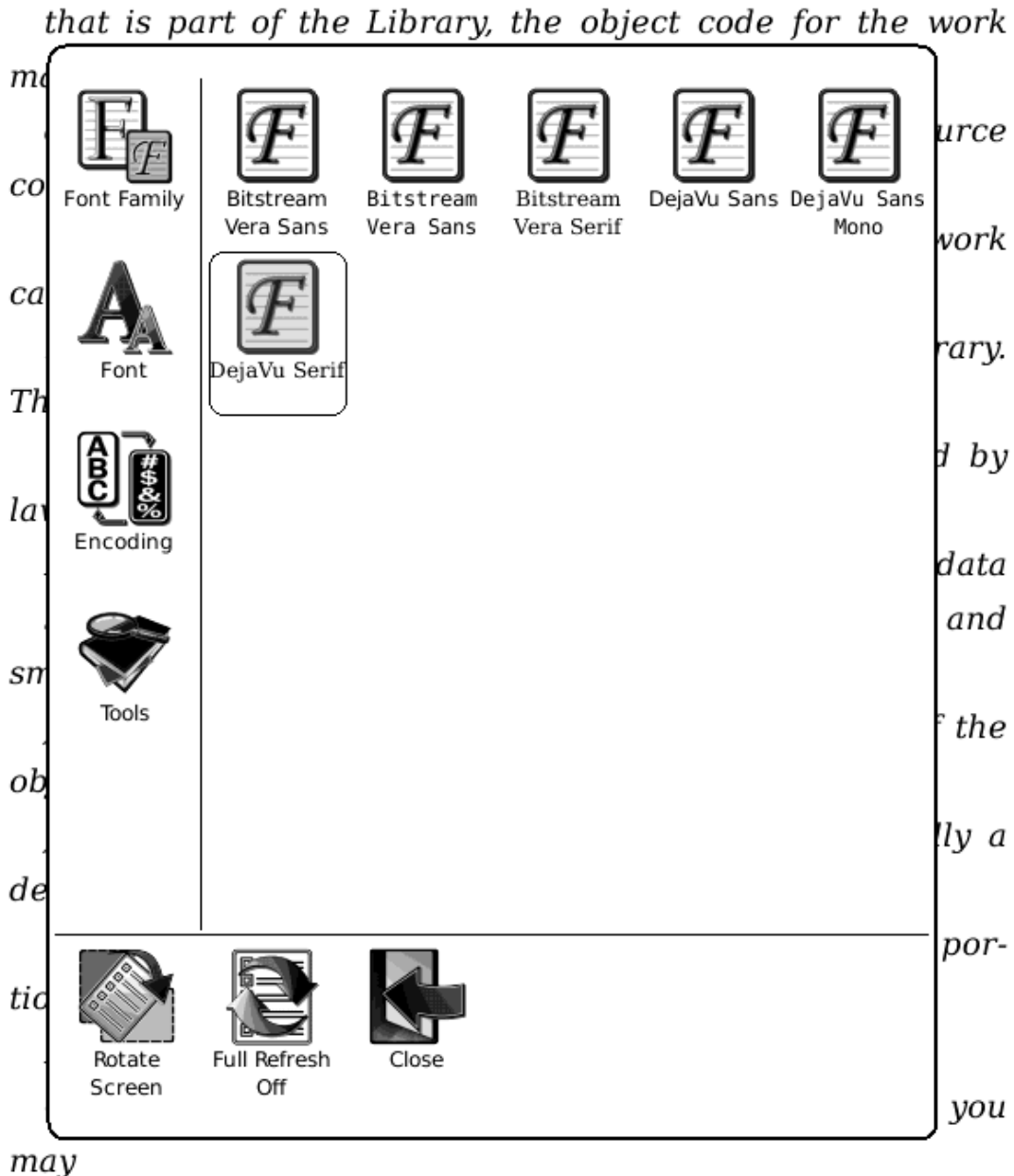

distribute the object code for the work under the terms of

Fig. 7.4.13 Snapshot of Font Family Configuration



7.4.14 Encoding

Configure the encoding type while viewing text-based document. The configurable encoding types are shown on the menu.

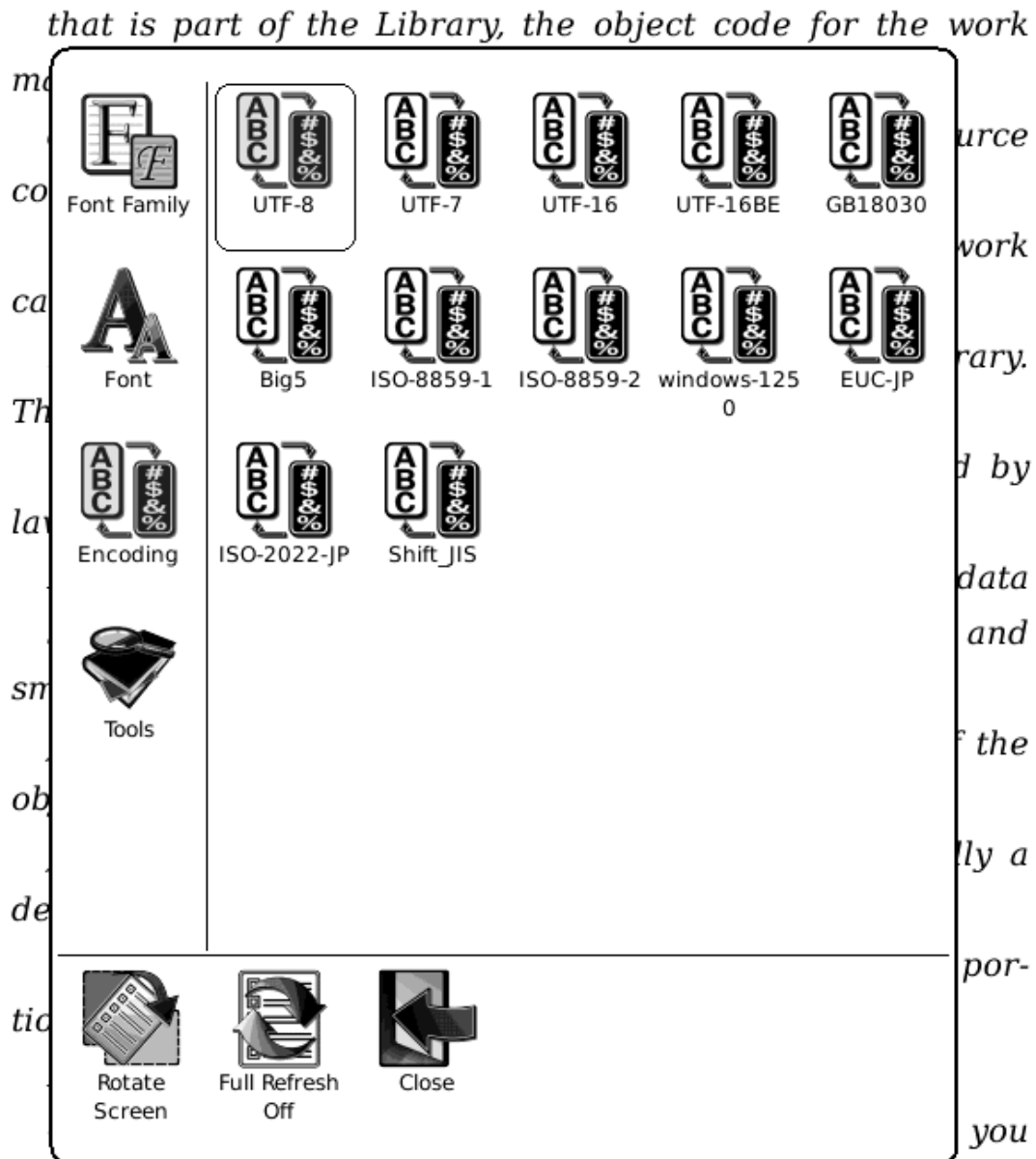

Fig.7.4.14 Snapshot of Encoding Configuration



7.4.15 Full Refresh Switch

Set screen update type. You can turn on/off full refresh.



7.4.16 Navigation

Navigation operations are used for accessing websites and viewing html-based documents, e.g. CHM document.



7.4.16.1 Backward

Go back to previous website.



7.4.16.2 Forward

Go forward to next website. This button is activated only if you have chosen Backward first.



7.4.16.3 Home

Go to the home page.



7.4.17 Network

Configure the network connection.



7.4.17.1 Wifi

Configure the Wifi connection.

7.5 Web Browser

Through built-in web browser, you can access the specified websites.



Fig. 7.5 Snapshot of Web Browser

7.5.1 Tool Bar

Tool bar provides four functions: going back to the previous website, going forward to the next website, refreshing current website, stopping the loading of current page.



6.5.1 Tool Bar of Web Browser

7.5.2 Input by Keyboard

You can input text on website by stylus if the page provides standard form widget. A keyboard appears after you put focus on the form. The input text string is displayed on the form after you confirm the input is done (by clicking OK button).



[Web](#) [Images](#) [Videos](#) [Maps](#) [News](#) [Shopping](#) [Gmail](#) [more ▼](#) [iGoogle](#) | [Search settings](#) | :

Google™

Google Search

I'm Feeling Lucky

[Advertising Programs](#) - [Business Solutions](#) - [About Google](#) - [Go to Google](#)

©2009 - [Privacy](#)

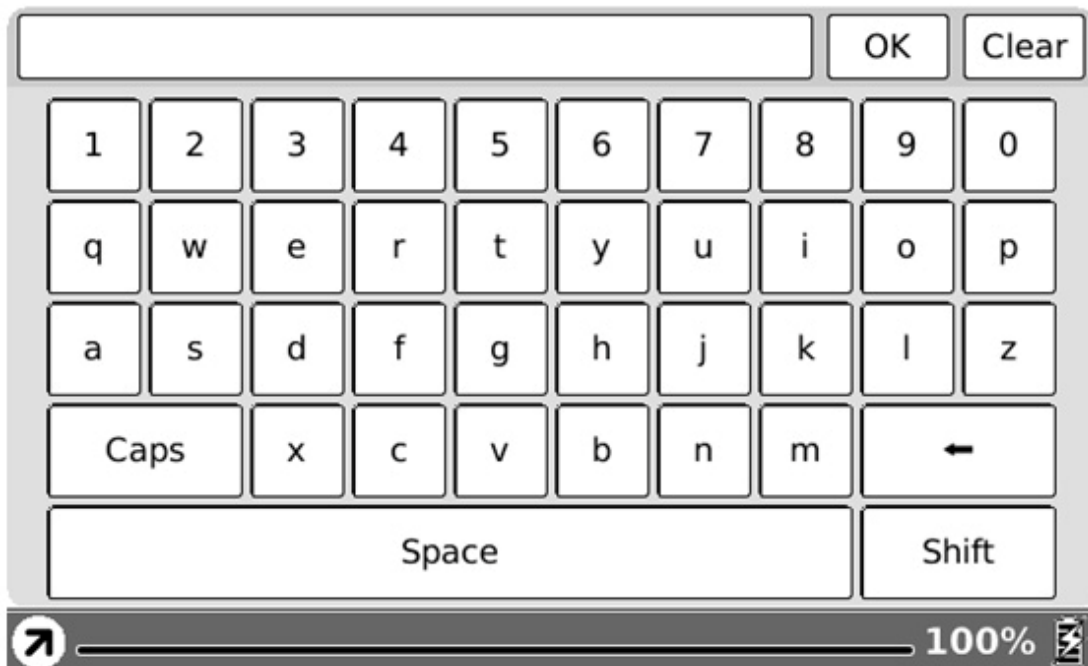

7.5.2 Snapshot of Inputting Text on Website

7.6 Keyboard

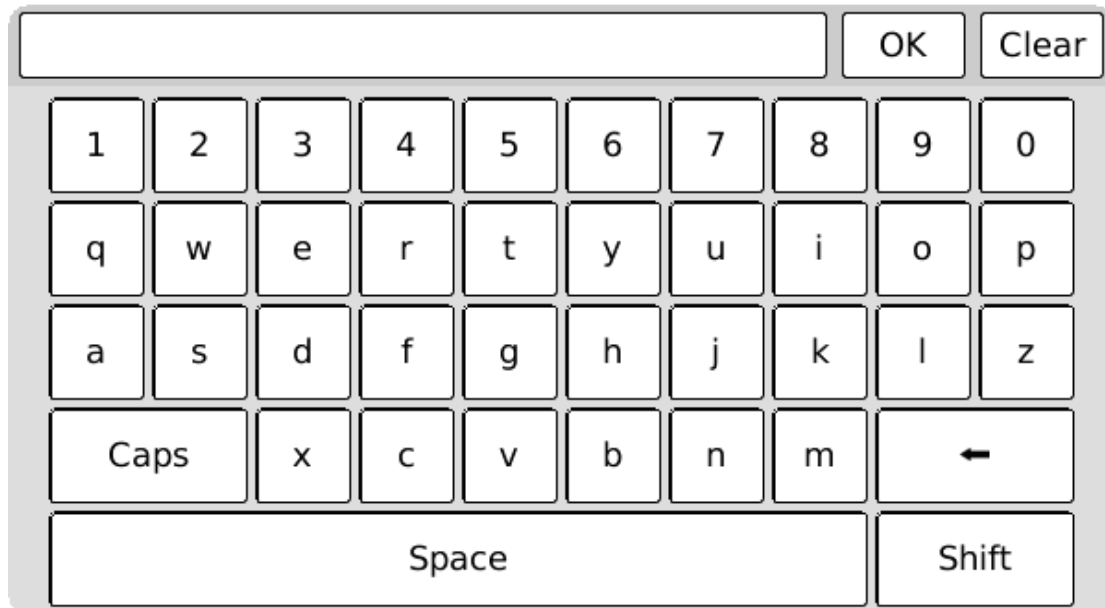

Fig. 7.6 Snapshot of Keyboard

7.6.1 Number Keys

You can input numbers by these keys.

7.6.2 Character Keys

You can input characters by these keys.

7.6.3 Caps Key

Switch all of the characters between lowercase and uppercase.

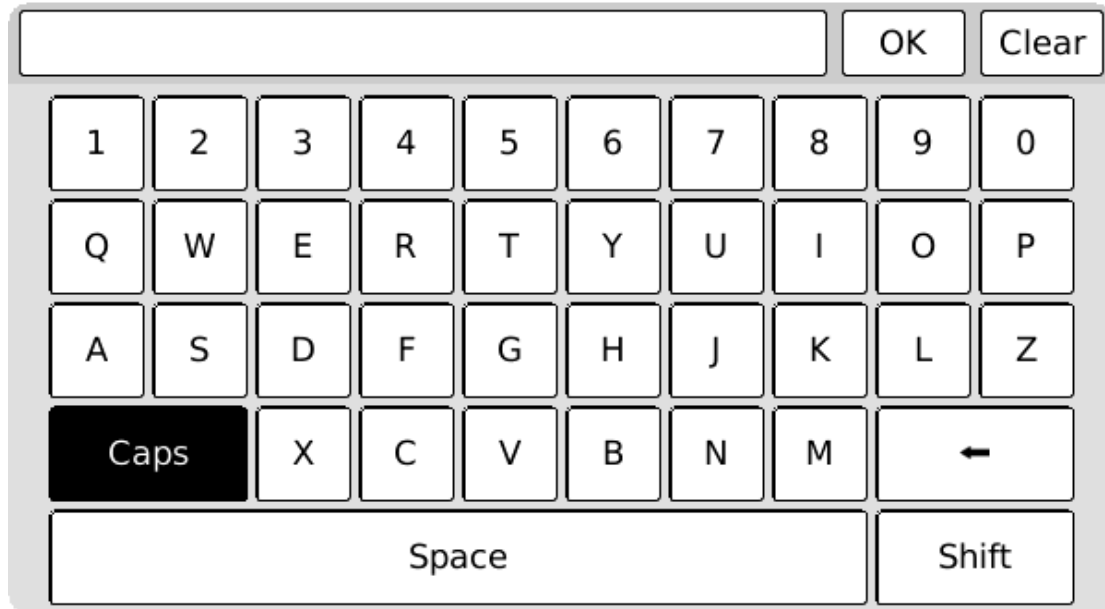

Fig. 7.6.3 Caps is Activated

7.6.4 Backspace

Move the cursor to previous character and remove current one.

7.6.5 Space Key

Insert a space character.

7.6.6 Shift Key

Shift between characters (including numbers) and symbols.

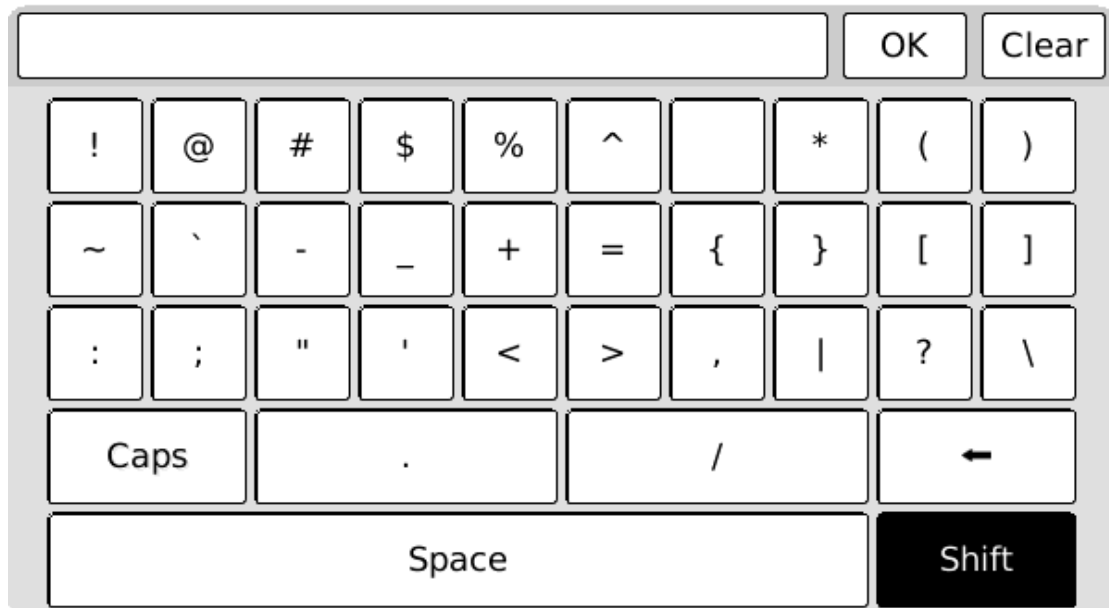

Fig. 7.6.6 Shift Key is Activated

7.7 Search View

Search view is used for inputting the pattern string and other requirements when you search for files or texts.

7.7.1 Free Text Search

quite such a Servants Hall full to feed, as I have.-And I do believe those are best off, that have fewest Servants.-I am not a Woman of Parade, as all the World knows, and if it was not for what I owe to poor Mr. Hollis's memory, I should never keep up Sanditon House is I do; -it is not for my own pleasure.-Well Mr. Parker-and the other is a Boarding school, a French Boarding School, is it? -No harm in that.- They'll stay their six weeks.

And out of such a number, who knows but some may be consumptive and want Asses milk-and I have two Milch asses at this present time.-But perhaps the little

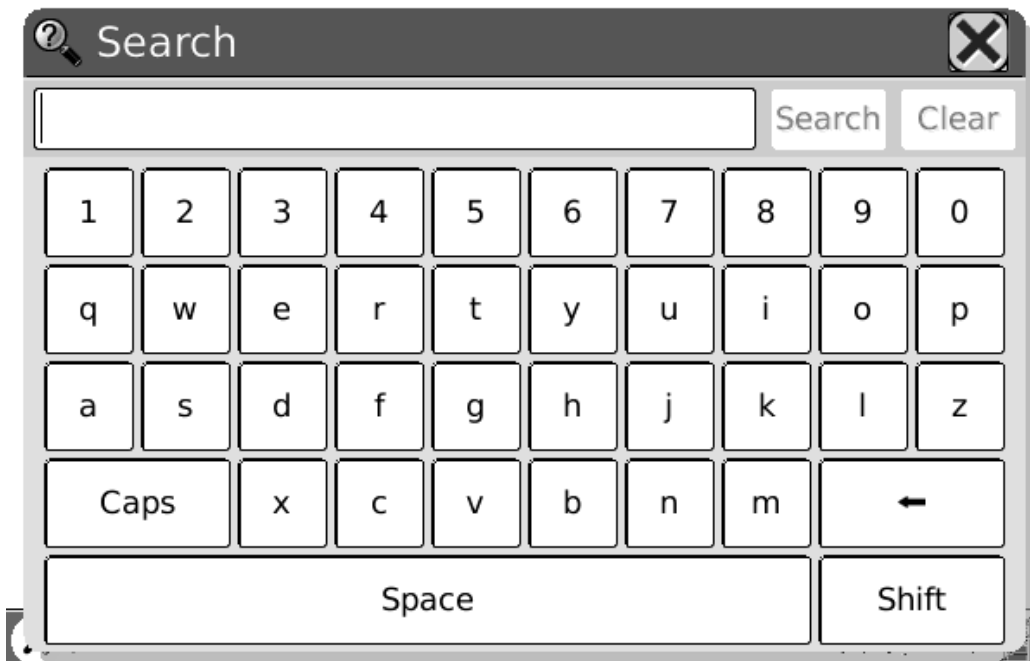

Fig. 7.7.1 Snapshot of Free Text Search

7.7.1.1 Input Box

Display the input pattern string.

7.7.1.2 Search Button

Search starts after clicking this button. The search results of a screen are highlighted.

seemed protecting kindness, on the other grateful and affectionate respect.-The Conversation turned entirely upon Sanditon, its present number of Visitants and the Chances of a good Season. It **was** evident that Lady D. had more anxiety, more fears of loss, than her Coadjutor. She wanted to have the Place fill faster, and seemed to have many harassing apprehensions of the Lodgings being in some instances underlet.-Miss Diana Parker's two large Families were not forgotten. 'Very good, very good,' said her Ladyship.-'A West Indy Family and a school. That sounds well.

That will bring Money.'-'No people spend more freely, I believe, than W. Indians,' observed Mr. Parker. 'Aye-so I have heard-and because they have full Purses, fancy themselves equal, may be, to your old Country Families. But then, they who scatter their Money so freely, never think of whether they may not be doing mischief by raising the price of Things-And I have heard that's very much the case with your West-injines-and if they come among us to raise the price of our necessaries of Life, we shall not much thank them Mr. Parker.'-'My dear Madam, They can only raise

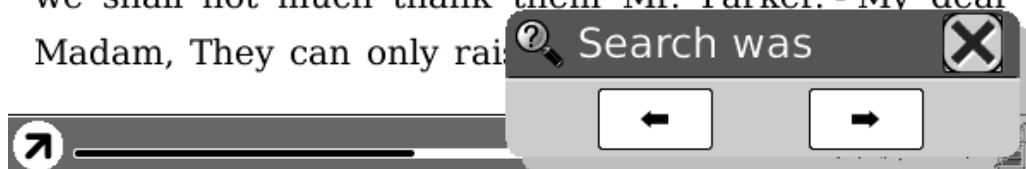

Fig. 7.7.1.2 (1) Search Results of Texts

If no matched result is found, the dialog displays 'No More Matches'.

they had thought themselves so perfectly secure from observation-the whole field open before them-a steep bank and Pales never crossed by the foot of Man at their back- and a great thickness of air, in aid. Yet here, she had seen them. They were really ill-used.-The House **was** large and handsome; two Servants appeared, to admit them, and everything had a suitable air of Property and Order.-Lady D. valued herself upon her liberal Establishment, and had great enjoyment in the order and the Importance of her style of living.-They were shewn into the usual sitting room, well-proportioned and well-furnished; - tho' it **was** Furniture rather originally good and extremely well kept, than new or shewey-and as Lady D. **was** not there, Charlotte had leisure to look about, and to be told by Mrs. P. that the whole-length Portrait of a stately Gentleman, which placed over the Mantlepeice, caught the eye immediately, **was** the picture of Sir H. Denham-and that one among many Miniatures in another part of the room, little conspicuous, represented Mr. Hollis.-Poor Mr. Hollis !



Fig. 7.7.1.2 (2) No More Matches

7.7.1.3 Clear Button

Clear the input pattern string.

7.7.2 File Search

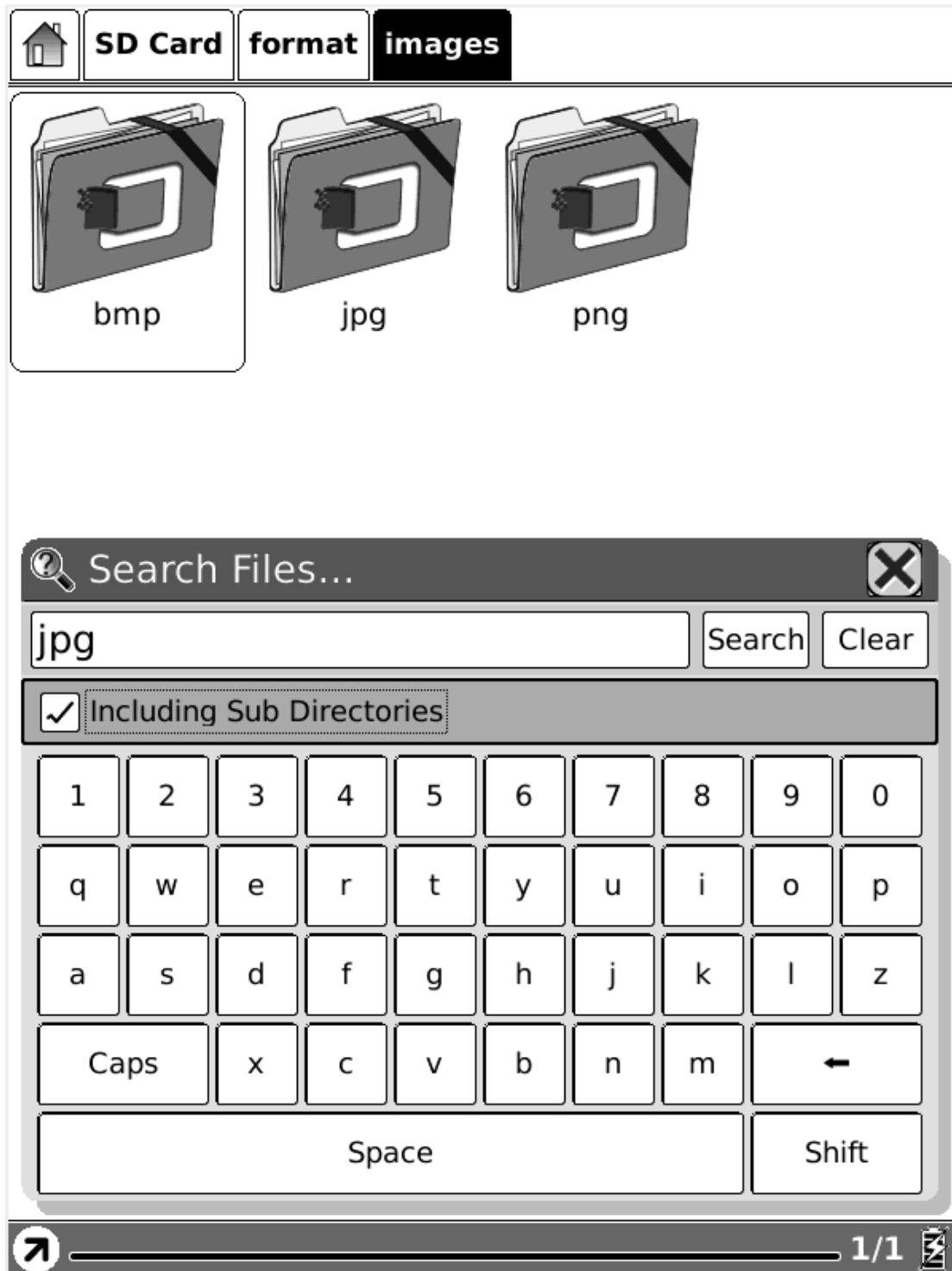

Fig. 7.7.2 Snapshot of File Search

7.7.2.1 Input Box

Display the pattern string used to searching files.

7.7.2.2 Search Button

Search starts after clicking this button. The search results of all matched files are displayed.

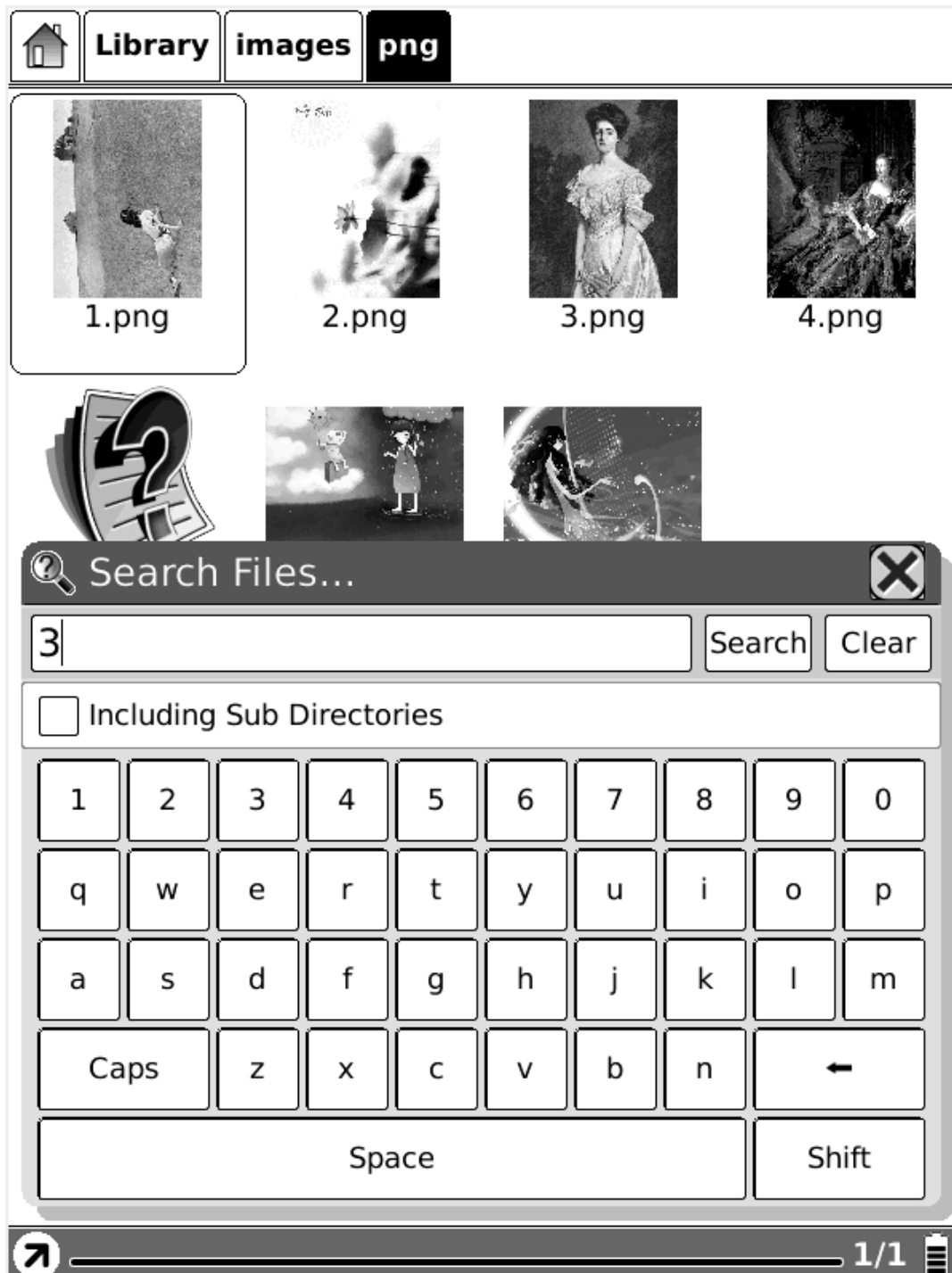

Fig. 7.7.2.2 (1) Search Results of Files

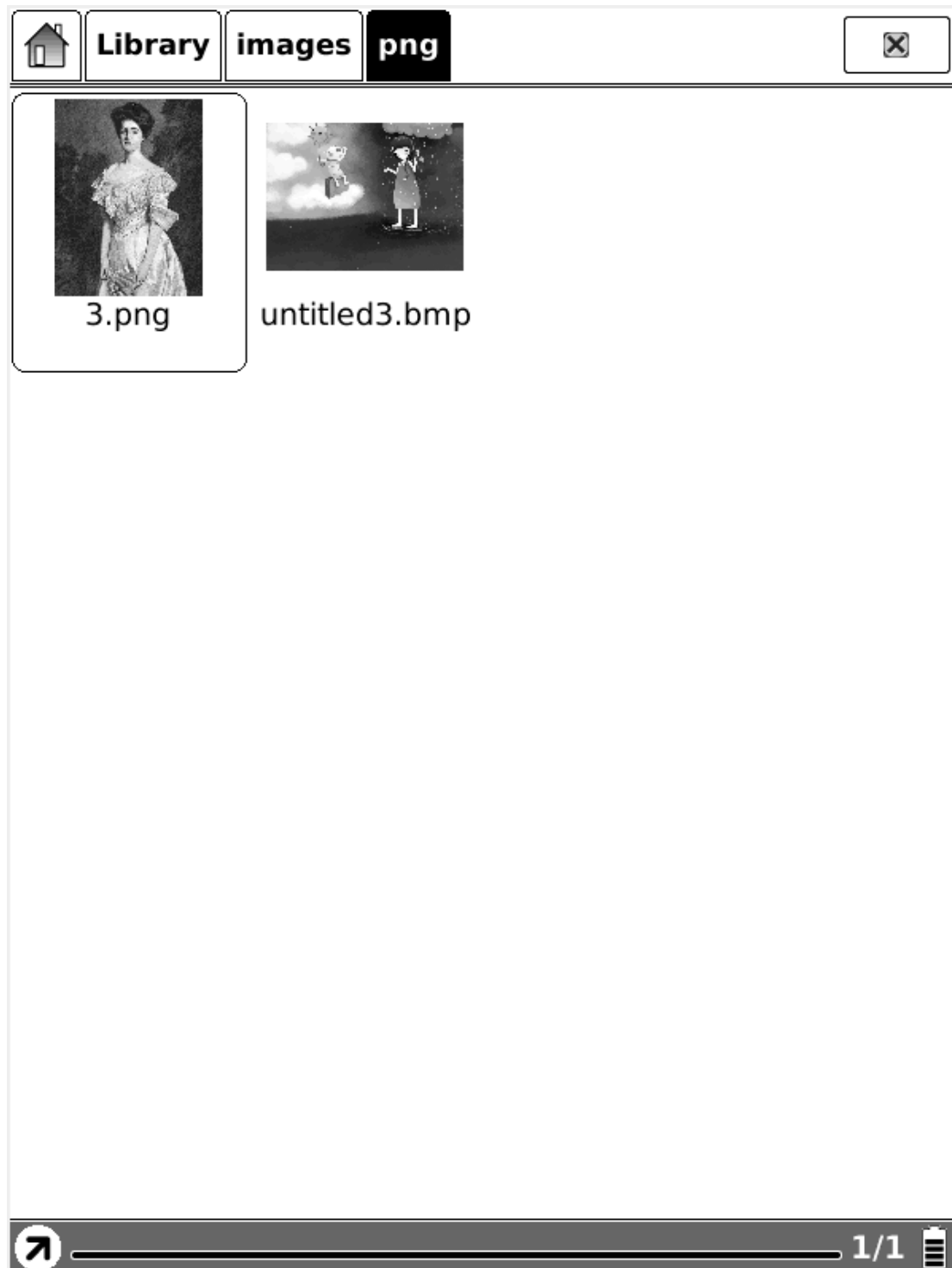

Fig. 7.7.2.2. (2) Search Results of Files

7.7.2.3 Clear Button

Clear the input pattern string.

7.7.2.4 Check Button of Including Subdirectories

Check this button to include the subdirectories for searching.

7.8 Dictionary View (optional)

Dictionary view (optional) is used for translating or explaining a pattern string. You select a string from the texts of current screen, then the translation or explanation of this string displays on the content view.

that she would never look in it again.

In this perturbed state of mind, with thoughts that could rest on nothing, she walked on; but it would not do; in half a minute the letter was unfolded again, and collecting herself as well as she could, she again began the mortifying perusal of all that related to Wickham, and commanded herself so far as to examine the meaning of every sentence. The account of his connection with the Pemberley family was exactly what he had related himself; and the kindness of the late Mr. Darcy, though she had not before known its extent, agreed equally well with his own words. So far each recital confirmed the other; but when she came to the



Fig. 7.8 Dictionary View

7.8.1 Content View

Display the translation or explanation of the pattern string.

7.8.2 Explanation Button

Click this button to display the explanation of the pattern string.

7.8.3 Similar Words Button

Click this button to display the similar words of the pattern string.

7.8.4 Dictionaries Button

Click this button to display the translation of the pattern string.

7.9 Annotations View

Display all of the annotations of the document by list view.

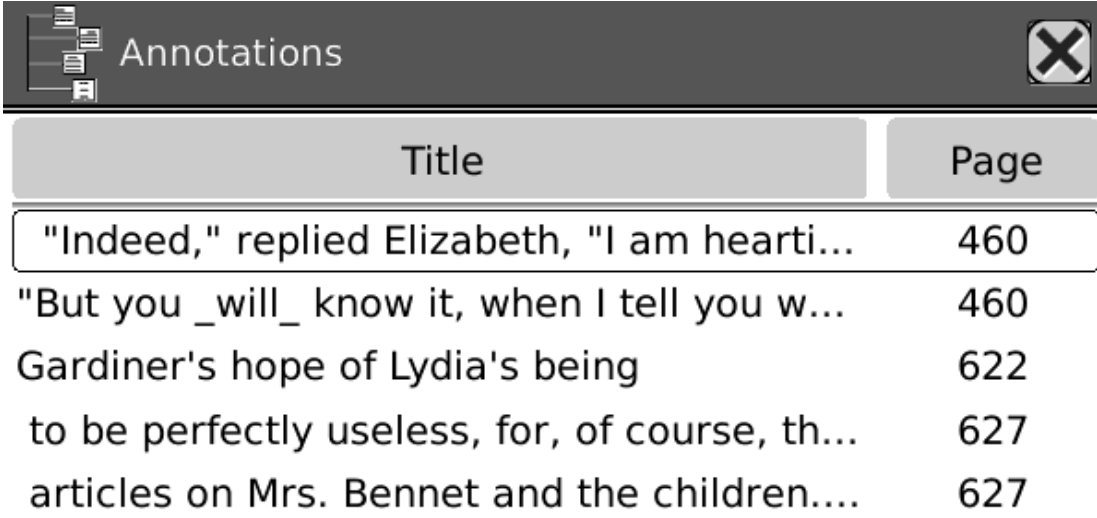

Title	Page
"Indeed," replied Elizabeth, "I am hearti...	460
"But you _will_ know it, when I tell you w...	460
Gardiner's hope of Lydia's being	622
to be perfectly useless, for, of course, th...	627
articles on Mrs. Bennet and the children....	627

1/1

Fig. 7.9 Snapshot of Annotations View

7.10 Bookmarks View

Display all of the bookmarks of the document by list view.

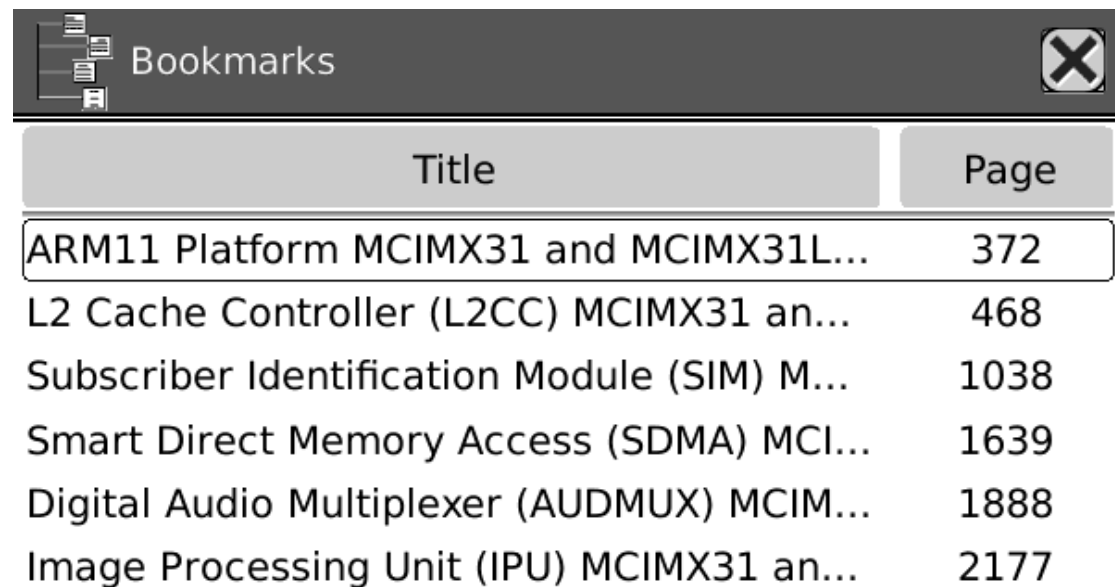

Title	Page
ARM11 Platform MCIMX31 and MCIMX31L...	372
L2 Cache Controller (L2CC) MCIMX31 an...	468
Subscriber Identification Module (SIM) M...	1038
Smart Direct Memory Access (SDMA) MCI...	1639
Digital Audio Multiplexer (AUDMUX) MCIM...	1888
Image Processing Unit (IPU) MCIMX31 an...	2177

Fig. 7.10 Snapshot of Bookmarks View

7.11 Wi-fi Configuration Dialog

Configure the Wi-fi through this dialog. The operations used to activate a Wifi access point are:

- Make sure the Wi-fi switch on the left side of the BeBook Neo is turned on (slide upward).
- BeBook Neo scans the Wi-fi access points around.
- All of the connectable access points are listed.
- Select one of the networks and BeBook Neo starts connecting to it.
- If it is an encrypted access point, a keyboard dialog pops up. You can input password for connection.



Fig. 7.11 Snapshot of Wi-fi Configuration Dialog

7.11.1 Scanning List

List all of the scanned results (wi-fi access points).

7.11.2 Connecting Message Area

Display the current status of connection.

7.11.3 Refresh Button

Click Refresh button to rescan the access points.

7.11.4 Configuring WPA Security Access Point

Input the password for WPA (or WPA2) security access point.



Fig. 7.12.4 Snapshot of Configuring WPA Security Access Point

7.11.5 Configuring WEP Security Access Point

Input the password for WEP security access point.



Fig. 7.12.5 Snapshot of Configuring WEP Security Access Point

8 Sketch

After activating sketch functions (by menu [7.4.9.4](#)), you can make new sketches or erase existing ones.

8.1 Make new sketches

You can sketch on the drawing area by stylus.

continuing their pursuit. When Mrs. Bennet was told of this, she did not express so much satisfaction as her children expected, considering what her anxiety for his life had been before.

"What, is he coming home, and without poor Lydia?" she cried. "Sure he will not leave London before he has found them. Who is to fight Wickham, and make him marry her, if he comes away?"

As Mrs. Gardiner began to wish to be at home, it was settled that she and the children should go to London, at the same time that Mr. Bennet came from it. The coach, therefore, took them the first stage of their journey, and brought its master back to Longbourn.

Mrs. Gardiner went away in all the perplexity about Elizabeth and her Derbyshire friend that had attended her from that part of the world. His name had never been voluntarily mentioned before them by her niece; and the



Fig. 8.1 Snapshot of Sketching

8.2 Erase

You can erase the drawn sketches by stylus. You can click on the stroke or drag across it, then the stroke disappears immediately.

9 Annotation

After activating annotation functions (by menu [6.4.9.1](#)), you can make new annotations or erase existing ones.

9.1 Add Annotation

After selecting function 'Add Annotation', you can highlight the texts you are interested on by dragging the stylus pen. You can also highlight the word by clicking any character of it.

appeared; but consider how much it must increase his disappointment!"

"Indeed," replied Elizabeth, "I am heartily sorry for him; but he has other feelings, which will probably soon drive away his regard for me. You do not blame me, however, for refusing him?"

"Blame you! Oh, no."

"But you blame me for having spoken so warmly of Wickham?"

"No--I do not know that you were wrong in saying what you did."

"But you will know it, when I tell you what happened the very next day."

She then spoke of the letter, repeating the whole of its contents as far as they concerned George Wickham. What a stroke was this for poor Jane! who would willingly have gone



Fig. 8.1 Add Annotation

9.2 Erase Annotations

You can erase an annotation by stylus. You can click on the highlighted area or drag across it, then the annotation is removed.

10 OTA Functionalities

BeBook Neo fully supports Adobe OTA functionalities. You can easily purchase or borrow books from any content provider who uses Adobe Content Server maintaining the DRMed contents.

10.1 Activate BeBook Neo

BeBook Neo must be activated before you use any DRM functionalities, such as purchasing, loaning and returning. The steps of activation are:

1. Get an Adobe ID. You can create an account from the server hosted by the content provider. You can also create it from:
<https://www.adobe.com/cfusion/membership/index.cfm>
2. Go to the online shop of your content provider and start purchasing a book.
3. A dialog of device activation pops up letting you fill in your Adobe ID and password, as shown in Fig. 10.1.

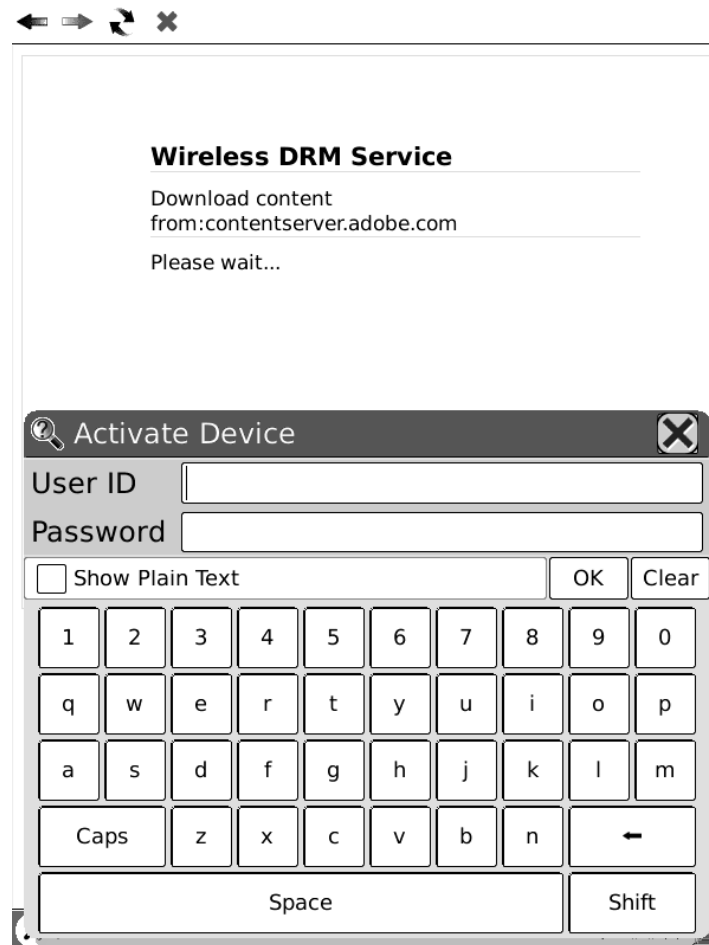

Fig. 10.1 Activate BeBook Neo

Note: If your device has been activated by ADE, you only need to sign in. A sign-in dialog pops up asking you to fill in the password for a given Adobe ID (when you already have used Adobe Digital Editions).

4. The activation starts.
5. Fulfillment of the purchased book starts if activation succeeds.

10.2 Fulfillment

ACS (Adobe Content Server) prepares a DRMed book after you decide to purchase (buy or borrow) it. The book will be downloaded from the server after the DRM process is finished. The whole fulfillment might take several minutes so please wait until it finishes. The web browser displays a "Please wait..." notice during this procedure.

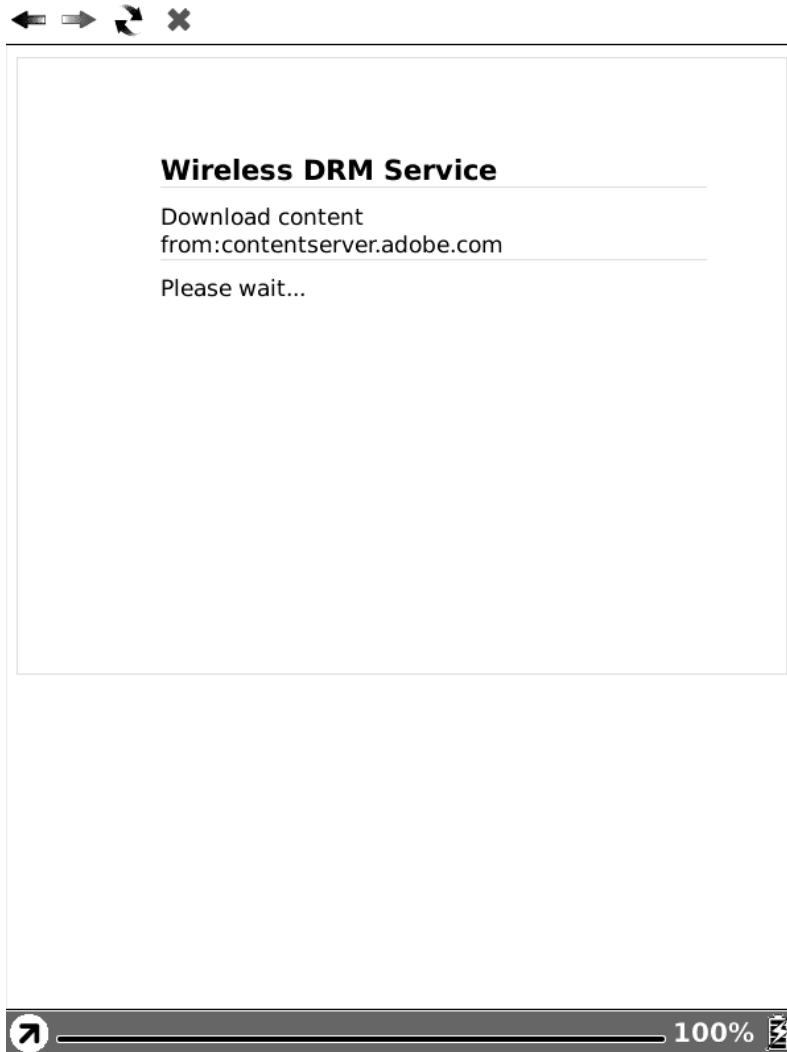

Fig. 10.2 (1) Snapshot of 'Please wait..' message

You will see the success message after fulfillment finishes. A dialog pops up asking you whether opening the book immediately.

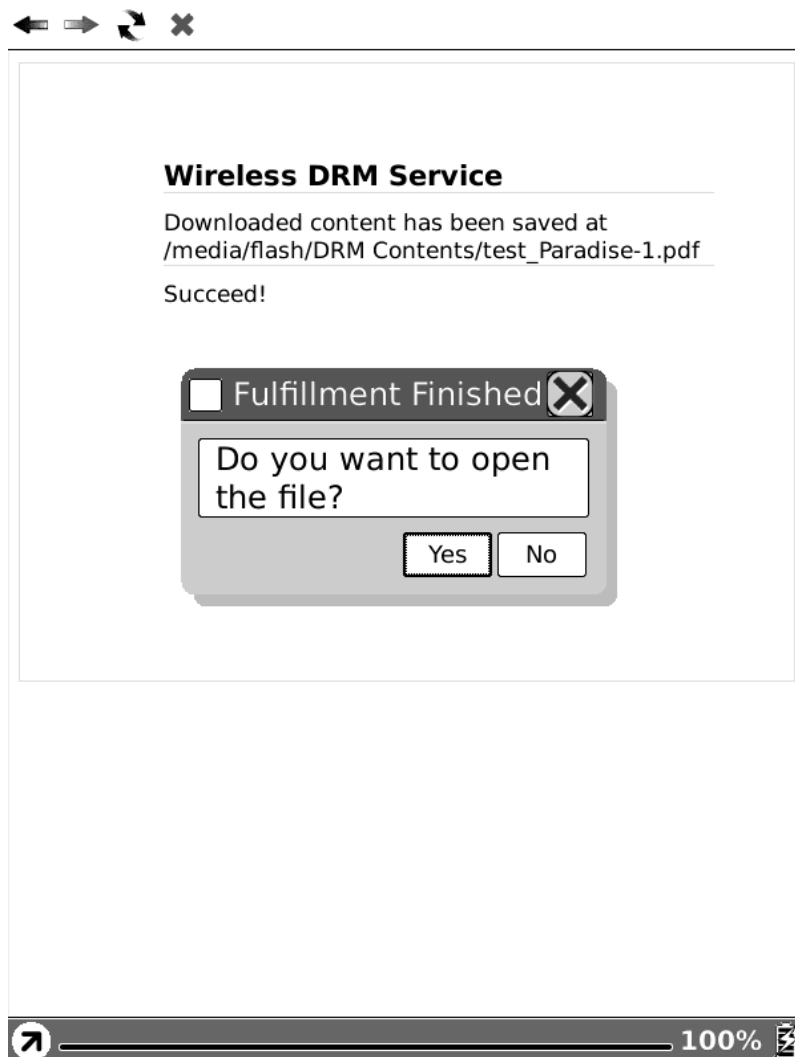

Fig. 10.2 (2) Snapshot of 'Fulfillment Succeed' message

The errors will be displayed if the fulfillment fails by any causes.

10.3 Return a Loaned Book

You can return a borrowed book by selecting “return book” functionality in menu of main view. You need to configure the network before returning it.

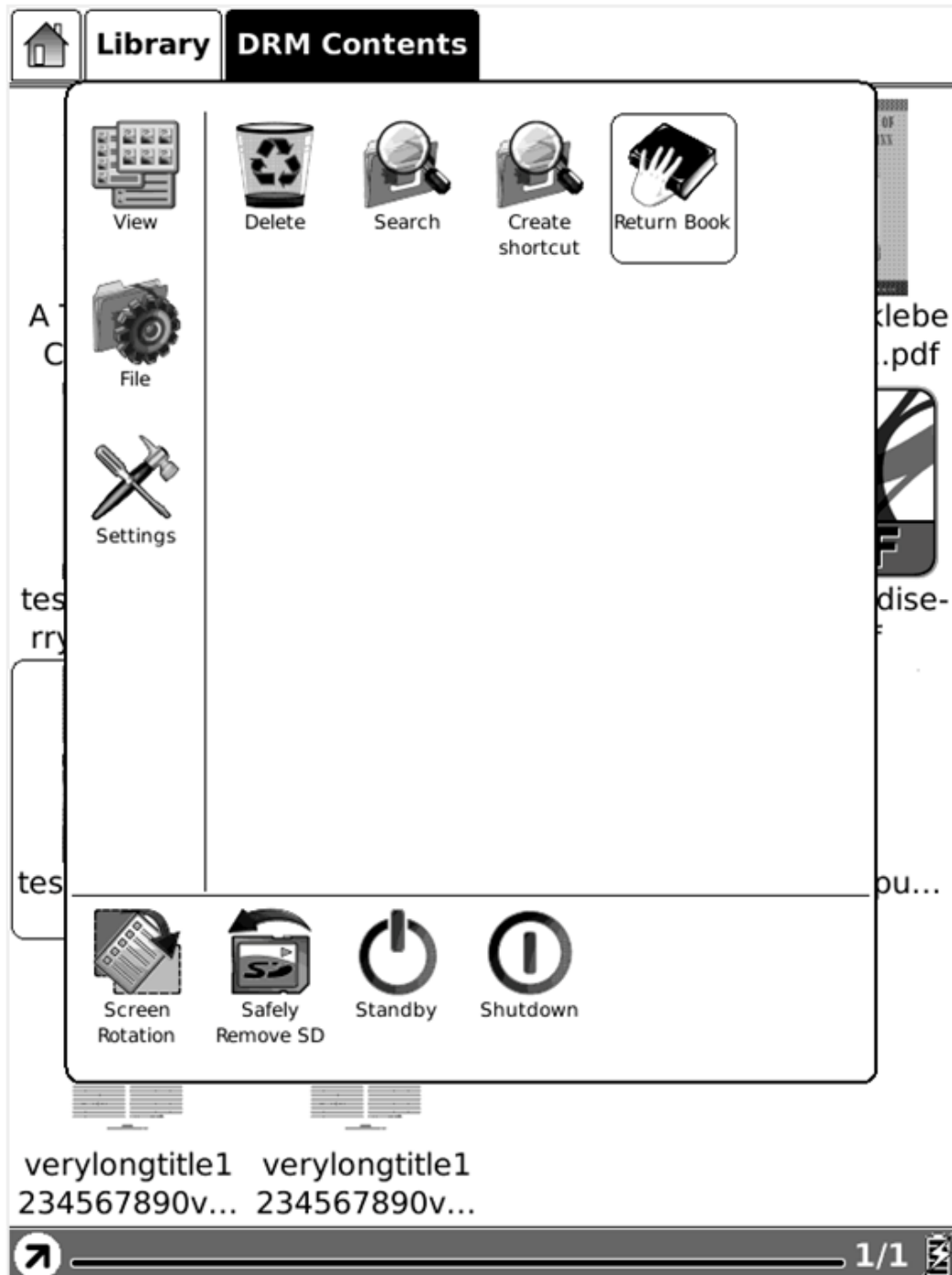

Fig. 10.3 Snapshot of Returning a Book

11 Software Update BeBook Neo

You can update the software by follow steps:

- Download the latest updates package from BeBook website: www.mybebook.com/support
- Save the updates package in a SD card.
- Make sure the updates package is located at the root directory of the SD card. The name should be 'bebook_update.upd'.
- Insert the SD card into BeBook Neo.
- Restart BeBook Neo, press and hold the OK button. NOTE, the OK button should be pressed before the device restarts. Hold it until you see the message 'Software update request detected, checking updates...'
- BeBook Neo updates itself automatically. It restarts after update finishes.

Reminder: Make sure BeBook Neo has enough power to finish the software update (at least 2 grids displayed).

12 Connect to computer

BeBook Neo can be easily connected to PC by USB cable. A dialog pops up immediately after the connection establishes. Select 'Yes' to confirm the connection.

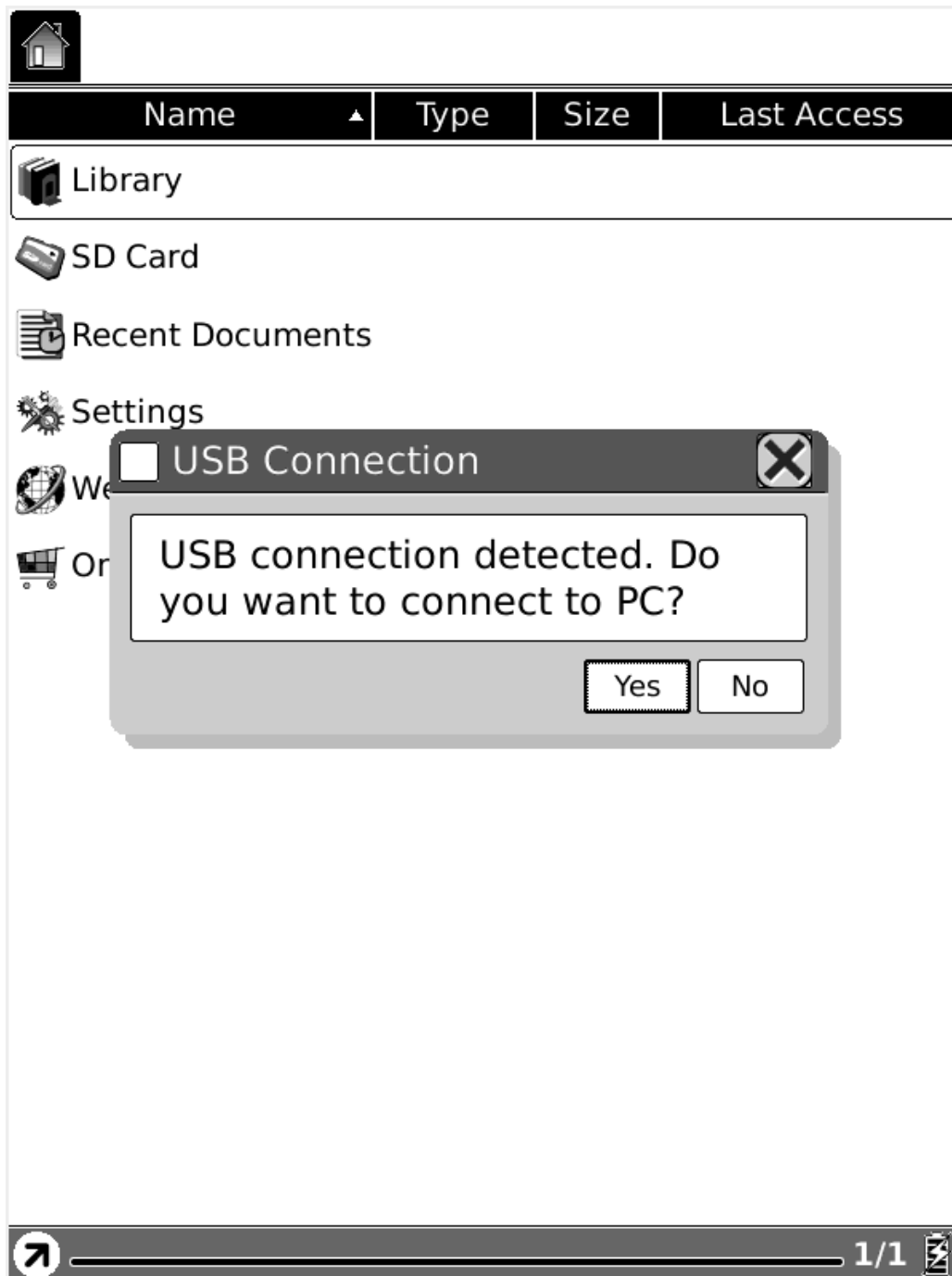

Fig. 12 USB Connection Dialog

You can find at least one removable disk (internal memory of BeBook Neo) on your computer. If you insert SD card in BeBook Neo, the SD card is also displayed as a removable disk.

13 Transfer non-DRM files to BeBook Neo

- Connect your BeBook to your computer as described above.
- The BeBook will be recognized as a USB Mass Storage Device when connection is successfully made.
- You can use Windows Explorer (PC) or Finder (OS) as your BeBook Neo file management program.
- You can now transfer files using the drag-and-drop method as you do with a USB storage key.

14 How to buy eBooks and transfer files with DRM to BeBook Neo

It is recommended to first download and install Adobe© Digital Editions software before you purchase and download any eBooks in .PDF or .ePub format from online bookstores. This program will help you to manage and transfer copy-protected eBooks from your personal computer to your BeBook Neo.

14.1 Download Adobe© Digital Editions

1. Go to www.adobe.com/products/digitaleditions
2. Click on the START INSTALLATION button.
3. Follow the instructions wizard.

14.2 Activation and Authorization

After installation, the Setup Assistant wizard prompts you to activate Adobe© Digital Editions (you must be online during this process). During activation, you have the option to authorize your computer with an Adobe ID.

If you do not have an Adobe ID, creating one is free and only takes a minute.

14.2.1 Adobe ID

The Adobe ID enables you to transfer items protected by digital rights management (DRM) between multiple computers or devices and restore them after a data loss or system reinstallation.

1. Go to www.adobe.com/membership.
2. Click on the CREATE an ADOBE ACCOUNT button.
3. Fill out the membership sign up form. You'll create a new user name and a password.
4. Finish activation of Adobe© Digital Editions software by filling in your Adobe ID.

14.3 BeBook Neo connection with Adobe© Digital Editions

1. Connect the BeBook eReader to your computer and make sure that Adobe© Digital Editions is running. (If you are a MAC user, please first connect your BeBook and after this you may start up Adobe© Digital Editions)
2. Digital Editions automatically detects the presence of your BeBook eReader and offers to authorize it with your Adobe ID.
3. After authorization, the BeBook eReader appears as a new bookshelf in your library. You can read books that are on your BeBook eReader or your own computer.

NOTE:

The first time you connect your BeBook Neo to Digital Editions the program will synchronize all data from the BeBook to your computer. It may seem that your computer is stuck, but this process may take up to 20~30 minutes. Remember, this is only the first time.

14.4 Buying items online

There are various places on the internet from which you can purchase eBooks. Visit our website where you can find our preferred partners and other suggestions:

www.mybebook.com/links

1. Go to your favorite eBook store online.
2. Create an account and login
3. Choose the item(s) you want to purchase
4. Pay for the item(s) using your Credit Card/PayPal account or other payment systems.
5. After the payment is successfully made you will be able to download the item(s). You will see the following dialog box:



6. Click the OPEN button.
7. Adobe© Digital Editions will automatically open on your computer.
8. In Adobe© Digital Editions you will see a dialog box that says: "Downloading" for a (usually) brief period. Then a second dialog box starting "Authorizing content" appears, during which time Adobe© Digital Editions receives the ability to read the item that was just downloaded. Now your item will open.
9. When the BeBook Neo is connected and recognized by Adobe© Digital Editions you can drag and drop the item from your computer bookshelf to your BeBook bookshelf.

For more details about Adobe© Digital Editions, please visit the Adobe website:
www.adobe.com

15 Transfer non-DRM files to BeBook Neo

- Connect your BeBook to your computer as described above.
- The BeBook will be recognized as a USB Mass Storage Device when connection is successfully made.
- You can use Windows Explorer (PC) or Finder (OS) as your BeBook Neo file management program.
- You can now transfer files using the drag-and-drop method as you do with a USB storage key.

16 Help

Use hard reset to solve software issues

Sometimes it is necessary to do a hard reset to erase all of the information in the temporary memory and regain functionality of your BeBook Neo when it stops responding. For example, doing a hard reset is helpful if your BeBook quits responding, you cannot get your BeBook to come out of sleep mode, or if a content causes the BeBook Neo to freeze.

Performing a hard reset

To perform a hard reset, follow the steps below:

1. Push the reset button on the back of the unit with a paperclip for two seconds.
2. Your BeBook Neo will restart automatically.

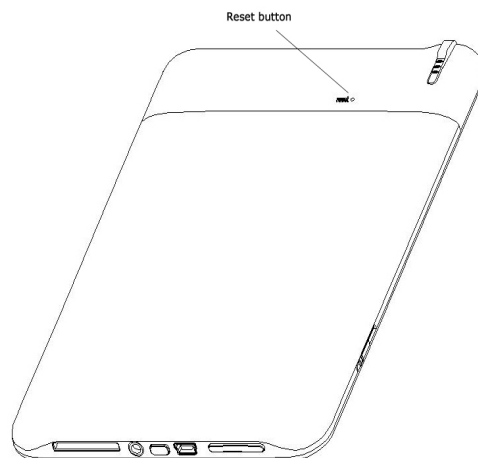

Visit the BeBook forum for support: www.mybebook.com/forum

You may need only simple instructions to correct a problem with your product. If the problem cannot be solved with the troubleshooting information available on-line, you will be offered service through Endless Ideas B.V.

Please **do not** send any products to Endless Ideas B.V. without contacting us first.

If you think you need to return your BeBook Neo for service or malfunction, please visit the following website for detailed instructions:
www.mybebook.com/support

17 Warranty

Your BeBook Neo is guaranteed for a period of 12 months from date of purchase. For full terms and conditions of our Limited Warranty Service please visit:

www.mybebook.com/support

BeBook warranty does not apply to any defect/failure or damage to the screen caused by improper use or inadequate maintenance and care.